





Vision and Voyages for Planetary Science in the Decade 2013-2022

ISBN
978-0-309-20954-0

400 pages
8 1/2 x 11
HARDBACK (2011)

Committee on the Planetary Science Decadal Survey; National Research
Council

 Add book to cart

 Find similar titles

 Share this PDF



Visit the National Academies Press online and register for...

- ✓ Instant access to free PDF downloads of titles from the
 - NATIONAL ACADEMY OF SCIENCES
 - NATIONAL ACADEMY OF ENGINEERING
 - INSTITUTE OF MEDICINE
 - NATIONAL RESEARCH COUNCIL
- ✓ 10% off print titles
- ✓ Custom notification of new releases in your field of interest
- ✓ Special offers and discounts

Distribution, posting, or copying of this PDF is strictly prohibited without written permission of the National Academies Press. Unless otherwise indicated, all materials in this PDF are copyrighted by the National Academy of Sciences. Request reprint permission for this book

PREPUBLICATION COPY
Subject to Further Editorial Correction

Vision and Voyages for Planetary Science in the Decade 2013-2022

Committee on the Planetary Science Decadal Survey
Space Studies Board
Division on Engineering and Physical Sciences
NATIONAL RESEARCH COUNCIL
OF THE NATIONAL ACADEMIES

THE NATIONAL ACADEMIES PRESS
Washington, D.C.
www.nap.edu

PREPUBLICATION COPY—SUBJECT TO FURTHER EDITORIAL CORRECTION

THE NATIONAL ACADEMIES PRESS 500 Fifth Street, N.W. Washington, DC 20001

NOTICE: The project that is the subject of this report was approved by the Governing Board of the National Research Council, whose members are drawn from the councils of the National Academy of Sciences, the National Academy of Engineering, and the Institute of Medicine. The members of the committee responsible for the report were chosen for their special competences and with regard for appropriate balance.

Support for this project was provided by Contract NNH06CE15B between the National Academy of Sciences and the National Aeronautics and Space Administration and Grant AST-1050744 between the National Academy of Sciences and the National Science Foundation. Any opinions, findings, conclusions, or recommendations expressed in this material are those of the authors and do not necessarily reflect the views of the agencies that provided support for the project.

International Standard Book Number-13: 978-0-309-XXXXX-X

International Standard Book Number-10: 0-309-XXXXX-X

Cover design by Penny E. Margolskee

Copies of this report are available free of charge from:

Space Studies Board
National Research Council
The Keck Center of the National Academies
500 Fifth Street, N.W.
Washington, DC 20001

Additional copies of this report are available from the National Academies Press, 500 Fifth Street, N.W., Lockbox 285, Washington, DC 20055; (800) 624-6242 or (202) 334-3313 (in the Washington metropolitan area); Internet, <http://www.nap.edu>.

Copyright 2011 by the National Academy of Sciences. All rights reserved.

Printed in the United States of America

PREPUBLICATION COPY—SUBJECT TO FURTHER EDITORIAL CORRECTION

THE NATIONAL ACADEMIES

Advisers to the Nation on Science, Engineering, and Medicine

The **National Academy of Sciences** is a private, nonprofit, self-perpetuating society of distinguished scholars engaged in scientific and engineering research, dedicated to the furtherance of science and technology and to their use for the general welfare. Upon the authority of the charter granted to it by the Congress in 1863, the Academy has a mandate that requires it to advise the federal government on scientific and technical matters. Dr. Ralph J. Cicerone is president of the National Academy of Sciences.

The **National Academy of Engineering** was established in 1964, under the charter of the National Academy of Sciences, as a parallel organization of outstanding engineers. It is autonomous in its administration and in the selection of its members, sharing with the National Academy of Sciences the responsibility for advising the federal government. The National Academy of Engineering also sponsors engineering programs aimed at meeting national needs, encourages education and research, and recognizes the superior achievements of engineers. Dr. Charles M. Vest is president of the National Academy of Engineering.

The **Institute of Medicine** was established in 1970 by the National Academy of Sciences to secure the services of eminent members of appropriate professions in the examination of policy matters pertaining to the health of the public. The Institute acts under the responsibility given to the National Academy of Sciences by its congressional charter to be an adviser to the federal government and, upon its own initiative, to identify issues of medical care, research, and education. Dr. Harvey V. Fineberg is president of the Institute of Medicine.

The **National Research Council** was organized by the National Academy of Sciences in 1916 to associate the broad community of science and technology with the Academy's purposes of furthering knowledge and advising the federal government. Functioning in accordance with general policies determined by the Academy, the Council has become the principal operating agency of both the National Academy of Sciences and the National Academy of Engineering in providing services to the government, the public, and the scientific and engineering communities. The Council is administered jointly by both Academies and the Institute of Medicine. Dr. Ralph J. Cicerone and Dr. Charles M. Vest are chair and vice chair, respectively, of the National Research Council.

www.national-academies.org

PREPUBLICATION COPY—SUBJECT TO FURTHER EDITORIAL CORRECTION

Other Recent Reports of the Space Studies Board

Capabilities for the Future: An Assessment of NASA Laboratories for Basic Research (Laboratory Assessments Board [LAB] with the Space Studies Board [SSB] and the Aeronautics and Space Engineering Board [ASEB], 2010)

Controlling Cost Growth of NASA Earth and Space Science Missions (SSB, 2010)

Defending Planet Earth: Near-Earth-Object Surveys and Hazard Mitigation Strategies: Final Report (SSB with ASEB, 2010)

An Enabling Foundation for NASA's Space and Earth Science Missions (SSB, 2010)

Life and Physical Sciences Research for a New Era of Space Exploration: An Interim Report (SSB with ASEB, 2010)

New Worlds, New Horizons in Astronomy and Astrophysics (Board on Physics and Astronomy [BPA] and SSB, 2010)

Panel Reports—New Worlds, New Horizons in Astronomy and Astrophysics [prepublication version] (BPA and SSB, 2010)

Revitalizing NASA's Suborbital Program: Advancing Science, Driving Innovation, and Developing a Workforce (SSB, 2010)

America's Future in Space: Aligning the Civil Space Program with National Needs (SSB with ASEB, 2009)

Approaches to Future Space Cooperation and Competition in a Globalizing World: Summary of a Workshop (SSB with ASEB, 2009)

Assessment of Planetary Protection Requirements for Mars Sample Return Missions (SSB, 2009)

Near-Earth Object Surveys and Hazard Mitigation Strategies: Interim Report (SSB with ASEB, 2009)

A Performance Assessment of NASA's Heliophysics Program (SSB, 2009)

Radioisotope Power Systems: An Imperative for Maintaining U.S. Leadership in Space Exploration (SSB with ASEB, 2009)

Ensuring the Climate Record from the NPOESS and GOES-R Spacecraft: Elements of a Strategy to Recover Measurement Capabilities Lost in Program Restructuring (SSB, 2008)

Launching Science: Science Opportunities Provided by NASA's Constellation System (SSB with ASEB, 2008)

Opening New Frontiers in Space: Choices for the Next New Frontiers Announcement of Opportunity (SSB, 2008)

Science Opportunities Enabled by NASA's Constellation System: Interim Report (SSB with ASEB, 2008)

Severe Space Weather Events—Understanding Societal and Economic Impacts: A Workshop Report (SSB, 2008)

Space Science and the International Traffic in Arms Regulations: Summary of a Workshop (SSB, 2008)

Assessment of the NASA Astrobiology Institute (SSB, 2007)

An Astrobiology Strategy for the Exploration of Mars (SSB with the Board on Life Sciences [BLS], 2007)

Building a Better NASA Workforce: Meeting the Workforce Needs for the National Vision for Space Exploration (SSB with ASEB, 2007)

Decadal Science Strategy Surveys: Report of a Workshop (SSB, 2007)

Earth Science and Applications from Space: National Imperatives for the Next Decade and Beyond (SSB, 2007)

Exploring Organic Environments in the Solar System (SSB with the Board on Chemical Sciences and Technology, 2007)

Grading NASA's Solar System Exploration Program: A Midterm Review (SSB, 2007)

The Limits of Organic Life in Planetary Systems (SSB with BLS, 2007)

NASA's Beyond Einstein Program: An Architecture for Implementation (SSB with BPA, 2007)

Options to Ensure the Climate Record from the NPOESS and GOES-R Spacecraft: A Workshop Report (SSB, 2007)

A Performance Assessment of NASA's Astrophysics Program (SSB with BPA, 2007)

Portals to the Universe: The NASA Astronomy Science Centers (SSB, 2007)

The Scientific Context for Exploration of the Moon (SSB, 2007)

Limited copies of SSB reports are available free of charge from

Space Studies Board
National Research Council
The Keck Center of the National Academies
500 Fifth Street, N.W., Washington, DC 20001
(202) 334-3477/ssb@nas.edu
www.nationalacademies.org/ssb/ssb.html

COMMITTEE ON THE PLANETARY SCIENCE DECADAL SURVEY

Steering Group

STEVEN SQUYRES, Cornell University, *Chair*
LAURENCE A. SODERBLOM, U.S. Geological Survey, *Vice Chair*
WENDY M. CALVIN, University of Nevada, Reno
DALE CRUIKSHANK, NASA Ames Research Center
PASCALE EHRENFREUND, George Washington University
G. SCOTT HUBBARD, Stanford University
WESLEY T. HUNTRESS, Jr., Carnegie Institution of Washington (retired) (until November, 2009)
MARGARET G. KIVELSON, University of California, Los Angeles
B. GENTRY LEE, NASA Jet Propulsion Laboratory
JANE LUU, Massachusetts Institute of Technology Lincoln Laboratory
STEPHEN MACKWELL, Lunar and Planetary Institute
RALPH L. McNUTT, JR., Johns Hopkins University Applied Physics Laboratory
HARRY Y. McSWEEN, JR., University of Tennessee, Knoxville
GEORGE A. PAULIKAS, Aerospace Corporation (retired) (from January, 2010)
AMY SIMON-MILLER, NASA Goddard Spaceflight Center
DAVID STEVENSON, California Institute of Technology
A. THOMAS YOUNG, Lockheed Martin Corporation (retired)

Inner Planets Panel

ELLEN R. STOFAN, Proxemy Research, *Chair*
STEPHEN MACKWELL, Lunar and Planetary Institute, *Vice Chair*
BARBARA A. COHEN, NASA Marshall Space Flight Center
MARTHA S. GILMORE, Wesleyan University
LORI GLAZE, NASA Goddard Space Flight Center
DAVID H. GRINSPOON, Denver Museum of Nature and Science
STEVEN A. HAUCK II, Case Western Reserve University
AYANNA M. HOWARD, Georgia Institute of Technology
CHARLES K. SHEARER, University of New Mexico
DOUGLAS S. STETSON, Space Science and Exploration Consulting Group
EDWARD M. STOLPER, California Institute of Technology
ALLAN H. TREIMAN, Lunar and Planetary Institute

Mars Panel

PHILIP R. CHRISTENSEN, Arizona State University, *Chair*
WENDY M. CALVIN, University of Nevada, Reno, *Vice Chair*
RAYMOND E. ARVIDSON, Washington University
ROBERT D. BROWN, Georgia Institute of Technology (until February 2010)
GLENN E. CUNNINGHAM, Jet Propulsion Laboratory (retired)
DAVID DES MARAIS, NASA Ames Research Center (until August 2010)
LINDA T. ELKINS-TANTON, Massachusetts Institute of Technology
FRANCOIS FORGET, Universite de Paris
JOHN P. GROTZINGER, California Institute of Technology
PENELOPE KING, University of New Mexico
PHILIPPE LOGNONNE, Institute de Physique du Globe de Paris
PAUL R. MAHAFFY, Goddard Institute for Space Studies
LISA M. PRATT, Indiana University

PREPUBLICATION COPY—SUBJECT TO FURTHER EDITORIAL CORRECTION

Giant Planets Panel

HEIDI B. HAMMEL, Space Science Institute, *Chair*
AMY SIMON-MILLER, NASA Goddard Space Flight Center, *Vice Chair*
RETA F. BEEBE, New Mexico State University
JOHN R. CASANI, Jet Propulsion Laboratory
JOHN CLARKE, Boston University
BRIGETTE HESMAN, University of Maryland
WILLIAM B. HUBBARD, University of Arizona
MARK S. MARLEY, National Aeronautics and Space Administration
PHILIP D. NICHOLSON, Cornell University
R. WAYNE RICHIE, National Aeronautics and Space Administration (retired)
KUNIO M. SAYANAGI, California Institute of Technology

Satellites Panel

JOHN SPENCER, Southwest Research Institute, *Chair*
DAVID J. STEVENSON, California Institute of Technology, *Vice Chair*
GLENN FOUNTAIN, Johns Hopkins University
CAITLIN ANN GRIFFITH, University of Arizona
KRISHAN KHURANA, University of California, Los Angeles
CHRISTOPHER P. McKAY, National Aeronautics and Space Administration
FRANCIS NIMMO, University of California, Santa Cruz
LOUISE M. PROCKTER, Johns Hopkins University, Applied Physics Laboratory
GERARLD SCHUBERT, University of California, Los Angeles
THOMAS R. SPILKER, Jet Propulsion Laboratory
ELIZABETH P. TURTLE, Johns Hopkins University, Applied Physics Laboratory
HUNTER WAITE, University of Michigan

Primitive Bodies Panel

JOSEPH F. VEVERKA, Cornell University, *Chair*
HARRY Y. McSWEEN, JR., University of Tennessee, Knoxville, *Vice Chair*
ERIC ASPHAUG, University of California, Santa Cruz
MICHAEL E. BROWN, California Institute of Technology
DONALD E. BROWNLEE, University of Washington
MARC BUIE, Southwest Research Institute
TIMOTHY J. McCOY, Smithsonian Institution
MARC D. RAYMAN, Jet Propulsion Laboratory
EDWARD REYNOLDS, Johns Hopkins University
MARK SEPHTON, Imperial College London
JESSICA SUNSHINE, University of Maryland, College Park
FAITH VILAS, MMT Observatory

STAFF

DAVID H. SMITH, Senior Program Officer, *Study Director*
DWAYNE DAY, Program Officer
ABIGAIL SHEFFER, Associate Program Officer
CATHERINE A. GRUBER, Editor
DIONNA WILLIAMS, Program Associate
LEWIS GROSWALD, Research Associate
RODNEY HOWARD, Senior Program Assistant
ELENA AMADOR, Lloyd V. Berkner Space Policy Intern (2009)
GAVRIELE BETANCOURT-MARTINEZ, Lloyd V. Berkner Space Policy Intern (2010)
JORDAN BOCK, Lloyd V. Berkner Space Policy Intern (2009)
DARA FISHER, Lloyd V. Berkner Space Policy Intern (2010)
ABIGAIL FRAEMAN, Space Policy Intern (2009)
ANDREAS FRICK, Lloyd V. Berkner Space Policy Intern (2010)
ANGIE WOLFGANG, Lloyd V. Berkner Space Policy Intern (2009)

MICHAEL H. MOLONEY, Director, Space Studies Board

SPACE STUDIES BOARD

CHARLES F. KENNEL, Scripps Institution of Oceanography, University of California, San Diego, *Chair*
A. THOMAS YOUNG, Lockheed Martin Corporation (retired), *Vice Chair*
DANIEL N. BAKER, University of Colorado
STEVEN J. BATTEL, Battel Engineering
CHARLES L. BENNETT, Johns Hopkins University
YVONNE C. BRILL, Aerospace Consultant
ELIZABETH R. CANTWELL, Oak Ridge National Laboratory
ANDREW B. CHRISTENSEN, Dixie State College and Aerospace Corporation
ALAN DRESSLER, The Observatories of the Carnegie Institution
JACK D. FELLOWS, University Corporation for Atmospheric Research
FIONA A. HARRISON, California Institute of Technology
JOAN JOHNSON-FREESE, Naval War College
KLAUS KEIL, University of Hawaii
MOLLY K. MACAULEY, Resources for the Future
BERRIEN MOORE III, University of New Hampshire
ROBERT T. PAPPALARDO, Jet Propulsion Laboratory, California Institute of Technology
JAMES PAWELCZYK, Pennsylvania State University
SOROOSH SOROOSHIAN, University of California, Irvine
JOAN VERNIKOS, Thirdaye LLC
JOSEPH F. VEVERKA, Cornell University
WARREN M. WASHINGTON, National Center for Atmospheric Research
CHARLES E. WOODWARD, University of Minnesota
ELLEN G. ZWEIBEL, University of Wisconsin

MICHAEL H. MOLONEY, Director (from April 1, 2010)
RICHARD E. ROWBERG, Interim Director (from March 2, 2009, to March 31, 2010)
MARCIA S. SMITH, Director (until March 1, 2009)
CARMELA J. CHAMBERLAIN, Administrative Coordinator
TANJA PILZAK, Manager, Program Operations
CELESTE A. NAYLOR, Information Management Associate
CHRISTINA O. SHIPMAN, Financial Officer
SANDRA WILSON, Financial Assistant

Preface

Strategic planning activities within NASA's Science Mission Directorate (SMD) draw heavily on reports issued by the National Research Council (NRC), particularly those from the Space Studies Board (SSB). Prime among these SSB inputs is identification of priority science and missions in the so-called decadal surveys. The last such study covering SMD's activities in the planetary sciences, *New Frontiers in the Solar System: An Integrated Exploration Strategy*, was published in 2003. That comprehensive study—the first true decadal strategy for this field—canvassed planetary science activities, listed the key science questions, and recommended specific spacecraft missions for the period 2003-2013. Supplemented by several subsequent SSB studies—e.g., *Opening New Frontiers in Space: Choices for the Next New Frontiers Announcement of Opportunity* (2008), *The Scientific Context for Exploration of the Moon* (2007), and *Grading NASA's Solar System Exploration Program: A Midterm Report* (2007)—the 2003 report provided key guidance for SMD's planetary science programs during the first decade of the 21st century.

The successful implementation of many of the missions recommended in the preceding studies, combined with important discoveries by a variety of ground- and space-based research activities, created the demand for a decadal survey of the planetary sciences. Thus, in December 2008, Edward J. Weiler, NASA's associate administrator for SMD, requested that a new decadal strategy study be initiated (Appendix A). Moreover, the request was seconded by the leadership of the National Science Foundation's (NSF's) Division of Astronomical Sciences. Specific tasks outlined in the request included the following:

- An overview of planetary science—what it is, why it is a compelling undertaking, and the relationship between space- and ground-based planetary science research;
- A broad survey of the current state of knowledge of the solar system;
- An inventory of the top-level science questions that should guide flight programs and supporting research programs;
- Recommendations on the optimum balance among small, medium, and large missions and supporting activities;
- An assessment of NSF-supported infrastructure;
- A discussion of strategic technology development needs and opportunities;
- A prioritized list of major flight investigations in the New Frontiers and larger classes recommended for initiation over the decade 2013-2022;
- Recommendations for supporting research required to maximize the science return from the flight investigations; and
- A discussion of the opportunities for conducting science investigations involving humans in situ and the value of human-tended investigations relative to those performed solely robotically.

In response to this request, the NRC appointed the Committee on the Planetary Science Decadal Survey, consisting of a 16-member steering group and 54 additional experts organized into five topical panels. For reasons of consistency and continuity, the panels were organized according to planetary objects—i.e., inner planets (Mercury, Venus, and the Moon), Mars, giant planets, satellites of the giant planets, and primitive bodies—as in the 2003 planetary decadal survey. Unlike the 2003 survey, however, the present survey omits an astrobiology panel; instead, individuals with appropriate expertise were distributed among the five named panels.

PREPUBLICATION COPY—SUBJECT TO FURTHER EDITORIAL CORRECTION

The study was formally initiated at a meeting of the steering group held in Washington, D.C., on July 6-8, 2009. Work continued at meetings held in Irvine, California (November 16-18 and February 22-24) and concluded with additional meetings in Washington, D.C. (July 13-15 and August 3-4). In parallel with these meetings, the committee's five supporting panels held their own information-gathering and deliberative meetings. Each panel met three times:

- Inner Planets Panel—August 26-28, 2009 (Washington, D.C.), October 26-28, 2009 (Irvine, California), and April 21-23, 2010 (Boulder, Colorado);
- Mars Panel—September 9-11, 2009 (Tempe, Arizona), November 4-6, 2009 (Pasadena, California), and April 14-16, 2010 (Boulder, Colorado);
- Giant Planets Panel—August 24-26, 2009 (Washington, D.C.), October 26-28, 2009 (Irvine, California), and May 5-7, 2010 (Boston, Massachusetts);
- Satellites Panel—August 24-26, 2009 (Washington, D.C.), September 21-23, 2009 (Irvine, California), and April 12-14, 2010 (Boulder, Colorado); and
- Primitive Bodies Panel—September 9-11, 2009 (Washington, D.C.), October 28-30, 2009 (Irvine, California), and April 26-28, 2010 (Knoxville, Tennessee).

The committee made extensive use of teleconferences, e-mail, and password-protected Web sites to facilitate its work. Moreover to ensure the widest possible community participation in the committee's meetings, all were webcast thanks to technical assistance provided by the NASA Astrobiology Institute.

The planetary science community is extremely diverse in its geographical distribution, scientific interests, research techniques and approaches, and institutional affiliations. Thus, it was clear from the study's initiation that the committee must successfully reflect the interests of this community and that, to achieve a broad consensus of opinion in support of the survey's recommendations, it would be necessary to stimulate and consider a wide variety of inputs from the scientific community, from NASA and NSF and their respective advisory committees, from other government agencies, from major universities and research institutes, and from the interested public. Such inputs were obtained through oral presentations made to the committee, through webcasts, and through numerous public forums and town hall sessions at major national and international community meetings, and by stimulating the drafting of a total of 199 community-authored white papers on a wide range of scientific subjects that covered essentially all topics within the decadal survey's purview.¹ To ensure that the white papers would receive appropriate consideration, the committee requested that they be available no later than September 15, 2009, i.e., prior to the steering group's and panels' second meetings.

The panels were responsible for preparing a broad survey of the current state of knowledge of the solar system and for identifying the key scientific questions and measurement objectives most appropriate for being addressed in the period 2013-2023. The panels also assessed current research programs and infrastructure managed by NASA and NSF. Finally, using information in the white papers and from other community inputs, the panels identified a total of 24 priority spacecraft missions capable of addressing key scientific questions for those planetary bodies within their respective purviews.

To ensure that the 24 mission concepts were sufficiently mature for subsequent evaluation and prioritization, the committee commissioned detailed technical studies from several leading design centers, including the Jet Propulsion Laboratory, the NASA Goddard Space Flight Center, and the Johns Hopkins University Applied Physics Laboratory. One or more "science champions," drawn from the ranks of the panels, was attached to each center's study team to ensure that the concepts remained true to the scientific and measurement objectives of their originating panel. In addition, four detailed studies of key technologies were also conducted at the panels' request.

Prior decadal surveys have been criticized for not paying appropriate attention to the fiscal and technical realism of recommended missions. To rectify this shortcoming and to be responsive to the

¹ Available at <http://www8.nationalacademies.org/ssbsurvey/publicview.aspx>.

statement of task's call for "independent and expert cost analysis," the NRC contracted with the Aerospace Corporation to provide cost and technical evaluations of a priority subset of the 24 missions studied by the design centers.

Finally, the panels' various scientific inputs, assessments, and recommendations for new ground- and space-based initiatives were integrated by the steering group. The integration and overall prioritization of new spacecraft initiatives were heavily influenced by the cost and technical evaluations provided by the Aerospace Corporation.

Final drafts of the panel reports were completed in August 2010. The steering group assembled the first full draft of this survey report in September. The text was sent to external reviewers in early October, was revised between December 2010 and February 2011, and was formally approved for release by the NRC on February 23, 2011.

The work of the committee was made easier thanks to the important help given by individuals too numerous to list, at a variety of public and private organizations, who made presentations at committee meetings, drafted white papers, and participated in missions studies. In addition, the following graduate students greatly assisted the work of the committee by taking notes at meetings: Michael Busch, Serina Diniega, Adrienne Dove, Raina Gough, Scott Guzewish, Paul Hayne, Robert Lossing, Kennda Lynch, Andrew Poppe, Kelsi Singer, and Patrick Whelley. Finally, the committee acknowledges the exceptionally important contributions made by the following individuals at the Aerospace Corporation: Randy Persinger (team leader), Mark Barrera, Dave Bearden, Mark Cowdin, Shirin Eftekhazadeh, Debra Emmons, Matt Hart, Robert Kellogg, Eric Mahr, Mark Mueller, Geoffrey Reber, and Carl Rice.

This report has been reviewed in draft form by individuals chosen for their diverse perspectives and technical expertise, in accordance with procedures approved by the NRC's Report Review Committee. The purpose of this independent review is to provide candid and critical comments that will assist the institution in making its published report as sound as possible and to ensure that the report meets institutional standards for objectivity, evidence, and responsiveness to the study charge. The review comments and draft manuscript remain confidential to protect the integrity of the deliberative process.

We wish to thank the following individuals for their participation in the review of this report: Charles Alcock, Harvard-Smithsonian Center for Astrophysics; Kyle T. Alfriend, Texas A&M University; Fran Bagenal, University of Colorado; Richard P. Binzel, Massachusetts Institute of Technology; Roger D. Blandford, Stanford University; Joseph A. Burns, Cornell University; Athena Coustenis, Observatoire de Paris-Meudon; Victoria E. Hamilton, Southwest Research Institute; Harald Hiesinger, Westfälische Wilhelms-Universität; Andrew Ingersoll, California Institute of Technology; N. Jeremy Kasdin, Princeton University; Eugene H. Levy, Rice University; Jonathan I. Lunine, University of Rome Tor Vergata; Alfred McEwen, University of Arizona; John F. Mustard, Brown University; Keith Noll, Space Telescope Science Institute; Carle Pieters, Brown University; and Daniel Scheeres, University of Colorado.

Although the reviewers listed above have provided many constructive comments and suggestions, they were not asked to endorse the conclusions or recommendations, nor did they see the final draft of the report before its release. The review of this report was overseen by Richard A. McCray, University of Colorado, Boulder, and Bernard F. Burke, Massachusetts Institute of Technology. Appointed by the National Research Council, they were responsible for making certain that an independent examination of this report was carried out in accordance with institutional procedures and that all review comments were carefully considered. Responsibility for the final content of this report rests entirely with the authoring committee and the institution.

Contents

EXECUTIVE SUMMARY		ES-1
SUMMARY		S-1
1	INTRODUCTION TO PLANETARY SCIENCE The Motivations for Planetary Science The 2002 Solar System Exploration Decadal Survey Recent Achievements in Planetary Science Scope of This Report Organization of This Report References	1-1
2	NATIONAL AND INTERNATIONAL PROGRAMS IN PLANETARY SCIENCE Relationships Between Planetary Science Programs at NASA and NSF Relationships to Other NASA Science Programs Relationships to Other NSF Programs Relationship to NASA’s Human Exploration Program International Cooperation in Planetary Science References	2-1
3	PRIORITY QUESTIONS IN PLANETARY SCIENCE FOR THE NEXT DECADE Crosscutting Themes Priority Questions Building New Worlds: Understanding Solar System Beginnings Planetary Habitats: Searching for the Requirements of Life Workings of Solar Systems: Revealing Planetary Processes Through Time References	3-1
4	THE PRIMITIVE BODIES: BUILDING BLOCKS OF THE SOLAR SYSTEM Science Goals for the Study of Primitive Bodies Decipher the Record in Primitive Bodies of Epochs and Processes Not Obtained Elsewhere Understand the Role of Primitive Bodies as Building Blocks for Planets and Life Interconnections Supporting Research and Related Activities Instrumentation and Infrastructure Advancing Studies of the Primitive Bodies: 2013-2022 References	4-1
5	THE INNER PLANETS: THE KEY TO UNDERSTANDING EARTH-LIKE WORLDS Science Goals for the Study of Mercury, Venus, and the Moon Understand the Origin and Diversity of Terrestrial Planets Understand How the Evolution of Terrestrial Planets Enables and Limits the Origin and Evolution of Life	5-1

PREPUBLICATION COPY—SUBJECT TO FURTHER EDITORIAL CORRECTION

- Understand the Processes That Control Climate in Order to Constrain Both Long-Term Climate Evolution on Terrestrial Planets and Short-Term Natural and Anthropogenic Forcings on Earth
Interconnections
Supporting Research and Related Activities
Technology Development
Advancing Studies of the Inner Planets: 2013-2022
References
- 6 MARS: EVOLUTION OF AN EARTH-LIKE WORLD 6-1
Science Goals for the Study of Mars
Determine If Life Ever Arose on Mars
Understand the Processes and History of Climate
Determine the Evolution of the Surface and Interior
Interconnections
Importance of Mars Sample Return
Supporting Research and Related Activities
Technology Development
Instrumentation and Infrastructure
Advancing Studies of Mars: 2013-2022
References
- 7 THE GIANT PLANETS: LOCAL LABORATORIES AND 7-1
GROUND TRUTH FOR PLANETS BEYOND
Science Goals for the Study of Giant Planets
Giant Planets as Ground Truth for Exoplanets
Exploring the Giant Planet's Roles in Promoting a Habitable Planetary System
Giant Planets as Laboratories for Properties and Processes on Earth
Interconnections
Supporting Research and Related Activities
Instrumentation and Infrastructure
Advancing Studies of the Giant Planets: 2013-2022
Notes and References
- 8 SATELLITES: ACTIVE WORLDS AND EXTREME ENVIRONMENTS 8-1
Science Goals for Studies of Planetary Satellites
How Did the Satellites of the Outer Solar System Form and Evolve?
What Processes Control the Present-Day Behavior of These Bodies?
What are the Processes That Result in Habitable Environments?
Interconnections
Supporting Research and Related Activities
Instrumentation and Infrastructure
Advancing Studies of the Satellites of the Giant Planets: 2013-2022
References
- 9 RECOMMENDED FLIGHT INVESTIGATIONS: 2013-2022 9-1
Judging Mission and Related Priorities
Underlying Programmatic Requirements
Previously Recommended Missions
Mission Study Process and Technical Evaluation
Definition of Mission Cost Classes

PREPUBLICATION COPY—SUBJECT TO FURTHER EDITORIAL CORRECTION

Balance Among Mission Cost Classes
Small Missions
Prioritized Medium- and Large-Class Flight Missions: 2013-2022
Launch Vehicle Costs
The Need for Plutonium-238
Opportunities for Intraagency, Interagency, and International Collaboration
Notes and References

10	PLANETARY SCIENCE RESEARCH AND INFRASTRUCTURE	10-1
	Supporting Research and Related Activities at NASA	
	NASA Instrumentation and Infrastructure	
	Supporting Research and Related Activities at NSF	
	NSF Instrumentation and Infrastructure	
	Notes and References	
11	THE ROLE OF TECHNOLOGY DEVELOPMENT IN PLANETARY EXPLORATION	11-1
	Technology: Portal into the Solar System	
	Technology Needs	
	Recommended Technology Investments	
12	A LOOK TO THE FUTURE	12-1
	Preparing for the Next Planetary Decadal Survey	
	Note and Reference	

APPENDIXES

- A Letter of Request and Statement of Task
- B Planetary Community White Papers
- C Cost and Technical Evaluation of Priority Missions
- D Other Missions Considered
- E Decadal Planning Wedge for NASA Planetary Science
- F Glossary, Abbreviations, and Acronyms
- G Mission and Technology Study Reports¹

¹ NASA initiated mission studies and technology studies in support of this decadal survey. These reports are available at http://sites.nationalacademies.org/SSB/SSB_059331 and will be supplied (unedited) on a CD, and not in printed form, in the final published report.

Executive Summary

In recent years, planetary science has seen a tremendous growth in new knowledge. Deposits of water ice exist at the Moon's poles. Discoveries on the surface of Mars point to an early warm wet climate, and perhaps conditions under which life could have emerged. Liquid methane rain falls on Saturn's moon Titan, creating rivers, lakes, and geologic landscapes with uncanny resemblances to Earth's. Comets impact Jupiter, producing Earth-sized scars in the planet's atmosphere. Saturn's poles exhibit bizarre geometric cloud patterns and changes; its rings show processes that may help us understand the nature of planetary accretion. Venus may be volcanically active. Jupiter's icy moons harbor oceans below their ice shells: conceivably Europa's ocean could support life. Saturn's tiny moon Enceladus has enough geothermal energy to drive plumes of ice and vapor from its south pole. Dust from comets shows the nature of the primitive materials from which the planets and life arose. And hundreds of new planets discovered around nearby stars have begun to reveal how our solar system fits into a vast collection of others.

This report was requested by NASA and the National Science Foundation (NSF) to review the status of planetary science in the United States and to develop a comprehensive strategy that will continue these advances in the coming decade. Drawing on extensive interactions with the broad planetary science community, the report presents a decadal program of science and exploration with the potential to yield revolutionary new discoveries. The program will achieve long-standing scientific goals with a suite of new missions across the solar system. It will provide fundamental new scientific knowledge, engage a broad segment of the planetary science community, and have wide appeal for the general public whose support enables the program.

A major accomplishment of the committee's recommended program will be taking the first critical steps toward returning carefully selected samples from the surface of Mars. Mars is unique among the planets in having experienced processes comparable to those on Earth during its formation and evolution. Crucially, the martian surface preserves a record of earliest solar system history, on a planet with conditions that may have been similar to those on Earth when life emerged. It is now possible to select a site on Mars from which to collect samples that will address the question of whether the planet was ever an abode of life. The rocks from Mars that we have on Earth in the form of meteorites cannot provide an answer to this question. They are igneous rocks, whereas recent spacecraft observations have shown the occurrence on Mars of chemical sedimentary rocks of aqueous origin, and rocks that have been aqueously altered. It is these materials, none of which are found in meteorites, that provide the opportunity to study aqueous environments, potential prebiotic chemistry, and perhaps, the remains of early martian life.

If NASA's planetary budget is augmented, then the program will also carry out the first in-depth exploration of Jupiter's icy moon Europa. This moon, with its probable vast subsurface ocean sandwiched between a potentially active silicate interior and a highly dynamic surface ice shell, offers one of the most promising extraterrestrial habitable environments in our solar system and a plausible model for habitable environments outside it. The Jupiter system in which Europa resides hosts an astonishing diversity of phenomena, illuminating fundamental planetary processes. While Voyager and Galileo taught us much about Europa and the Jupiter system, the relatively primitive instrumentation of those missions, and the low data volumes returned, left many questions unanswered. Major discoveries surely remain to be made. The first step in understanding the potential of the outer solar system as an abode for life is a Europa

mission with the goal of confirming the presence of an interior ocean, characterizing the satellite's ice shell, and understanding its geological history.

The program will also break new ground deep in the outer solar system. The gas giants Jupiter and Saturn have been extensively studied by the Galileo and Cassini missions, respectively. But Uranus and Neptune represent a wholly distinct class of planet. While Jupiter and Saturn are made mostly of hydrogen, Uranus and Neptune have much smaller hydrogen envelopes. The bulk composition of these planets is dominated instead by heavier elements; oxygen, carbon, nitrogen, and sulfur are the likely candidates. What little we know about the internal structure and composition of these “ice giant” planets comes from the brief flybys of Voyager 2. So the ice giants are one of the great remaining unknowns in the solar system: the only class of planet that has never been explored in detail. The proposed program will fill this gap in our knowledge by initiating a mission to orbit Uranus and put a probe into the planet's atmosphere. It is exploration in the truest sense, with the same potential for new discoveries as Galileo at Jupiter and Cassini at Saturn.

The program described in this report also vigorously continues NASA's two programs of competed planetary missions: New Frontiers and Discovery. It includes seven candidate New Frontiers missions from which NASA will select two for flight in the coming decade. These New Frontiers candidates cover a vast sweep of exciting planetary science questions: The surface composition of Venus, the internal structure of the Moon, the composition of the lunar mantle, the nature of Trojan asteroids, the composition of comet nuclei, the geophysics of Jupiter's volcanic moon Io, and the structure and detailed composition of Saturn's atmosphere. And continuation of the highly successful Discovery program, which involves regular competitive selections, will provide a steady stream of scientific discoveries from small missions that draw on the full creativity of the science community.

Space exploration has become a worldwide venture, and international collaboration has the potential to enrich the program in ways that benefit all participants. The program therefore relies more strongly than ever before on international participation, presenting many opportunities for collaboration with other nations. Most notably, the ambitious and complex Mars Sample Return campaign is critically dependent on a long-term and enabling collaboration with the European Space Agency (ESA).

In order to assemble this program, four criteria were used to select and prioritize missions. The first and most important was science return per dollar. Science return was judged with respect to the key scientific questions identified by the planetary science community; costs were estimated via a careful and conservative procedure that is described in detail in the body of this report. The second was programmatic balance—striving to achieve an appropriate balance among mission targets across the solar system and an appropriate mix of small, medium, and large missions. The other two were technological readiness and availability of trajectory opportunities within the 2013-2022 time period.

In order to help develop its recommendations, the committee commissioned technical studies of many candidate missions that were selected for study on the basis of white papers submitted by the scientific community. A subset of these was chosen on the basis of the four prioritization criteria listed above for independent assessments of technical feasibility, as well as conservative estimates of costs. From these, the committee finalized a set of recommended missions intended to achieve the highest priority science identified by the community within the budget resources projected to be available. It consists of a balanced mix of small Discovery missions, medium-sized New Frontiers missions, and large “Flagship” missions, enabling both a steady stream of new discoveries and the capability to address major challenges. The mission recommendations assume full funding of all missions that are currently in development, and continuation of missions that are currently in flight, subject to approval via the appropriate review process.

SMALL MISSIONS

Missions for NASA's Discovery program lie outside the bounds of a decadal strategic plan, so this report makes no specific Discovery flight mission recommendations. The committee stresses,

PREPUBLICATION COPY—SUBJECT TO FURTHER EDITORIAL CORRECTION

ES-2

however, that the Discovery program has made important and fundamental contributions to planetary exploration, and can continue to do so in the coming decade. Because there is still so much compelling science that can be addressed by Discovery missions, the committee recommends continuation of the Discovery program at its current level, adjusted for inflation, with a cost cap per mission that is also adjusted for inflation from the current value (i.e., to about \$500 million in fiscal year (FY) 2015). And in order for the science community to plan Discovery missions effectively, the committee recommends a regular, predictable, and preferably rapid (≤ 24 month) cadence for Discovery AO releases and mission selections.

An important small mission that lies outside the Discovery program is the proposed joint ESA/NASA Mars Trace Gas Orbiter that would launch in 2016. The committee supports flight of this mission as long as the currently negotiated division of responsibilities and costs with ESA is preserved.

MEDIUM MISSIONS

The current cost cap for NASA's competed New Frontiers missions, inflated to FY2015 dollars, is \$1.05 billion, including launch vehicle costs. The committee recommends changing this cap to \$1.0 billion FY2015, *excluding* launch vehicle costs. This change represents a modest increase in the effective cost cap and will allow a scientifically rich and diverse set of New Frontiers missions to be carried out, and will help protect the science content of the program against increases and volatility in launch vehicle costs.

Two New Frontiers missions have been selected by NASA to date, and a third selection is underway now. The committee recommends that NASA select two New Frontiers missions in the decade 2013-2022. These are referred to here as New Frontiers Mission 4 and New Frontiers Mission 5.

New Frontiers Mission 4 should be selected from among the following five candidates:

- Comet Surface Sample Return,
- Lunar South Pole-Aitken Basin Sample Return,
- Saturn Probe,
- Trojan Tour and Rendezvous, and
- Venus In Situ Explorer.

No relative priorities are assigned to these five candidates; instead, the selection among them should be made on the basis of competitive peer review.

If the third New Frontiers mission selected by NASA addresses the goals of one of these mission candidates, the corresponding candidate should be removed from the above list of five, reducing the number from which NASA should make the New Frontiers Mission 4 selection to four.

For the New Frontiers Mission 5 selection, the following missions should be added to the list of remaining candidates:

- Io Observer,
- Lunar Geophysical Network.

Again, no relative priorities are assigned to any of these mission candidates.

Tables ES.1 and ES.2 summarize the recommended mission candidates and decision rules for the New Frontiers program.

LARGE MISSIONS

The highest priority large mission for the decade 2013-2022 is the Mars Astrobiology Explorer-Cacher (MAX-C), which will begin a three-mission NASA-ESA Mars Sample Return campaign extending into the decade beyond 2022. At an estimated cost of \$3.5 billion as currently designed, however, MAX-C would take up a disproportionate share of the NASA's planetary budget. This high cost results in large part from the goal to deliver two large and capable rovers—a NASA sample-caching rover and the European Space Agency's ExoMars rover—using a single entry, descent, and landing (EDL) system that is derived from the Mars Science Laboratory (MSL) EDL system. Accommodation of two such large rovers would require major redesign of the MSL EDL system, with substantial associated cost growth.

The committee recommends that NASA fly MAX-C in the decade 2013-2022, but only if it can be conducted for a cost to NASA of no more than approximately \$2.5 billion FY2015. If a cost of no more than about \$2.5 billion FY2015 cannot be verified, the mission (and the subsequent elements of Mars Sample Return) should be deferred until a subsequent decade or cancelled.

It is likely that a significant reduction in mission scope will be needed to keep the cost of MAX-C below \$2.5 billion. In order to be of benefit to NASA, the Mars exploration partnership with ESA must involve ESA participation in other missions of the Mars Sample Return campaign. The best way to maintain the partnership will be an equitable reduction in scope of both the NASA and ESA objectives for the joint MAX-C/ExoMars mission, so that both parties still benefit from it.

The second highest priority Flagship mission for the decade 2013-2022 is the Jupiter Europa Orbiter (JEO). However, its cost as currently designed is so high that both a decrease in mission scope and an increase in NASA's planetary budget are necessary to make it affordable. The projected cost of the mission as currently designed is \$4.7 billion FY2015. If JEO were to be funded at this level within the currently projected NASA planetary budget it would lead to an unacceptable programmatic imbalance, eliminating too many other important missions. Therefore, while the committee recommends JEO as the second highest priority Flagship mission, close behind MAX-C, it should fly in the decade 2013-2022 only if changes to both the mission and the NASA planetary budget make it affordable without eliminating any other recommended missions. These changes are likely to involve both a reduction in mission scope and a formal budgetary new start for JEO that is accompanied by an increase in the NASA planetary budget. NASA should immediately undertake an effort to find major cost reductions for JEO, with the goal of minimizing the size of the budget increase necessary to enable the mission.

The third highest priority Flagship mission is the Uranus Orbiter and Probe mission. The committee carefully investigated missions to both ice giants, Uranus and Neptune. While both missions have high scientific merit, the conclusion was that a Uranus mission is favored for the decade 2013-2022 for practical reasons involving available trajectories, flight times, and cost. The Uranus Orbiter and Probe mission should be initiated in the decade 2013-2022 even if both MAX-C and JEO take place. But like those other two missions, it should be subjected to rigorous independent cost verification throughout its development, and descoped or canceled if costs grow significantly above the projected cost of \$2.7 billion FY2015.

Table ES.3 summarizes the recommended large missions and associated decision rules.

Following the priorities and decision rules outlined above, two example programs of solar system exploration can be described for the decade 2013-2022.

The *Recommended Program* can be conducted assuming a budget increase sufficient to allow a new start for JEO. It includes the following elements (in no particular order):

- Discovery program funded at the current level adjusted for inflation;
- Mars Trace Gas Orbiter conducted jointly with ESA;
- New Frontiers Missions 4 and 5;
- MAX-C (descoped to \$2.5 billion);

- Jupiter Europa Orbiter (descoped);
- Uranus Orbiter and Probe

The *Cost Constrained Program* can be conducted assuming the currently projected NASA planetary budget. It includes the following elements (in no particular order):

- Discovery program funded at the current level adjusted for inflation;
- Mars Trace Gas Orbiter conducted jointly with ESA;
- New Frontiers Mission 4 and 5;
- MAX-C (descoped to \$2.5 billion);
- Uranus Orbiter and Probe

Plausible circumstances could improve the budget picture presented above. If this happened, the additions to the recommended plan should be, in priority order:

1. An increase in funding for the Discovery program,
2. Another New Frontiers mission, and
3. Either the Enceladus Orbiter mission or the Venus Climate Mission.

It is also possible that the budget picture could be less favorable than the committee has assumed. If cuts to the program are necessary, the first approach should be descoping or delaying Flagship missions. Changes to the New Frontiers or Discovery programs should be considered only if adjustments to Flagship missions cannot solve the problem. And high priority should be placed on preserving funding for research and analysis programs and for technology development.

Looking ahead to possible missions in the decade beyond 2022, it is important to make significant near-term technology investments in the Mars Sample Return Lander, Mars Sample Return Orbiter, Titan Saturn System Mission, and Neptune System Orbiter and Probe.

NASA-FUNDED SUPPORTING RESEARCH AND TECHNOLOGY DEVELOPMENT

NASA's planetary research and analysis programs are heavily oversubscribed. Consistent with the mission recommendations and costs presented above, the committee recommends that NASA increase the research and analysis budget for planetary science by 5 percent above the total finally approved FY2011 expenditures in the first year of the coming decade, and increase the budget by 1.5 percent above the inflation level for each successive year of the decade. Also, the future of planetary science depends on a well-conceived, robust, stable technology investment program. The committee unequivocally recommends that a substantial program of planetary exploration technology development should be reconstituted and carefully protected against all incursions that would deplete its resources. This program should be consistently funded at approximately 6 to 8 percent of the total NASA Planetary Science Division budget.

NSF-FUNDED RESEARCH AND INFRASTRUCTURE

The National Science Foundation supports nearly all areas of planetary science except space missions, which it supports indirectly through laboratory research and archived data. NSF grants and support for field activities are an important source of support for planetary science in the United States, and should continue. NSF is also the largest federal funding agency for ground-based astronomy in the United States. The ground-based observational facilities supported wholly or in part by NSF are essential to planetary astronomical observations, both in support of active space missions and in studies

PREPUBLICATION COPY—SUBJECT TO FURTHER EDITORIAL CORRECTION

ES-5

independent of (or as follow up to) such missions. Their continued support is critical to the advancement of planetary science.

One of the future NSF-funded facilities most important to planetary science is the Large Synoptic Survey Telescope (LSST). The committee encourages the timely completion of LSST, and stresses the importance of its contributions to planetary science once telescope operations begin. Finally, the committee recommends expansion of NSF funding for the support of planetary science in existing laboratories, and the establishment of new laboratories as needs develop.

TABLE ES.1 Medium Class Missions—New Frontiers 4 (in alphabetical order)

Mission Recommendation	Scientific Objectives	Key Challenges	Decision Rules	Chapter
Comet Surface Sample Return	<ul style="list-style-type: none"> Acquire and return to Earth for laboratory analysis a macroscopic (≥ 500 cc) comet nucleus surface sample Characterize the surface region sampled Preserve sample complex organics 	<ul style="list-style-type: none"> Sample acquisition Mission design System mass 	N/A	4
Lunar South Pole-Aitken Basin Sample Return	Same as 2002 decadal survey	N/A	Remove if MoonRise is selected for NF-3	5
Saturn Probe	<ul style="list-style-type: none"> Determine noble gas abundances and isotopic ratios of hydrogen, carbon, nitrogen, and oxygen in Saturn's atmosphere Determine the atmospheric structure at the probe descent location 	<ul style="list-style-type: none"> Entry probe Payload requirements growth 	N/A	7
Trojan Tour and Rendezvous	Visit, observe, and characterize multiple Trojan asteroids	<ul style="list-style-type: none"> System power System mass 	N/A	4
Venus In Situ Explorer	Same as 2002 decadal survey (and amended by 2007 NRC New Frontiers report)	N/A	Remove if SAGE is selected for NF-3	5

NOTE: N/A = Not available (not evaluated by decadal survey). The MoonRise and SAGE missions that address these scientific objectives are currently in competition for New Frontiers 3 (NF-3).

TABLE ES.2 Medium Class Missions—New Frontiers 5 (in alphabetical order)

Mission Recommendation	Scientific Objectives	Key Challenges	Decision Rules	Chapter
Comet Surface Sample Return	See Table ES.1	See Table ES.1	Remove if selected for NF-4	4
Io Observer	Determine internal structure of Io and mechanisms contributing to Io's volcanism	<ul style="list-style-type: none"> • Radiation • System power 	Remove if selected for NF-4	8
Lunar Geophysical Network	Enhance knowledge of lunar interior	<ul style="list-style-type: none"> • Propulsion • Mass • Reliability • Mission operations 	Remove if selected for NF-4	5
Lunar South Pole-Aitken Basin Sample Return	See Table ES.1	N/A	Remove if selected for NF-4, or if MoonRise is selected for NF-3	5
Saturn Probe	See Table ES.1	See Table ES.1	Remove if selected for NF-4	7
Trojan Tour and Rendezvous	See Table ES.1	See Table ES.1	Remove if selected for NF-4	4
Venus In Situ Explorer	See Table ES.1	N/A	Remove if selected for NF-4, or if SAGE is selected for NF-3	5

NOTE: N/A = Not available (not evaluated by decadal survey). The MoonRise and SAGE missions that address these scientific objectives are currently in competition for New Frontiers 3.

TABLE ES.3 Large Class Missions (in priority order)

Mission Recommendation	Scientific Objectives	Key Challenges	Decision Rules	Chapter
Mars Astrobiology Explorer-Cacher Descope	<ul style="list-style-type: none"> • Perform in situ science on Mars samples to look for evidence of ancient life or pre-biotic chemistry • Collect, document, and package samples for future collection and return to Earth 	<ul style="list-style-type: none"> • Keeping within Mars Science Laboratory design constraints • Sample handling, encapsulation, and containerization • Increased rover traverse speed over MSL and MER 	Should be flown only if it can be conducted for a cost to NASA of no more than approximately \$2.5 billion (FY '15 dollars)	6
Jupiter Europa Orbiter Descope	Explore Europa to investigate its habitability	<ul style="list-style-type: none"> • Radiation • Mass • Power • Instruments 	Should be flown only if changes to both the mission design and the NASA planetary budget make it affordable without eliminating any other recommended missions.	8
Uranus Orbiter and Probe (no Solar Electric Propulsion stage)	<ul style="list-style-type: none"> • Investigate the interior structure, atmosphere, and composition of Uranus • Observe the Uranus satellite and ring systems 	<ul style="list-style-type: none"> • Demanding entry probe mission • Long life (15.4 years) for orbiter • High magnetic cleanliness for orbiter • System mass and power 	Should be initiated even if both MAX-C and JEO take place.	7

Summary

This report was requested by the National Aeronautics and Space Administration (NASA) and the National Science Foundation (NSF) to review and assess the current status of planetary science and to develop a comprehensive science and mission strategy that updates and extends the National Research Council's (NRC's) 2002 planetary decadal survey, *New Frontiers in the Solar System: An Integrated Exploration Strategy*.¹ As is standard for a decadal survey, the Committee on the Planetary Science Decadal Survey that was established to write this report broadly canvassed the planetary science community to determine the current state of knowledge and to identify the most important scientific questions to be addressed during the period 2013-2022. The ground- and space-based programmatic initiatives needed to address these important questions are identified, assessed, and prioritized. The committee also addressed relevant programmatic and implementation issues of interest to NASA and NSF.

SCOPE OF THIS REPORT

The scope of this report spans the scientific disciplines that collectively encompass the ground- and space-based elements of planetary science. It also covers the physical territory within the committee's purview; the solar system's principal constituents. This territory includes the following:

- The major rocky bodies in the inner solar system;
- The giant planets in the outer solar system;
- The satellites of the giant planets; and
- Primitive solar system bodies.

The committee imposed programmatic boundary conditions, largely derived from its statement of task, to ensure that this report contains actionable advice:

- The principal findings and recommendations contained in *New Frontiers in the Solar System* and more recent NRC reports relevant to planetary science activities were assessed, and incorporated where appropriate. Missions identified in those past reports were reprioritized if they had not yet been confirmed for implementation.
 - Priorities for spacecraft missions to the Moon, Mars, and other solar system bodies were treated in a unified manner with no predetermined “set asides” for specific bodies. This differs distinctly from the ground rules for the 2003 planetary decadal survey, where missions to Mars were prioritized separately.
 - The committee's programmatic recommendations were designed to be achievable within the boundaries of anticipated NASA and NSF funding.
 - The report is cognizant of the current statutory roles of NSF and NASA, and how these roles may or may not be consistent with current practices within these agencies regarding support for specific activities—e.g., the funding mechanisms, construction, and operation of ground-based observatories.

PREPUBLICATION COPY—SUBJECT TO FURTHER EDITORIAL CORRECTION

S-1

- The report reflects an awareness of the science and space mission plans and priorities of potential foreign and U.S. agency partners. This report's recommendations are, however, addressed to NASA and NSF.

To maintain consistency with other advice developed by the NRC and to ensure that this report clearly addresses those topics identified in the committee's statement of task, the following topics were not addressed in this report.

- Issues relating to the hazards posed by near-Earth objects and approaches to hazard mitigation. However, scientific studies of near-Earth asteroids are discussed in this report.
- Study of the Earth system, including its atmosphere, magnetosphere, surface, and interior.
- Studies of solar and heliospheric phenomena, with the exception of interactions with the atmospheres, magnetospheres, and surfaces of solar system bodies; and magnetospheric effects of planets on their satellites and rings.
- Ground- and space-based studies to detect and characterize extrasolar planets. This report does contain, however, a discussion of the scientific issues concerning the comparative planetology of the solar system's planets and extrasolar planets; together with issues related to the formation and evolution of planetary system.

The committee's statement of task calls for this report to contain three principal elements: a survey of planetary science; an assessment of and recommendations relating to NASA activities, and an assessment of and recommendations relating to NSF activities. Subsequent sections of this summary address each of these topics in turn.

SURVEY OF PLANETARY SCIENCE

Overview of Planetary Science

Planetary science is shorthand for the broad array of scientific disciplines that collectively seek answers to basic questions such as how do planets form, how do they work, and why is at least one planet the abode of life. These basic motivations explain why planetary science is an important undertaking, worthy of public support. Though deceptively simple, they have spawned a 50-year epic series of exploratory voyages by robotic spacecraft that have visited almost every type of planetary body in humankind's celestial neighborhood. These robotic voyages have been complemented by investigations with ground- and space-based telescopes, laboratory studies, theoretical studies, and modeling activities. The resulting grand adventure has transformed humankind's understanding of the collection of objects orbiting the Sun. Mission after mission, study after study, have uncovered stunning new discoveries. Since *New Frontiers* was published in 2003, ground and space-based planetary science activities have been particularly productive. Some particularly notable examples of recent advances include the following:

- An explosion in the number of known exoplanets;
- The Moon is less dry than once thought;
- Minerals that must have formed in a diverse set of aqueous environments throughout martian history;
- Extensive deposits of near-surface ice on Mars;
- An active meteorological cycle involving liquid methane on Titan;
- Variability of the giant planets;

PREPUBLICATION COPY—SUBJECT TO FURTHER EDITORIAL CORRECTION

S-2

- Recent volcanic activity on Venus;
- Geothermal and plume activity at the south pole of Enceladus;
- The anomalous isotopic composition of the planets;
- The unexpected nature of comet dust;
- Mercury's liquid core; and
- The richness and diversity of the Kuiper belt.

Current State of Knowledge and Important Scientific Questions

The deep-rooted motives underlying the planetary sciences address issues of profound importance that have been pondered by scientists and non-scientists alike for centuries. They cannot be fully addressed by a single spacecraft mission or series of telescopic observations. Rather they will likely not be completely addressed in this decade or the next. To make progress in organizing and outlining the current state of knowledge, the committee translates and codifies the basic motivations for planetary science into three broad, crosscutting themes:

- *Building new worlds*—understanding solar system beginnings,
- *Planetary habitats*—searching for the requirements for life, and
- *Workings of solar systems*—revealing planetary processes through time.

Each theme brings its own set of questions, based on current understanding of the underlying scientific issues:

- *Building new worlds*
 - What were the initial stages, conditions and processes of solar system formation and the nature of the interstellar matter that was incorporated? Important objects for study: comets, asteroids, Trojans, and Kuiper belt objects.
 - How did the giant planets and their satellite systems accrete, and is there evidence that they migrated to new orbital positions? Important objects for study: Enceladus, Europa, Io, Ganymede, Jupiter, Saturn, Uranus, Neptune, Kuiper belt objects, Titan, and rings.
 - What governed the accretion, supply of water, chemistry, and internal differentiation of the inner planets and the evolution of their atmospheres, and what roles did bombardment by large projectiles play? Important objects for study: Mars, the Moon, Trojans, Venus, asteroids, and comets.
- *Planetary habitats*
 - What were the primordial sources of organic matter, and where does organic synthesis continue today? Important objects for study: comets, asteroids, Trojans, Kuiper belt objects, Enceladus, Europa, Mars, and Titan and uranian satellites.
 - Did Mars or Venus host ancient aqueous environments conducive to early life, and is there evidence that life emerged? Important objects for study: Mars and Venus.
 - Beyond Earth, are there contemporary habitats elsewhere in the solar system with necessary conditions, organic matter, water, energy, and nutrients to sustain life, and do organisms live there now? Important objects for study: Enceladus, Europa, Mars, and Titan.
- *Workings of solar systems*
 - How do the giant planets serve as laboratories to understand Earth, the solar system, and extrasolar planetary systems? Important objects for study: Jupiter, Neptune, Saturn, and Uranus.
 - What solar system bodies endanger and what mechanisms shield Earth's biosphere? Important objects for study: near-Earth objects, the Moon, comets, and Jupiter.

PREPUBLICATION COPY—SUBJECT TO FURTHER EDITORIAL CORRECTION

—Can understanding the roles of physics, chemistry, geology, and dynamics in driving planetary atmospheres and climates lead to a better understanding of climate change on Earth? Important objects for study: Mars, Jupiter, Neptune, Saturn, Titan, Uranus, and Venus.

—How have the myriad chemical and physical processes that shaped the solar system operated, interacted, and evolved over time? Important objects for study: all planetary bodies.

Each question represents a distillation of major areas of research in planetary science and the questions themselves are sometimes crosscutting. Each question points to one or more solar system bodies that may hold clues or other vital information necessary for their resolution. The detailed discussions in Chapters 4 to 8 further explore these questions, dissecting them to identify the specific opportunities best addressed in the coming decade by large, medium, and small spacecraft missions, as well as by other space- and ground-based research activities.

NASA ACTIVITIES

The principal support for research related to solar system bodies in the United States comes from the Planetary Science Division (PSD) of NASA's Science Mission Directorate. PSD does this via a combination of spacecraft missions, technology development activities, support for research infrastructure, and research grants. The annual budget of PSD is currently approximately \$1.3 billion. The bulk of this is spent on the development, construction, launch, and operation of spacecraft. Two types of spacecraft missions are conducted: large "Flagship" missions strategically directed by the PSD and smaller Discovery and New Frontiers missions proposed and led by principal investigators (PIs). The choice and scope of strategic missions is determined through a well-developed planning process, drawing its scientific inputs from advisory groups both internal and external (NRC) to NASA. The PI-led missions are selected by a peer-reviewed process that considers the scientific, technical, and fiscal merit of competing proposals submitted in open competition.

The statement of task for this study called for creation of a prioritized list of flight investigations for the decade 2013-2022. A prioritized list implies that the elements of the list have been judged and ordered with respect to a set of appropriate criteria. Four criteria were used. The first and most important was science return per dollar. Science return was judged with respect to the key scientific questions described above; costs were estimated via a procedure described below. The second was programmatic balance—striving to achieve an appropriate balance among mission targets across the solar system and an appropriate mix of small, medium, and large missions. The other two criteria were technological readiness and availability of trajectory opportunities within the 2013-2022 time period.

The recommended flight projects for the coming decade were considered within the context of the broader program of planetary exploration. All of the mission recommendations that follow assume the following activities are fully funded:

- Continue missions currently in flight, subject to approval via the appropriate senior review process. Ensure a level of funding that is adequate for successful operation, analysis of data, and publication of the results of these missions, and for extended missions that afford rich new science return.
- Continue missions currently in development.
- Increase funding for fundamental research and analysis grant programs, beginning with a 5 percent increase above the total finally approved fiscal year (FY) 2011 expenditures and then growing at an additional 1.5 percent per year above inflation for the remainder of the decade.
- Establish and maintain a significant and steady level of funding (6 to 8 percent of the planetary exploration budget) for development of technologies that will enable future planetary flight projects.

Mission Study Process and Technical Evaluation

In order to help develop recommendations, the committee commissioned technical studies of many candidate missions. These candidate missions were selected for study on the basis of white papers submitted by the scientific community (Appendix B provides a list of all white papers submitted).

A subset of the mission studies was selected by the committee for further analysis using the cost appraisal and technical evaluation (CATE) process, which was performed by the Aerospace Corporation, a contractor to the NRC. This selection was made on the basis of the four prioritization criteria listed above, with science return per dollar being the most important. The CATE process was designed to provide an independent assessment of the technical feasibility of the mission candidates, as well as to produce a rough appraisal of their costs. The process takes into account many factors when evaluating a mission's potential costs, including the actual costs of analogous previous missions.

The CATE process typically resulted in cost estimates that were significantly higher than the estimates produced by the teams that conducted the studies. The primary reason for this is that basing cost estimates on the actual costs of analogous part projects avoids the inherent optimism of other cost estimation processes. Only the independently generated cost estimates were used in evaluation of the candidate missions by the committee in formulating the final recommendations. This approach is intentionally cautious, and was designed to help avoid the unrealistic cost estimates and consequent replanning that has sometimes characterized the planetary program in the past.

It should be stressed that the studies carried out were of specific “point designs” for the mission candidates that were identified by the survey's panels. These point designs are a “proof of concept” that such a mission may be feasible, and provide a basis for developing a cost estimate for the purpose of the decadal survey. The actual missions as flown may differ in their detailed designs and their final costs from what was studied, but **in order to maintain a balanced and orderly program, their final costs must not be allowed to grow significantly beyond those estimated here.**

Achieving a Balanced Program

In addition to maximizing science return per dollar, another important factor in formulating the committee's recommendations was achieving programmatic balance. The challenge is to assemble a portfolio of missions that achieves a regular tempo of solar system exploration and a level of investigation appropriate for each target object. For example, a program consisting of only Flagship missions once per decade may result in long stretches of relatively little new data being generated, leading to a stagnant community. Conversely, a portfolio of only Discovery-class missions would be incapable of addressing important scientific challenges like in-depth exploration of the outer planets. **NASA's suite of planetary missions for the decade 2013-2022 should consist of a balanced mix of Discovery, New Frontiers, and Flagship missions, enabling both a steady stream of new discoveries and the capability to address larger challenges like sample return missions and outer planet exploration.** The program recommended below was designed to achieve such a balance. In order to prevent the balance among mission classes from becoming skewed, it is crucial that all missions, particularly the most costly ones, be initiated with a good understanding of their probable costs. The CATE process was specifically designed to address this issue by taking a realistic approach to cost estimation.

It is also important for there to be an appropriate balance among the many potential targets in the solar system. Achieving this balance was one of the key factors that went into the recommendations for medium and large missions presented below. The committee notes, however, that there should be no entitlement in a publicly funded program of scientific exploration. Achieving balance must not be used as an excuse for not making difficult but necessary choices.

The issues of balance across the solar system and balance among mission sizes are related. For example, it is difficult to investigate targets in the outer solar system with small or even medium missions. On the other hand, some targets are ideally suited to small missions. The committee's

recommendations below bear this fact in mind, and implicitly assume that Discovery missions will address important questions that do not require medium or large missions in order to be addressed.

It is not appropriate to achieve balance simply by allocating certain numbers or certain sizes of missions to certain classes of objects. Instead, **the appropriate balance across the solar system must be found by selecting the set of missions that best addresses the highest priorities among the overarching scientific questions above.** The recommendations below are made in accordance with this principle.

Recommended Program of Missions

Small Missions

Within the category of small missions, there are three elements of particular interest: the Discovery program, extended missions for ongoing projects, and Missions of Opportunity.

Discovery Program

Mission candidates for the Discovery program are outside the bounds of a decadal strategic plan, and this decadal survey makes no specific Discovery flight mission recommendations. The committee stresses, however, that **the Discovery program has made important and fundamental contributions to planetary exploration, and can continue to do so in the coming decade.** The committee gives it its strong support.

We note that NASA does not intend to continue the Mars Scout program beyond the MAVEN mission, nor do we recommend that they do so. Instead, **the committee recommends that NASA continue to allow Discovery missions to be proposed to all planetary bodies, including Mars.**

Because there is still so much compelling science that can be addressed by Discovery missions, **the committee recommends continuation of the Discovery program at its current level, adjusted for inflation, with a cost cap per mission that is also adjusted for inflation from the current value (i.e., to about \$500 million FY2015).** In order for the community to plan Discovery missions effectively, **the committee recommends a regular, predictable, and preferably short (≤ 24 month) cadence for Discovery Announcement of Opportunity (AO) releases and mission selections.** Because so many important missions can be flown within the current Discovery cost cap (adjusted for inflation), the committee views a steady tempo of Discovery AOs and selections to be more important than increasing the cost cap, as long as launch vehicle costs continue to be excluded. A hallmark of the Discovery program has been rapid and frequent mission opportunities. The committee urges NASA to assess schedule risks carefully during mission selection, and to plan program budgeting so as to maintain the original goals of the Discovery program.

Other Small Mission Opportunities

Mission extensions can be significant and highly productive, and may also enhance missions that undergo changes in scope due to unpredictable events. In some cases, particularly the “re-purposing” of operating spacecraft, fundamentally new science can be enabled. These mission extensions, which require their own funding arrangements, can be treated as independent, small-class missions. The committee supports NASA’s current senior review process for deciding the scientific merits of a proposed mission extension. **The committee recommends that early planning be done to provide adequate funding of mission extensions, particularly for Flagship missions and missions with international partners.**

Near the end of the past decade, NASA introduced a new acquisition vehicle called Stand Alone Missions of Opportunity (SALMON). In addition to their science return, Missions of Opportunity provide a chance for new entrants to join the field, for technologies to be validated, and for future PIs to gain experience. **The committee welcomes the introduction of this highly flexible SALMON approach, and recommends that it be used wherever possible to facilitate Mission of Opportunity collaborations.**

An important special case of a small mission is the proposed joint European Space Agency (ESA)/NASA Mars Trace Gas Orbiter. The mission would launch in 2016, with NASA providing the launch vehicle, ESA providing the orbiter, and a joint science payload that was recently selected. Based on its high science value and its relatively low cost to NASA, **the committee supports flight of the Mars Trace Gas Orbiter in 2016 as long as this division of responsibilities with ESA is preserved.**

Medium Missions

The New Frontiers program allows for competitive selection of focused, strategic missions to conduct high-quality science. The current New Frontiers cost cap, inflated to FY2015 dollars, is \$1.05 billion, including launch vehicle costs. **The committee recommends changing the New Frontiers cost cap to \$1.0 billion FY2015, excluding launch vehicle costs.** This change represents a modest increase in the total cost of a New Frontiers mission provided that the cost of launch vehicles does not rise precipitously; the increase is fully accounted for in the program recommendations below. This change will allow a scientifically rich and diverse set of New Frontiers missions to be carried out. Importantly, it will also help protect the science content of the New Frontiers program against increases and volatility in launch vehicle costs.

The New Frontiers program to date has resulted in the selection of the New Horizons mission to Pluto and the Juno mission to Jupiter. The former is in flight and the latter is in development. A competition to select a third New Frontiers mission is now underway, with selection scheduled for 2011. In this report the committee addresses subsequent New Frontiers missions, beginning with the fourth, to be selected during the decade 2013-2022.

Based on their science value and projected costs, the committee has identified seven candidate New Frontiers missions for the decade 2013-2022. All are judged to be plausibly achievable within the recommended New Frontiers cost cap (although, for some, not within the previous cap). In alphabetical order, they are:

- *Comet Surface Sample Return*—The objective of this mission is to acquire and return to Earth a macroscopic sample from the surface of a comet nucleus using a sampling technique that preserves organic material in the sample.
- *Io Observer*—The focus of this mission is to determine the internal structure of Io and to investigate the mechanisms that contribute to the satellite's intense volcanic activity from a highly elliptical orbit around Jupiter, making multiple flybys of Io.
- *Lunar Geophysical Network*—This mission consists of several identical landers distributed across the lunar surface, each carrying geophysical instrumentation. The primary science objectives are to characterize the Moon's internal structure, seismic activity, global heat flow budget, bulk composition, and magnetic field.
- *Lunar South Pole-Aitken Basin Sample Return*—The primary science objective of this mission is to return samples from this ancient and deeply excavated impact basin to Earth for characterization and study.
- *Saturn Probe*—This mission would deploy a probe into Saturn's atmosphere to determine the structure of the atmosphere as well as noble gas abundances and isotopic ratios of hydrogen, carbon, nitrogen, and oxygen.

PREPUBLICATION COPY—SUBJECT TO FURTHER EDITORIAL CORRECTION

S-7

- *Trojan Tour and Rendezvous*—This mission is designed to examine two or more small bodies sharing the orbit of Jupiter, including one or more flybys followed by an extended rendezvous with a Trojan object.
- *Venus In Situ Explorer*—The primary science objectives of this mission are to examine the physics and chemistry of Venus’s atmosphere and crust. The mission attempts to characterize variables that cannot be measured from orbit, including the detailed composition of the lower atmosphere, and the elemental and mineralogical composition of surface materials.

The current competition to select the third New Frontiers mission includes the SAGE mission to Venus and the MoonRise mission to the Moon. These missions are responsive to the science objectives of the Venus In Situ Explorer and the Lunar South Pole-Aitken Basin Sample Return, respectively. We assume that the ongoing NASA evaluation of these two missions has validated their ability to be performed at a cost appropriate for New Frontiers. For the other five listed above, the cost appraisal and technical evaluations performed in support of this decadal survey show that it may be possible to execute them within the New Frontiers cap.

In order to achieve an appropriate balance among small, medium, and large missions, NASA should select two New Frontiers missions in the decade 2013-2022. These are referred to here as New Frontiers Mission 4 and New Frontiers Mission 5.

New Frontiers Mission 4 should be selected from among the following five candidates:

- **Comet Surface Sample Return,**
- **Lunar South Pole-Aitken Basin Sample Return,**
- **Saturn Probe,**
- **Trojan Tour and Rendezvous, and**
- **Venus In Situ Explorer.**

These five missions were selected from the seven listed above based on the criteria of science return per dollar, programmatic balance, technological readiness, and availability of spacecraft trajectories. No relative priorities are assigned to these five mission candidates; instead, the selection among them should be made on the basis of competitive peer review.

If either SAGE or MoonRise is selected by NASA in 2011 as the third New Frontiers mission, the corresponding mission candidate should be removed from the above list of five, reducing the number of candidates from which NASA should make the New Frontiers Mission 4 selection to four.

For the New Frontiers Mission 5 selection, the Io Observer and the Lunar Geophysical Network should be added to the list of remaining candidate missions, increasing the total number of candidates for that selection to either five or six. Again, no relative priorities are assigned to any of these mission candidates.

Large Missions

The decadal survey has identified five candidate Flagship missions for the decade 2013-2022. In alphabetical order, they are:

- *Enceladus Orbiter*—This mission will investigate that saturnian satellite’s cryovolcanic activity, habitability, internal structure, chemistry, geology, and interaction with the other bodies of the Saturn system.
- *Jupiter Europa Orbiter (JEO)* —This mission will characterization of Europa’s ocean and interior, ice shell, chemistry and composition, and the geology of prospective landing sites.

PREPUBLICATION COPY—SUBJECT TO FURTHER EDITORIAL CORRECTION

- *Mars Astrobiology Explorer-Cacher (MAX-C)*—This mission is the first of the three components of a Mars sample return campaign. It is responsible for characterizing a landing site that has been selected for high science potential, and for collecting, documenting, and packaging samples for return to Earth.
- *Uranus Orbiter and Probe*—This mission deploys a small atmospheric probe into Uranus to make in situ measurements of noble gas abundances and isotopic ratios, then enters orbit, making remote sensing measurements of the planet’s atmosphere, interior, magnetic field, and rings, as well as multiple flybys of the larger uranian satellites.
- *Venus Climate Mission*—This mission is designed to address science objectives concerning the Venus atmosphere, including carbon dioxide greenhouse effects, dynamics and variability, surface/atmosphere exchange, and origin. The mission architecture includes a carrier spacecraft, a gondola/balloon system, a mini-probe, and two drop sondes.

The cost appraisal and technical evaluations performed for these five candidate Flagship missions have yielded estimates for the full life-cycle cost of each mission, including the cost of the launch vehicle, in FY2015 dollars. For missions with international components (EJSM and MAX-C) only the NASA costs are included. The cost estimates are as follows:

- Enceladus Orbiter, \$1.9 billion;
- Jupiter Europa Orbiter, \$4.7 billion;
- Mars Astrobiology Explorer-Cacher, \$3.5 billion²;
- Uranus Orbiter and Probe, \$2.7 billion³; and
- Venus Climate Mission, \$2.4 billion.

The committee devoted considerable attention to the relative priorities of the various large-class mission candidates. In particular, both JEO and the Mars Sample Return campaign (beginning with MAX-C) were found to have exceptional science merit. Because it was difficult to discriminate between the Mars Sample Return campaign and JEO on the basis of their anticipated science return per dollar alone, other factors came into play. Foremost among these was the need to maintain programmatic balance by assuring that no one mission takes up too large a fraction of the planetary budget at any given time.

The highest priority Flagship mission for the decade 2013-2022 is MAX-C, which will begin the NASA-ESA Mars Sample Return campaign. However, the cost of MAX-C must be constrained in order to maintain programmatic balance.

The Mars community, in their inputs to the decadal survey, was emphatic in their view that a sample return mission is the logical next step in Mars exploration. Mars science has reached a level of sophistication that fundamental advances in addressing the important questions above will only come from analysis of returned samples. MAX-C will also explore a new site and significantly advance our understanding of the geologic history and evolution of Mars, even before the cached samples are returned to Earth.

Unfortunately, at an independently estimated cost of \$3.5 billion, MAX-C would take up a disproportionate near-term share of the overall budget for NASA’s Planetary Science Division. This very high cost results in large part from two large and capable rovers—both a NASA sample-caching rover and the ESA’s ExoMars rover—being jointly delivered by a single entry, descent, and landing (EDL) system that is derived from the Mars Science Laboratory (MSL) EDL system. The CATE results for MAX-C projected that accommodation of two such large rovers would require major redesign of the MSL EDL system, with substantial associated cost growth.

The committee recommends that NASA should fly the MAX-C mission in the decade 2013-2022 only if it can be conducted for a cost to NASA of no more than approximately \$2.5 billion (FY2015 dollars). If a cost of no more than about \$2.5 billion FY2015 cannot be verified, the mission

(and the subsequent elements of Mars Sample Return) should be deferred until a subsequent decade or cancelled outright.

It is likely that a significant reduction in mission scope will be needed to keep the cost of MAX-C below \$2.5 billion. A key part of this reduction in scope is likely to be reducing landed mass and volume. In particular, it is crucial to preserve, as much as possible, both the system structure and the individual elements of MSL's EDL system. A significant reduction in landed mass and volume can be expected to lead to a significant reduction in the scientific capabilities of the vehicles delivered to the surface.

The committee recognizes that MAX-C is envisioned by NASA to be part of a joint NASA-ESA program of Mars exploration that also includes the 2016 Mars Trace Gas Orbiter. **In order to be of benefit to NASA, this partnership must also involve ESA participation in other missions of the three-mission Mars Sample Return campaign.** It is therefore crucial to both parties for the partnership to be preserved. The best way to maintain the partnership will be an equitable reduction in scope of both the NASA and ESA objectives for the MAX-C/ExoMars mission, so that both parties still benefit from it. **The guiding principle for any descope process should be to preserve the highest priority science objectives of the total Mars program for both agencies while reducing costs to acceptable levels.**

The second highest priority Flagship mission for the decade 2013-2022 is JEO. However, its cost as currently designed is so high that both a decrease in mission scope and an increase in NASA's planetary budget are necessary to make it affordable.

The Europa Geophysical Explorer, from which the JEO concept is derived, was the one Flagship mission recommended in the previous planetary decadal survey. The scientific case for this mission was compelling then, and it remains compelling now. Substantial technology work has been done on JEO over the past decade, with the result that NASA is much more capable of accomplishing this mission than was the case 10 years ago.

The difficulty in achieving JEO is its cost. The projected cost of the mission as currently designed is \$4.7 billion FY2015. If JEO were to be funded at this level within the currently projected NASA planetary budget it would lead to an unacceptable programmatic imbalance, eliminating too many other important missions. Therefore, while the committee recommends JEO as the second highest priority Flagship mission, close behind MAX-C, **it should fly in the decade 2013-2022 only if changes to both the mission and the NASA planetary budget make it affordable without eliminating any other recommended missions.** These changes are likely to involve both a reduction in mission scope and a formal budgetary new start for JEO that is accompanied by an increase in the NASA planetary budget.

It is clearly crucial to keep the budget increase required to enable JEO as small as possible. Possible pathways to lower cost include use of a larger launch vehicle that would reduce cost risk by shortening and simplifying the mission design, and a significant reduction in the science payload. **NASA should immediately undertake an effort to find major cost reductions for JEO, with the goal of minimizing the size of the budget increase necessary to enable the mission.**

The third highest priority Flagship mission is the Uranus Orbiter and Probe mission. Galileo, Cassini, and Juno have performed or will perform spectacular in-depth investigations of Jupiter and Saturn. The Kepler mission and microlensing surveys have shown that many exoplanets are ice-giant sized. Exploration of the ice giants Uranus and Neptune is therefore the obvious and important next step in the exploration of the giant planets.

The committee carefully investigated missions to both Uranus and Neptune. While both missions have high scientific merit, the conclusion was that a Uranus mission is favored for the decade 2013-2022 for practical reasons. These reasons include the lack of optimal trajectories to Neptune in that time period, long flight times incompatible with the use of Advanced Stirling Radioisotope Generators for spacecraft power, the risks associated with aerocapture at Neptune, and the high cost of delivery to Neptune. Because of its outstanding scientific potential and a projected cost that is well matched to its anticipated science return, **the Uranus Orbiter and Probe mission should be initiated in the decade 2013-2022 even if both MAX-C and JEO take place.** But like those other two missions, the Uranus Orbiter and Probe should be subjected to rigorous independent cost verification throughout its

development, and descope or canceled if costs grow significantly above the projected \$2.7 billion FY2015.

The fourth and fifth highest priority Flagship missions are, in alphabetical order, the Enceladus Orbiter and the Venus Climate Mission. In order to maintain an appropriate balance among small, medium, and large missions, **these missions should be considered for the decade 2013-2022 only if higher priority missions above cannot be flown for unanticipated reasons, or if additional funding makes them possible.** No relative priority is assigned to these two missions; rather, any choice between them should be made on the basis of programmatic balance. In particular, because of the broad similarity of its science goals to those of JEO, NASA should consider flying the Enceladus Orbiter in the decade 2013-2022 only if JEO is not carried out in that decade.

As stressed several times, the costs of the recommended Flagship missions must not be allowed to grow above the values quoted in this report. Central to accomplishing this is avoiding “requirements creep.” The CATE process does not account for a lack of discipline that allows a mission to become too ambitious. In order to preserve programmatic balance, then, **the scope of each of the recommended Flagship missions cannot be permitted to increase significantly beyond what was assumed during the committee’s cost estimation process.**

Following the priorities and decision rules outlined above, two example programs of solar system exploration can be described for the decade 2013-2022. Both assume continued support of all ongoing flight projects, a research and analysis grant program with a 5 percent increase and further growth at 1.5 percent per year above inflation, and \$100 million FY2015 annually for technology development.

The *Recommended Program* can be conducted assuming a budget increase sufficient to allow a new start for JEO. It includes the following elements (in no particular order):

- Discovery program funded at the current level adjusted for inflation;
- Mars Trace Gas Orbiter conducted jointly with ESA;
- New Frontiers Missions 4 and 5;
- MAX-C at \$2.5 billion;
- Jupiter Europa Orbiter; and
- Uranus Orbiter and Probe.

The *Cost Constrained Program* can be conducted assuming the currently projected NASA planetary budget. It includes the following elements (in no particular order):

- Discovery program funded at the current level adjusted for inflation;
- Mars Trace Gas Orbiter conducted jointly with ESA;
- New Frontiers Mission 4 and 5;
- MAX-C at \$2.5 billion; and
- Uranus Orbiter and Probe.

Table S.1 shows how the recommended program is tied to the crosscutting science themes identified above.

TABLE S.1 Crosscutting Themes, Key Questions and the Missions in the Recommended Plan That Address Them

Crosscutting Theme	Priority Questions	Missions
Building New Worlds	1. What were the initial stages and conditions and processes of solar system formation and the nature of the interstellar matter that was incorporated?	CSSR, Trojan Tour and Rendezvous, Discovery missions
	2. How did the giant planets and their satellite systems accrete, and is there evidence that they migrated to new orbital positions?	JEO, Uranus Orbiter and Probe, Trojan Tour and Rendezvous, Io Observer, Saturn Probe, Enceladus Orbiter
	3. What governed the accretion, supply of water, chemistry, and internal differentiation of the inner planets and the evolution of their atmospheres, and what roles did bombardment by large projectiles play?	Mars Sample Return, Venus In Situ Explorer, Lunar Geophysical Network, Lunar South Pole-Aitken Basin Sample Return, Trojan Tour and Rendezvous, CSSR, Venus Climate Mission, Discovery missions
Planetary Habitats	4. What were the primordial sources of organic matter, and where does organic synthesis continue today?	Mars Sample Return, JEO, Uranus Orbiter and Probe, Trojan Tour and Rendezvous, CSSR, Enceladus Orbiter, Discovery missions
	5. Did Mars or Venus host ancient aqueous environments conducive to early life, and is there evidence that life emerged?	Mars Sample Return, Venus In Situ Explorer, Venus Climate Mission, Discovery missions
	6. Beyond Earth, are there modern habitats elsewhere in the solar system with necessary conditions, organic matter, water, energy, and nutrients to sustain life, and do organisms live there now?	Mars Sample Return, JEO, Enceladus Orbiter, Discovery missions
Workings of Solar Systems	7. How do the giant planets serve as laboratories to understand the Earth, the solar system, and extrasolar planetary systems?	JEO, Uranus Orbiter and Probe, Saturn Probe
	8. What solar system bodies endanger and what mechanisms shield the Earth's biosphere?	CSSR, Discovery missions
	9. Can understanding the roles of physics, chemistry, geology, and dynamics in driving planetary atmospheres and climates lead to a better understanding of climate change on Earth?	Mars Sample Return, JEO, Uranus Orbiter and Probe, Venus In Situ Explorer, Saturn Probe, Venus Climate Mission, Discovery missions
	10. How have the myriad chemical and physical processes that shaped the solar system operated, interacted, and evolved over time?	All recommended missions

Plausible circumstances could improve the picture presented above. If the mission costs presented above are overestimates, the budget increase required for the recommended program would be correspondingly smaller. Increased funding for planetary exploration could make even more missions possible. **If this happened, the committee’s recommended additions to the plans presented above would be, in priority order:**

- 1. An increase in funding for the Discovery program,**
- 2. Another New Frontiers mission, and**
- 3. Either the Enceladus Orbiter or the Venus Climate Mission.**

It is also possible that the budget picture could turn out to be less favorable than the committee has assumed. This could happen, for example, if the actual budget for solar system exploration is smaller than the projections the committee used. **If cuts to the program are necessary, the committee recommends that the first approach should be descoping or delaying Flagship missions. Changes to the New Frontiers or Discovery programs should be considered only if adjustments to Flagship missions cannot solve the problem. And high priority should be placed on preserving funding for research and analysis programs and for technology development.**

Deferred High-Priority Missions

The committee identified a number of additional large missions that are of high scientific value but that are not recommended for the decade 2013-2022 for a variety of reasons. In alphabetical order, these missions are:

- Ganymede Orbiter,
- Mars Sample Return Lander,
- Mars Sample Return Orbiter,
- Mars Geophysical Network,
- Titan Saturn System Mission, and
- Neptune Orbiter and Probe.

While these missions are deferred, technology investments must be made in the decade 2013-2022 to enable them and reduce their costs and risk. In particular, **it is important to make significant technology investments in the Mars Sample Return Lander, Mars Sample Return Orbiter, Titan Saturn System Mission, and Neptune System Orbiter and Probe.**

Launch Vehicle Costs

The costs of launch services pose a challenge to NASA’s program of planetary exploration. Launch costs have risen in recent years for a variety of reasons, and launch costs today tend to be a larger fraction of total mission costs than they were in the past. These increases pose a threat to formulating an effective, balanced planetary exploration program. Possible ways to reduce launch costs include dual manifesting (launching more than one spacecraft on a single vehicle), making block buys of launch vehicles, and exploiting technologies that allow use of smaller, less expensive launch vehicles.

Availability of Plutonium-238

Radioisotope power systems are necessary for powering spacecraft at large distances from the Sun, in the extreme radiation environment of the inner Galilean satellites, in the low light levels of high martian latitudes, dust storms, and night, for extended operations on the surface of Venus, and during the long lunar night. With some 50 years of technology development and use of 46 such systems on 26 previous and currently flying spacecraft, the technology, safe handling, and utility of these units are not in doubt. Of more than 3,000 nuclides, plutonium-238 stands out as the safest and easiest to procure isotope for use on robotic spacecraft.

This report's recommended missions cannot be carried out without new plutonium-238 production or completed deliveries from Russia. There are no technical alternatives to plutonium-238, and the longer the restart of production is delayed, the more it will cost.

The committee is alarmed at the status of plutonium-238 availability for planetary exploration. Without a restart of plutonium-238 production, it will be impossible for the United States, or any other country, to conduct certain important types of planetary missions after this decade.

Supporting Research

Research and Analysis Programs

The research related to planetary missions begins well before a mission is formulated and funded, and continues long after it is over. Research provides both the foundation for interpreting data collected by spacecraft, and the guidance and context for identifying new scientifically compelling missions. Ground-based observations can identify new targets for future missions, and experimental and theoretical results can pose new questions for these missions to answer. Research and analysis programs also allow the maximum possible science return to be harvested from missions. And along with analysis of spacecraft data, the portfolios of research and analysis programs include laboratory experiments, theoretical studies, fieldwork using Earth analogs, planetary geologic mapping, and analysis of data from Earth-based telescopes. All of these fields are crucially important to NASA's long-term science goals, and all require funding.

Current NASA research and analysis funding in most programs supporting planetary research is distributed as multiple small grants. An unfortunate and very inefficient aspect of this policy is that researchers must devote an increasingly large fraction of their time to writing proposals instead of doing science. **The committee strongly encourages NASA to find ways (e.g., by merging related research programs and lengthening award periods) to increase average grant sizes and reduce the number of proposals that must be written, submitted, and reviewed by the community.**

The number of good ideas for planetary research surpasses the funding available to enable that research. More funding for research and analysis would result in more high-quality science being done. However, recommendations for increased research funding must be tempered by the realization that NASA's resources are finite, and that such increases will inevitably cut into funds that are needed to develop new technologies and fly new missions. So an appropriate balance must be sought. After consideration of this balance, and consistent with the mission recommendations and costs presented above, **the committee recommends that NASA increase the research and analysis budget for planetary science by 5 percent above the total finally approved FY2011 expenditures in the first year of the coming decade, and increase the budget by 1.5 percent above the inflation level for each successive year of the decade.**

Data Distribution and Archiving

Data from space missions remain scientifically valuable long after the demise of the spacecraft that provided them, but only if they are archived appropriately in a form readily accessible to the community of users and if the archives are continually maintained for completeness and accuracy. The Planetary Data System (PDS) provides the critical data archiving and distribution function to the planetary science community. Over the past 20 years, the PDS has established a systematic protocol for archiving and distributing mission data that has become the international standard. **It is crucial that the capabilities of the Planetary Data System be maintained by NASA, both to provide a permanent archive of planetary data and to provide a means of distributing those data to the world at large.**

High-level data products must be archived along with the low-level products typically produced by instrument teams. **For future missions, Announcements of Opportunity should mandate that instrument teams propose and be funded to generate derived products before missions have completed Phase E.** In the interim, separate support should be provided for development of high-level data products in cases where such support cannot be provided by mission funding.

Education and Outreach

The tremendous public interest in planets and planetary exploration points to a deeply rooted resonance between the work done by planetary scientists and the broader populace. Such curiosity can lead to a greater appreciation of the role of that science in general and planetary science in particular can play in fostering a vigorous and economically healthy nation. Exploration of the planets is among the most exciting and accessible scientific activities funded by NASA, and indeed by any government agency. NASA's planetary program has a special opportunity, and therefore a special responsibility, to reach out to the public.

Much effort is required to transform raw scientific data into materials of interest to the general public, and such efforts should be directly embedded within each planetary mission. **The committee strongly endorses NASA's informal guideline that a minimum of 1 percent of the cost of each mission be set aside from the project budget for education and public outreach activities.** Modest additional funding must also be set aside to convey to the public the important scientific results from the longer-term supporting research and analysis programs.

Research Infrastructure

The infrastructure supporting NASA's spacecraft missions and related research activities includes ground- and space-based telescopes, the Deep Space Network, and laboratory and sample curation facilities.

NASA Telescope Facilities

Most bodies in the solar system were discovered using telescopes. Utilization of the enormous discovery potential of telescopes is an essential part of our integrated strategy for solar system exploration. Many spacecraft missions, including ones recommended in this report, are designed to follow up on discoveries made using telescopes. Telescopes help identify targets to which spacecraft missions can be flown, and provide ongoing support for spacecraft missions. NASA's Infrared Telescope Facility, for example, is specifically tasked to assist with flight missions, and provides ongoing support for missions such as Cassini, New Horizons, and MESSENGER.

Although most government-supported telescope facilities in the United States are funded by the NSF (see below), NASA continues to play a major role in supporting the use of Earth-based optical and

radar telescopes for planetary studies. **Ground-based facilities that receive NASA support, including the Infrared Telescope Facility, the Keck Observatory, Goldstone, Arecibo, and the Very Long Baseline Array, all make important and in some cases unique contributions to planetary science. NASA should continue to provide support for the planetary observations that take place at these facilities.**

Balloon- and rocket-borne telescopes offer a cost-effective means of studying planetary bodies at wavelengths inaccessible from the ground. Because of their modest costs and development times, they also provide training opportunities for would-be developers of future spacecraft instruments. Although NASA's Science Mission Directorate regularly flies balloon missions into the stratosphere, there are few funding opportunities to take advantage of this resource for planetary science, because typical planetary grants are too small to support these missions. **A funding line to promote further use of these suborbital observing platforms for planetary observations would complement and reduce the load on the already over-subscribed planetary astronomy program.**

The Deep Space Network

The DSN is a critical element of NASA's solar system exploration program. It is the only asset available for communications with missions to the outer solar system, and is heavily subscribed by inner solar system missions as well. As instruments advance and larger data streams are expected over the coming decade, this capability must keep pace with the needs of the mission portfolio. Future demands on the DSN will be substantial. Missions to the distant outer solar system requires access to either 70-meter antennas or equivalent arrays of smaller antennae. The DSN must also be able to receive data from more than one mission at one station simultaneously. If arrays can only mimic the ability of one 70-meter station and nothing more, missions would still be downlink constrained and would have to compete against one another for limited downlink resources.

Although Ka-band downlink has a clear capacity advantage, there is a need to maintain multiple band downlink capability. For example, three-band telemetry during outer planet atmospheric occultations allows sounding of different pressure depths within the atmosphere. In addition, S-band is required for communications from Venus during probe, balloon, lander, and orbit insertion operations where other bands cannot penetrate the atmosphere. X-band capability is required for communication through the atmosphere of Titan, and also for emergency spacecraft communications. **The committee recommends that all three DSN complexes should maintain high power uplink capability in X and Ka-band, and downlink capability in S, Ka, and X-bands. NASA should expand DSN capacities to meet the navigation and communication requirements of missions recommended by this decadal survey, with adequate margins.**

Sample Curation and Laboratory Facilities

Planetary samples are arguably some of the most precious materials on Earth. Just as data returned from planetary spacecraft must be carefully archived and distributed to investigators, samples brought to Earth from space at great cost must be curated and kept uncontaminated and safe for continued study.

Samples to be returned to Earth from many planetary bodies (e.g., the Moon, asteroids, and comets) are given a planetary protection designation of "Unrestricted Earth Return" as they are not regarded as posing any biohazard to Earth. However, future sample-return missions from Mars and other targets that might potentially harbor life (e.g. Europa and Enceladus) are classified as "Restricted Earth Return" and are subject to quarantine restrictions, requiring special receiving and curation facilities. As plans move forward for Restricted Earth Return missions, including Mars sample return, **NASA should establish a single advisory group to provide input on all aspects of collection, containment, characterization and hazard assessment, and allocation of such samples.**

Sample curation facilities are critical components of any sample return mission, and must be designed specifically for the types of returned materials and handling requirements. Early planning and adequate funding are needed so that an adequate facility is available once samples are returned and deemed ready for curation and distribution. **Every sample return mission flown by NASA should explicitly include in the estimate of its cost to the agency the full costs required for appropriate initial sample curation.**

The most important instruments for any sample return mission are the ones in the laboratories on Earth. To derive the full scientific return from sample return missions, it is critical to maintain technical and instrumental capabilities for initial sample characterization, as well as foster expansion to encompass appropriate new analytical instrumentation as it becomes available and as different sample types are acquired. **Well before planetary missions return samples, NASA should establish a well-coordinated and integrated program for development of the next generation of laboratory instruments to be used in sample characterization and analysis.**

Technology Development

The future of planetary science depends on a well-conceived, robust, stable technology investment program. Ongoing missions such as Dawn and the Mars Exploration Rovers underscore the value of past technology investments. Early investment in key technologies reduces the cost risk of complex projects, allowing them to be initiated with reduced uncertainty regarding their eventual total costs. Continued success depends upon strategic investments to enable the future missions that have the greatest potential for discovery. Although this may seem obvious, in recent years investments in new planetary exploration technology have been sharply curtailed and monies originally allocated to it have been used to pay for flight project overruns. Reallocating technology funds to cover tactical exigencies is tantamount to “eating the seed corn.” **The committee unequivocally recommends that a substantial program of planetary exploration technology development should be reconstituted and carefully protected against all incursions that would deplete its resources. This program should be consistently funded at approximately 6 to 8 percent of the total NASA Planetary Science Division budget.** The technology program should be targeted toward the planetary missions that NASA intends to fly, and should be competed wherever possible. This reconstituted technology element should aggregate related but presently uncoordinated NASA technology activities that support planetary exploration, and their tasks should be reprioritized and rebalanced to ensure that they contribute to the mission and science goals expressed in this report.⁴

Technology readiness level (TRL) is a widely used reference system for measuring the development maturity of a particular technology item. In general, low-TRL refers to technologies just beginning to be developed (TRL 1-3), and mid-TRL covers the phases (TRL 4-6) that take an identified technology to a maturity where it is ready to be applied to a flight project. A primary deficiency in past NASA planetary exploration technology programs has been over-emphasis on TRLs 1-3 at the expense of the more costly but vital mid-level efforts necessary to bring the technology to flight readiness. This failure to continue to mature the technologies has resulted in a widespread “Mid-TRL Crisis.” A flight project desiring to use a specific new technology must either complete the development itself, with the concomitant cost and schedule risk, or forgo the capability altogether. To properly complement the flight mission program, therefore, **the committee recommends that the Planetary Science Division’s technology program should accept the responsibility, and assign the required funds, to continue the development of the most important technology items through TRL 6.**

In recent competed mission solicitations, NASA provided incentives for infusion of new technological capabilities in the form of increases to the proposal cost cap. Specific technologies included as incentives were the following:

- Advanced solar electric propulsion, NASA’s Evolutionary Xenon Thruster (NEXT),
- Advanced bipropellant engines, the Advanced Material Bipropellant Rocket (AMBR),
- Aerocapture for orbiters and landers, and
- A new radioisotope power system, the Advanced Stirling Radioisotope Generator (ASRG).

These technologies continue to be of high value to a wide variety of solar system missions. **The committee recommends that NASA should continue to provide incentives for these technologies until they are demonstrated in flight. Moreover, this incentive paradigm should be expanded to include advanced solar power (especially lightweight solar arrays) and optical communications, both of which would be of major benefit for planetary exploration.**

A significant concern with the current planetary exploration technology program is the apparent lack of innovation at the front end of the development pipeline. Truly innovative, breakthrough technologies appear to stand little chance of success in the competition for development money inside NASA, because, by their very nature, they are directed toward far-future objectives rather than specific near-term missions. The committee hopes that the formation of the new NASA Office of the Chief Technologist will elicit an outpouring of innovative technological ideas, and that those concepts will be carefully examined so that the most promising can receive continued support. However, it is not yet clear exactly how future technological responsibilities will be split between the new NASA technology office and the individual mission directorates. Given the unique needs of planetary science, **it is therefore essential that the Planetary Science Division develop its own balanced technology program**, including plans both to encourage innovation and resolve the existing Mid-TRL Crisis.

Although the ingenuity of the nation’s scientists and engineers has made it appear almost routine, solar system exploration still represents one of the most audacious undertakings in human history. Any planetary spacecraft, regardless of its destination, must cope with basically the same set of fundamental operational and environmental challenges. As future mission objectives evolve, meeting these challenges will require advances in the following areas:

- Reduced mass and power requirements for spacecraft and their subsystems;
- Improved communications yielding higher data rates;
- Increased spacecraft autonomy;
- More efficient power and propulsion for all phases of the missions;
- More robust spacecraft for survival in extreme environments;
- New and improved sensors, instruments, and sampling systems; and
- Mission and trajectory design and optimization.

Of all these technologies, none is more critical than high-efficiency power systems for use throughout the solar system. **The committee’s highest priority for near-term multi-mission technology investment is for the completion and validation of the Advanced Stirling Radioisotope Generator.**

For the coming decade, **it is imperative that NASA expand its investment program in all of these fundamental technology areas, with the twin goals of reducing the cost of planetary missions and improving their scientific capability and reliability.** Furthermore, **the committee recommends that NASA expand its program of regular future mission studies to identify as early as possible the technology drivers and common needs for likely future missions.**

In structuring its multi-mission technology investment programs it is important that NASA preserve its focus on fundamental system capabilities rather than solely on individual technology tasks. An example of such an integrated approach, which NASA is already pursuing, is the advancement of solar electric propulsion systems. This integrated approach consists of linked investments in new thrusters, plus new power processing, propellant feed system technology, and the systems engineering expertise that enables these elements to work together. **The committee recommends that NASA**

consider making equivalent systems investments in the advanced Ultraflex solar array technology that will provide higher power at greater efficiency, and aerocapture to enable efficient orbit insertion around bodies with atmospheres.

Discovery and New Frontiers missions would benefit substantially from enhanced technology investments in the multi-mission technology areas described earlier; however, two issues have yet to be overcome:

- The nature of the peer review and selection process effectively precludes reliance on new and “unproven” technology, since it increases the perceived risk and cost of new missions; and
- It is difficult to ensure that proposers have the intimate knowledge of new technologies required to effectively incorporate them into their proposals.

While expanding its investments in generic multi-mission technologies, **NASA should encourage the intelligent use of new technologies in its competed missions. NASA should also put mechanisms in place to ensure that new capabilities are properly transferred to the scientific community for application to competed missions.**

NASA’s comprehensive and costly flagship missions are strategic in nature, and have historically been assigned to NASA centers rather than competed. They can benefit from and in fact are enabled by strategic technology investments.

An obvious candidate for such investments is the Mars Sample Return campaign. MAX-C’s most challenging technology is sample acquisition, processing, and encapsulation on Mars. The two greatest challenges facing the later elements of the campaign are the Mars Ascent Vehicle and the end-to-end planetary protection and sample containment system. **During the decade of 2013-2022, NASA should establish an aggressive, focused technology development and validation initiative to provide the capabilities required to complete the challenging MSR campaign.**

Fortunately, the JEO mission requires no fundamentally new technology in order to accomplish its objectives. However, the capability to design and package the science instruments, especially the detectors, so that can operate successfully in the jovian radiation environment has not yet been completely demonstrated. **A supporting instrument technology program aimed specifically at the issue of acquiring meaningful scientific data in a high radiation environment would be extremely valuable, both for JEO and for any other missions that will explore Jupiter and its moons in the future.**

It is essential that the Planetary Science Division also invest in the technological capabilities that will enable missions in the decade beyond 2022. **The committee strongly recommends that NASA strive to achieve balance in its technology investment programs by addressing both the near-term missions cited specifically in this report, as well as the longer-term missions that will be studied and prioritized in the future.**

The instruments carried by planetary missions provide the data to address key scientific questions and test scientific hypotheses. At present there are significant technological needs across the entire range of instruments, including the improvement and/or adaptation of existing instruments and the development of completely new concepts. Astrobiological exploration in particular is severely limited by a lack of flight ready instruments that can address key questions regarding past or present life elsewhere in the solar system. **The committee recommends that a broad-based, sustained program of science instrument technology development be undertaken, and that this development include new instrument concepts as well as improvements of existing instruments. This instrument technology program should include the funding of development through TRL-6 for those instruments with the highest potential for making new discoveries.**

One of the biggest challenges of solar system exploration is the tremendous variety of environments that spacecraft encounter. Systems or instruments designed for one planetary mission are rarely able to function properly in a different environment. **The committee recommends that, as part of a balanced portfolio, a significant percentage of the Planetary Science Division technology funding**

be set aside for expanding the environmental applicability of existing engineering and science instrument capabilities.

Human Exploration Programs

Human space exploration is undertaken to serve a variety of national and international interests. Human exploration can provide important opportunities to advance science, but science is not the primary motivation. Measurements using remote sensing across the electromagnetic spectrum, atmospheric measurements, or determinations of particle flux density are by far best and most economically conducted using robotic spacecraft. But there is an important subset of planetary exploration that can benefit from human space flight. These are missions to the surfaces of solid bodies whose surface conditions are not too hostile for humans. For the foreseeable future, humans can only realistically explore the surfaces of the Moon, Mars, Phobos and Deimos, and some asteroids.

If the Apollo experience is an applicable guide, robotic missions to targets of interest will undoubtedly precede human missions. Human exploration precursor measurement objectives focus mainly on issues regarding health and safety and engineering practicalities, rather than science.

A positive example of synergy between the human exploration program and science is the current Lunar Reconnaissance Orbiter mission. This project was conceived as a precursor for the human exploration program, but ultimately was executed in concert with the planetary science community. By building on lessons learned from LRO, an effective approach to exploration-driven robotic precursor missions can be constructed.

Despite the positive recent example of LRO, the committee is concerned that human spaceflight programs can cannibalize space science programs. The committee agrees with the statement by the Human Spaceflight Plans Committee report that “it is essential that budgetary firewalls be built between these two broad categories of activity. Without such a mechanism, turmoil is assured and program balance endangered.”⁵

Within the planetary science program there have been and will likely continue to be peer reviewed missions selected that are destined for likely targets of human exploration. The committee believes that **it is vital to maintain the science focus of such peer-reviewed missions and not to incorporate human exploration requirements after the mission has been selected and development has begun.** If the data gathered by such missions have utility for human exploration, the analysis should be paid for by the human exploration program and firewalled from the science budget. Similarly, if the human exploration program proposes a precursor mission (like LRO) and there is an opportunity for conducting science at the destination, science should be very cautious about directly or indirectly imposing mission-defining requirements, and be willing to pay for any such requirements. The need for caution does not rule out the possibility of carefully crafted collaborations, however.

What should be the roles of humans and robots to meet the goals of planetary exploration? The committee reached the same conclusion as past NRC studies that **most of the key scientific lunar and NEO exploration goals can be achieved robotically.** Scientifically useful investigations should still be developed to augment human missions to the Moon or NEOs. The committee **urges the human exploration program to examine this decadal survey and identify—in close coordination and negotiation with the SMD—objectives where human-tended science may advance our fundamental knowledge.** Finding and collecting the most scientifically valuable samples for return to Earth may become, as it was in the Apollo program, the single most important function of a human explorer on the Moon or an asteroid.

For several decades, the NRC has conducted studies of the scientific utility of human explorers or human-robotic exploration teams for exploring the solar system. Invariably, the target of greatest interest has been Mars. The scientific rationale cited has largely focused on answering questions relating to the search for past or present biological activity. Based on the importance of questions relating to life, the

committee concluded that for the more distant future, human explorers with robotic assistance may contribute more to the scientific exploration of Mars than they can to any other body in the solar system.

International Cooperation

Planetary exploration is an increasingly international endeavor, with the United States, Russia, Europe, Japan, Canada, China, and India independently or collaboratively mounting major planetary missions. As budgets for space programs come under increasing pressure and the complexity of the missions grows, international cooperation becomes an enabling component. New alliances and mechanisms to cooperate are emerging, enabling partners to improve national capabilities, share costs, build common interests, and eliminate duplication of effort. But international agreements and plans for cooperation must be crafted with care, for they also can carry risks. The management of international missions adds layers of complexity to their technical specification, management, and implementation. Different space agencies use different planning horizons, funding approaches, selection processes, and data dissemination policies. Nonetheless, international cooperation remains a crucial element of the planetary program; it may be the only realistic option to undertake some of the most ambitious and scientifically rewarding missions.

In considering international cooperation, the committee draws from the general principles and guidelines laid out in past studies, in particular the joint report of the Space Studies Board and the European Space Science Committee entitled, *U.S.-European Collaboration In Space Science*.⁶ Following examination of a series of case studies examining the positive and negative aspects of past transatlantic cooperative space-science ventures, the committee laid out eight essential ingredients that an agreement to engage in an international collaboration must contain; they are as follows:

1. *Scientific support through peer review that affirms the scientific integrity, value, requirements, and benefits of a cooperative mission;*
2. *An historical foundation built on an existing international community, partnership, and shared scientific experiences;*
3. *Shared objectives that incorporate the interests of scientists, engineers, and managers in common and communicated goals;*
4. *Clearly defined responsibilities and roles for cooperative partners, including scientists, engineers, and mission managers;*
5. *An agreed-upon process for data calibration, validation, access, and distribution;*
6. *A sense of partnership recognizing the unique contributions of each participant;*
7. *Beneficial characteristics of cooperation; and*
8. *Recognition of the importance of reviews for cooperative activities in the conceptual, developmental, active, or extended mission phases—particularly for foreseen and upcoming large missions.*

NSF ACTIVITIES

The National Science Foundation's principal support for planetary science is provided by the Division of Astronomical Sciences in the Directorate for Mathematical and Physical Sciences. Typical awards are in the range \$95,000 to \$125,000 per year for a nominal 3-year period. The focus of the program is scientific merit with broad impact and the potential for transformative research. NSF also provides peer-reviewed access to telescopes at public facilities (see below). In short, NSF supports nearly all areas of planetary science except space missions, which it supports indirectly through laboratory research and archived data.

The annual budget of NSF/AST is currently approximately \$230 million. Planetary astronomers must compete against all other astronomers for access to both research grants and telescope time, however, so only a small fraction of AST's facilities and budget support planetary science.

Other parts of NSF make small but important contributions to planetary science. The Office of Polar Programs (OPP) provides access to and logistical support for researchers working in Antarctica. OPP's activities are of direct relevance to planetary science because it supports the Antarctic meteorite collection program (jointly with NASA and the Smithsonian Institution), and provides access to analog environments of direct relevance to studies of ancient Mars and the icy satellites of the outer solar system. The Atmospheric and Geospace Sciences Division provides modest support for research concerning planetary atmospheres and magnetospheres. And the Earth Science and Ocean Sciences Divisions have supported studies of meteorites and ice-covered bodies.

Such grants, though small compared with NASA's activities in similar areas, are important because they provide a vital source of funding to researchers mostly to support graduate students and postdoctoral fellows. More importantly, they provide a key linkage between the relatively small community of planetary scientists and the much larger community of researchers studying the Earth.

The committee's overall assessment is that NSF grants and support for field activities are an important source of support for planetary science in the U.S., and should continue.

Ground-Based Astronomical Facilities

NSF is the largest federal funding agency for ground-based astronomy in the United States. NSF-funded activities are of great importance to the planetary sciences. These include the National Optical Astronomy Observatory (NOAO), the Gemini Observatory, the National Astronomy and Ionosphere Center (NAIC), the National Radio Astronomy Observatory (NRAO), and the National Solar Observatory (NSO). Collectively these are known as the National Observatories.

The NOAO operates two 4-meter and other smaller telescopes at the Kitt Peak National Observatory in Arizona and the Cerro Tololo Inter-American Observatory in Chile. **The committee supports the National Observatories' ongoing efforts to provide public access to its system of observational facilities, and encourages the National Observatories to recognize the synergy between ground-based observations and in situ planetary measurements, perhaps through coordinated observing campaigns on mission targets.**

The Gemini Observatory operates two 8-m optical telescopes, one in the southern and one in the northern hemisphere in an international partnership. The Gemini international partnership agreement is currently under renegotiation, and the United Kingdom, which holds a 25 percent stake, has announced its intent to withdraw from the consortium in 2012. This eventuality would provide a good opportunity for increasing the U.S. share of Gemini, and also presents an opportunity for restructuring the complex governance and management structure.⁷ The Gemini partnership might consider the advantages of stronger scientific coordination with NASA mission planning needs.

NAIC operates the Arecibo Observatory in Puerto Rico. Arecibo is a unique and important radar facility that plays a particularly important role in NEO studies.

NRAO operates the Very Large Array (VLA) and the Atacama Large Millimeter Array (ALMA), both of which are of great importance to future planetary exploration. The expanded VLA will produce imaging of the planets across the microwave spectrum, and also provide a back-up downlink location to the DSN. ALMA, will provide unprecedented imaging in the relatively unexplored wavelength region of 0.3 mm to 3.6 mm (84 to 950 GHz).

NSO operates telescopes on Kitt Peak and Sacramento Peak, New Mexico, and six worldwide Global Oscillations Network Group stations. Understanding the Sun is critical to understanding its relationship to planetary atmospheres and surfaces. **The committee endorses and echoes the astronomy decadal survey report's recommendation that "the NSF should work with the solar, heliospheric, stellar, planetary, and geospace communities to determine the best route to an effective and**

balanced ground-based solar astronomy program that maintains multidisciplinary ties.”

Many important advances in planetary research have come from access to private facilities such as the Keck, Magellan, and MMT observatories via NSF’s Telescope System Instrumentation Program. **The ground-based observational facilities supported wholly or in part by NSF are essential to planetary astronomical observations, both in support of active space missions and in studies independent of (or as follow up to) such missions. Their continued support is critical to the advancement of planetary science.**

One of the future NSF-funded facilities most important to planetary science is the Large Synoptic Survey Telescope (LSST).⁸ LSST will discover many small bodies in the solar system, some of which will require follow-up observations for the study of their physical properties. Some of these bodies are likely to be attractive candidates for future spacecraft missions. **The committee encourages the timely completion of LSST, and stresses the importance of its contributions to planetary science, as well as astrophysics, once telescope operations begin.**

With apertures of 30 meters and larger, extremely large telescopes (ELTs) will play a significant future role in planetary science. International efforts for ELT development are proceeding rapidly, with at least three such telescopes in planning stages: the Giant Magellan Telescope, the Thirty-Meter Telescope, and the European Extremely Large Telescope. **The committee does not provide specific guidance to NSF on this issue. It endorses the recommendations and support for these facilities made by the 2010 Astronomy and Astrophysics Decadal Survey and encourages NSF to continue to invest in the development of ELTs and to seek partnerships to ensure that at least one such facility comes to fruition with some public access. The committee believes that it is essential that the design of ELTs accommodate the requirements of planetary science to acquire and observe targets that are moving, extended, and/or bright, and that the needs of planetary mission planning be considered in awarding and scheduling public time for ELTs.**

Laboratory Studies and Facilities for Planetary Science

In order to maximize the scientific return from NSF-funded ground-based observations and NASA space missions alike, materials and processes must be studied in the laboratory. Laboratory data supporting planetary science activities include development of large spectroscopic databases for gases and solid over a wide range of wavelengths, including derivation of optical constants for solid materials, laboratory simulations of aerosol physics and chemistry, and measurements of thermophysical properties of planetary materials. Planetary science intersects with many areas of astrophysics that receive NSF funding for laboratory investigations. Although laboratory research costs a fraction of missions, in most areas it receives insufficient support, with the result that existing infrastructure is often not state of the art and required upgrades cannot be made. NSF can make a huge impact on planetary science by supporting this vital area of research. **The committee recommends expansion of NSF funding for the support of planetary science in existing laboratories, and the establishment of new laboratories as needs develop.** Areas of high priority for support include the following:

- Development and maintenance of spectral reference libraries for atmospheric and surface composition studies, extending from X-ray to mm wavelengths;
- Laboratory measurements of thermophysical properties of materials over the range of conditions relevant to planetary objects;
- Investment in laboratory infrastructure and support for laboratory spectroscopy (experimental and theoretical), perhaps through a network of general user laboratory facilities; and
- Investigations of the physics and chemistry of aerosols in planetary atmospheres through laboratory simulations.

The ties between planetary science and laboratory astrophysics will continue to strengthen and

PREPUBLICATION COPY—SUBJECT TO FURTHER EDITORIAL CORRECTION

S-23

draw closer with the expanding exploration of exoplanets and the development of techniques to study their physical-chemical properties.

NOTES

1. National Research Council, *New Frontiers in the Solar System: An Integrated Exploration Strategy*, The National Academies Press, Washington, D.C., 2003.

2. This is the cost of MAX-C only, not the cost of the full Mars Sample Return campaign. Also, the estimate is for the MAX-C mission as currently conceived; below we recommend reductions in scope to keep the cost below \$2.5 billion FY2015.

3. Version without solar-electric propulsion stage.

4. The issue of instrument development problems is a subtler one, as instrument overruns alone may represent a small fraction of mission cost, but they can have profound effects on project schedules and induce additional costs beyond those associated with the instrument. This is likely to be a significant problem in the next decade in the wake of the dramatic reductions in technology development spending this past decade that have resulted in fewer mid- to high-TRL instruments being available for flight.

5. Review of U.S. Human Spaceflight Committee, *Seeking a Human Spaceflight Program Worthy of a Great Nation*, Executive Office of the President, Washington, D.C., 2009.

6. National Research Council and European Science Foundation, *U.S.-European Collaboration In Space Science*, National Academy Press, Washington, D.C., 1998, pp. 102-103.

7. For additional details concerning Gemini and recommendations for its future, see, for example, National Research Council, *New Worlds, New Horizons in Astronomy and Astrophysics*, The National Academies Press, Washington, D.C., 2010, pp. 177-179.

8. For additional information about and recommendations concerning the LSST, see, for example, National Research Council, *New Worlds, New Horizons in Astronomy and Astrophysics*, The National Academies Press, Washington, D.C., 2010, pp. 224-225.

1**Introduction to Planetary Science**

How do planets form? What combination initial conditions and subsequent geologic, chemical, and biological processes led to at least one planet becoming the abode for innumerable lifeforms? What determines the fate of life on a planet? Such scientific enquiries reflect a basic human need to understand who we are, where we came from, and what the future has in store for humanity. “Planetary science” is shorthand for the broad array of scientific disciplines that collectively seek answers to these and related questions.

THE MOTIVATIONS FOR PLANETARY SCIENCE

In the past, scientists only had one planet to study in detail. Our Earth, however, the only place where life demonstrably exists and thrives, is a complex interwoven system of atmosphere, hydrosphere, lithosphere, and biosphere. Today, planetary scientists can apply their knowledge to the whole solar system, and to hundreds of worlds around other stars. By investigating planetary properties and processes in different settings, some of them far simpler than Earth, we gain substantial advances in understanding exactly how planets form, how the complex interplay of diverse physical and chemical processes create the diversity of planetary environments seen in the solar system today, and how interactions between the physical and chemical processes on at least one of those planets led to creation of conditions favoring the origin and evolution of multifarious forms of life. These basic motivational threads will be built upon and developed into the three principal scientific themes of this report—building new worlds, workings of solar systems, and planetary habitats—in Chapter 3.

Current understanding of Earth’s surface and climate are constrained by studies of the physical process operating on other worlds. The destructive role of chlorofluorocarbons in Earth’s atmosphere was recognized by a scientist studying chemistry on Venus. Knowledge of the “greenhouse” effect, a mechanism in the ongoing global warming on Earth, likewise came from studies of Venus. Comparative studies of the atmospheres of Mars, Venus, and Earth yield critical insights into the evolutionary histories of terrestrial planet atmospheres. Similarly, studies of the crater-pocked surface of the Moon led to current understanding of the key role played by impacts in shaping planetary environments. The insights derived from studies of lunar craters led to the realization that destructive impacts have wreaked havoc on Earth in the distant past, and as recently as 100 years ago, a devastating blast in Siberia leveled trees over an area the size of metropolitan Washington DC. Three recent impacts on Jupiter provide our best laboratory for studying the mechanics of such biosphere-disrupting events. Wind-driven processes that shape Earth’s desert dunes operate on Mars and even on Saturn’s moon Titan.

Planetary science transcends national boundaries. Even during the depths of the Cold War, planetary scientists from both east and west frequently cooperated, by exchanging samples from their respective lunar missions or by coordinating their independent missions to Halley’s Comet. Now, decades later, planetary science is a truly global endeavor. Spacecraft that explore the planets come not only from the United States, but also from China, India, Japan, and the nations of Western Europe. If we expand the list to include nations with some space-based capacity—those that use spacecraft data, build spacecraft instruments, operate relevant ground-based facilities, or contribute in some other way to the advancement of planetary science—planetary science encompasses the globe.

PREPUBLICATION COPY—SUBJECT TO FURTHER EDITORIAL CORRECTION

This chapter reviews the recommendations of the most recent planetary decadal survey, and summarizes some of the most exciting recent scientific achievements. The chapter concludes with a discussion of the organization of this report, articulating how this and subsequent chapters relate to the committee's statement of task (Appendix A).

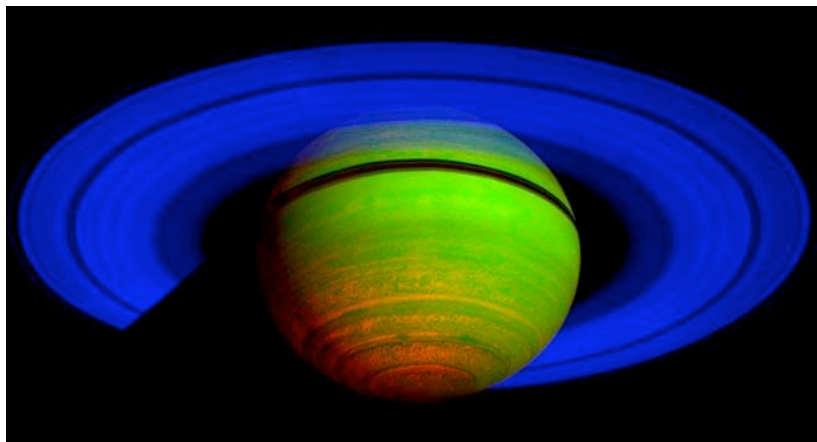

FIGURE 1.1 Saturn as imaged by the Cassini spacecraft. SOURCE: NASA/JPL.

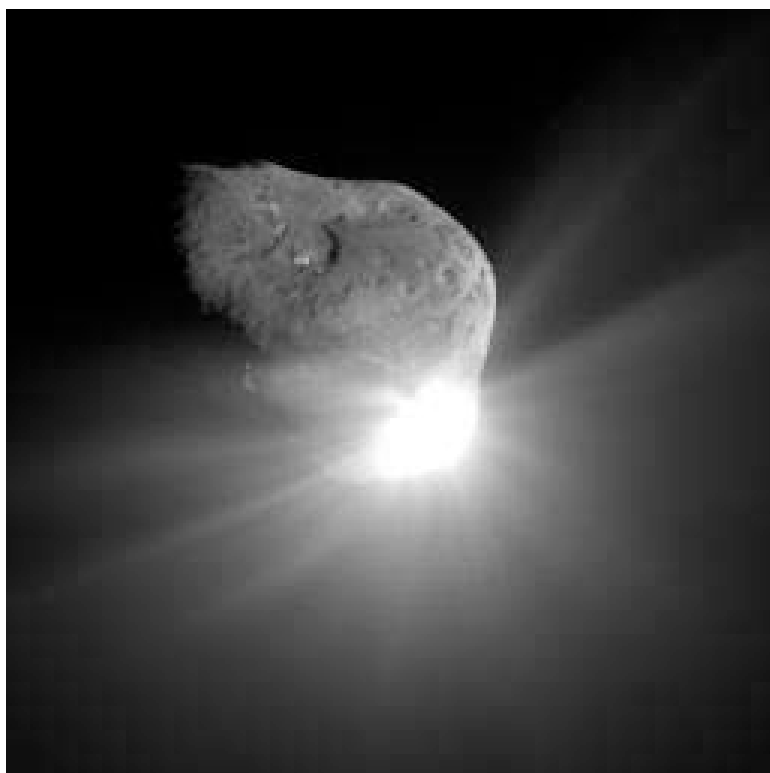

FIGURE 1.2 The comet Tempel 1 at the moment it was struck by the impactor from the Deep Impact spacecraft on July 4, 2005. SOURCE: NASA/JPL-Caltech/UMD.

THE 2002 SOLAR SYSTEM EXPLORATION DECADAL SURVEY

In the 1970s and 1980s, science strategies for exploring the solar system were drafted by the NRC's Committee on Planetary and Lunar Exploration (COMPLEX), which addressed separately the inner planets, the outer planets, and primitive bodies. Early in the 1990s, COMPLEX crafted a single solar system strategy that united and updated the several preexisting documents. The resulting report, *An Integrated Strategy for the Planetary Sciences: 1995-2010*,¹ showed that it was both feasible and appropriate to establish a set of self-consistent, solar system wide priorities for planetary science. The *Integrated Strategy* provided the foundation upon which the planetary community's first decadal survey was built, with the process starting in 2001. Unlike the precursor reports from COMPLEX, which only considered scientific goals, the 2002 decadal survey—*New Frontiers in the Solar System: An Integrated Exploration Strategy*—both outlined science priorities and identified new initiatives needed to address those priorities.² The study also advocated the creation of a new class of medium-sized missions, named New Frontiers.

The 2002 decadal survey's statement of task from NASA called for prioritized missions binned in small, medium and large categories with respective costs of less than \$325 million, less than \$650 million, and more than \$650 million in then-year dollars. That survey prioritized Mars missions separately from missions to other solar system destinations. This report provides status updates for the recommended missions.



FIGURE 1.3 A rock outcrop on Mars named “Clovis,” drilled and brushed by the Mars Exploration Rover Spirit in August 2004. SOURCE: JPL/NASA/Cornell.



FIGURE 1.4 Launch of the New Horizons mission in January 2006. New Horizons is the first of the New Frontiers missions and was a top priority in the last decadal survey. New Horizons explores a completely new region of the solar system, the Kuiper Belt, a region discovered by ground-based observers. SOURCE: NASA.

Non-Mars Mission Priorities in 2002

Large

Europa Geophysical Explorer was the only large mission identified: a spacecraft to orbit Europa and determine the nature and depth of the subsurface ocean postulated to exist beneath Europa's ice shell. Although much planning has occurred, the mission has not been initiated. Current efforts focus on implementing this mission in the context of a joint NASA-ESA Europa Jupiter System Mission (Chapters 8 and 9).

Medium

The first decadal survey identified five medium-class initiatives to collectively initiate the competitively selected line of New Frontiers missions. These initiatives were, in priority order:

1. *Kuiper Belt-Pluto Explorer*—A mission to perform the initial spacecraft reconnaissance of the Pluto/Charon system as well as one or more other Kuiper belt objects. This mission is currently being implemented as the New Horizons mission launched in 2006 and scheduled to reach Pluto in 2015 (Figure 1.4). Subsequently, the spacecraft will be redirected so that it passes near to at least one additional Kuiper belt object, as was recommended in the 2002 planetary sciences decadal survey.

2. *South Pole-Aitken Basin Sample Return*—A mission to return a sample from the oldest and deepest impact basin on the Moon. An implementation of this mission called MoonRise was a runner up for the second New Frontiers selection and is currently a finalist for the third. Selection of the third New Frontiers mission is scheduled for 2011.

3. *Jupiter Polar Orbiter with Probes*—A mission to determine the internal structure of Jupiter. An implementation of this priority without probes called Juno was selected as the second New Frontiers mission. Juno is scheduled for launch in 2011 (Figure 1.5).

4. *Venus In Situ Explorer*—A mission to determine the geochemical characteristics of the surface of Venus and to study its atmosphere. An implementation of this mission was a runner up for the second New Frontiers selection and a new concept call the Surface and Atmosphere Geochemical Explorer (SAGE) is currently a finalist for the third selection.

5. *Comet Surface Sample Return*—A mission to collect and return surface samples of a comet to Earth. This mission has not yet been attempted.

The selection of New Horizons and Juno as the first two New Frontiers missions prompted NASA in 2007 to request a new NRC study to suggest additional candidate missions to supplement the remaining three. The subsequent report, *Opening New Frontiers in Space: Choices for the Next New Frontiers Announcement of Opportunity*,³ identified five additional candidates. They were, in alphabetical order:

- *Asteroid Rover/Sample Return*—A mission to rendezvous with an asteroid, land, collect surface samples, and return them to Earth for analysis. An implementation of this mission called the Origins Spectral Interpretation Resource Identification Security-Regolith Explorer (OSIRIS-REx) is currently a finalist for the third New Frontiers launch opportunity.
- *Ganymede Observer*—A mission to perform detailed studies of the third of Jupiter's Galilean satellites, the largest satellite in the solar system.
- *Io Observer*—A mission to study the innermost of Jupiter's Galilean satellites, the most volcanically active body in the solar system.
- *Network Science*—A mission to deploy an array of small landers on the Moon or one of the terrestrial planets to perform coordinated geophysical and/or meteorological observations.
- *Trojan/Centaur/Reconnaissance*—A mission to perform the initial characterization of one or more Trojan asteroids and a Centaur.



FIGURE 1.5 The Juno mission to Jupiter under construction. SOURCE: NASA/JPL-Caltech/Lockheed Martin Space Systems.

Small

The first decadal survey identified two small-class initiatives. They were, in priority order:

1. *Discovery Program*. The 2002 survey recommended that the Discovery line of innovative, principal-investigator-led missions should continue and that a new one should be launched approximately every 18 months. This mission line has continued but the flight rate has not matched the first decadal survey's expectations..

2. *Cassini Extended Mission*. The 2002 decadal survey recommended that the Cassini Saturn orbiter mission be extended beyond its 4-year nominal lifetime. Operation of this highly successful and scientifically productive spacecraft now extends through 2017.

Mars Mission Priorities in 2002

Large

Mars Sample Return. Although no large Mars mission was recommended, the survey called for initiation of the technology development necessary to enable a mission to collect and return martian samples to Earth in subsequent decades. Much programmatic planning and scientific groundwork has been performed to determine how such a mission might be undertaken, but not all of the necessary technology development has taken place (Figure 1.6).



FIGURE 1.6 Victoria crater as imaged by the Mars Reconnaissance Orbiter. The Opportunity rover traversed the edge of this crater before venturing into it. SOURCE: NASA/JPL-Caltech/University of Arizona.

Medium

The survey identified two medium-class Mars initiatives. They were, in priority order:

1. *Mars Science Laboratory*—At the time the survey was carried out, this mission was understood to be a lander capable of carrying out sophisticated surface observations and validating some of the technologies for a sample-return mission. Since then, the concept has evolved into a large, highly capable rover mission with a comprehensive payload of remote and in situ instruments. In the process, the cost of the mission grew substantially, to more than \$2 billion. Launch is scheduled for 2011.

2. *Mars Long-Lived Lander Network*—This globally distributed array of small landers would be equipped to make comprehensive measurements concerning Mars’s interior, surface, and atmosphere. It has not yet been implemented.

Small

Two small-class missions were identified. In priority order they were:

1. *Mars Scout Program*— This line of competitively selected missions is similar in concept to the Discovery Program. The survey envisaged one such mission every other Mars launch opportunity. Two Scout missions have been selected: Phoenix was selected in 2003 and launched in 2007; and the Mars Atmosphere and Volatile Evolution (MAVEN) mission selected in 2008 for launch in 2013. Subsequently, the program was combined with Discovery.

2. *Mars Upper Atmosphere Orbiter*—This is an orbiter dedicated to studies of Mars’s upper atmosphere and plasma environment. The MAVEN mission, selected for the second and final Mars Scout launch opportunity, addresses the goals of this concept.



FIGURE 1.7 Mars Science Laboratory Curiosity rover undergoing a test of its sample arm while on a tilt table at the Jet Propulsion Laboratory in September 2010. SOURCE: NASA/JPL-Caltech.

Research Infrastructure

In addition to identifying high priority spacecraft missions, the previous decadal survey singled out two important new pieces of ground-based research infrastructure. They were, in alphabetical order:

- *Giant Segmented Mirror Telescope*—This 30-meter-class general purpose, optical telescope would be equipped with adaptive optics. The construction of such a facility has been a high priority in the last two astronomy decadal surveys. At least three consortia—one in Europe and two in the U.S.—have developing plans and raising the funds necessary to begin construction of such a telescope.
- *Large Synoptic Survey Telescope*—This 8-meter-class special purpose, wide-field telescope will survey the entire visible sky every three nights. This facility was the highest priority ground-based initiative identified in the most recent astronomy decadal survey and ranked highly in the one before that. It is envisaged as being constructed and operated via a public-private consortium (Figure 1.8).

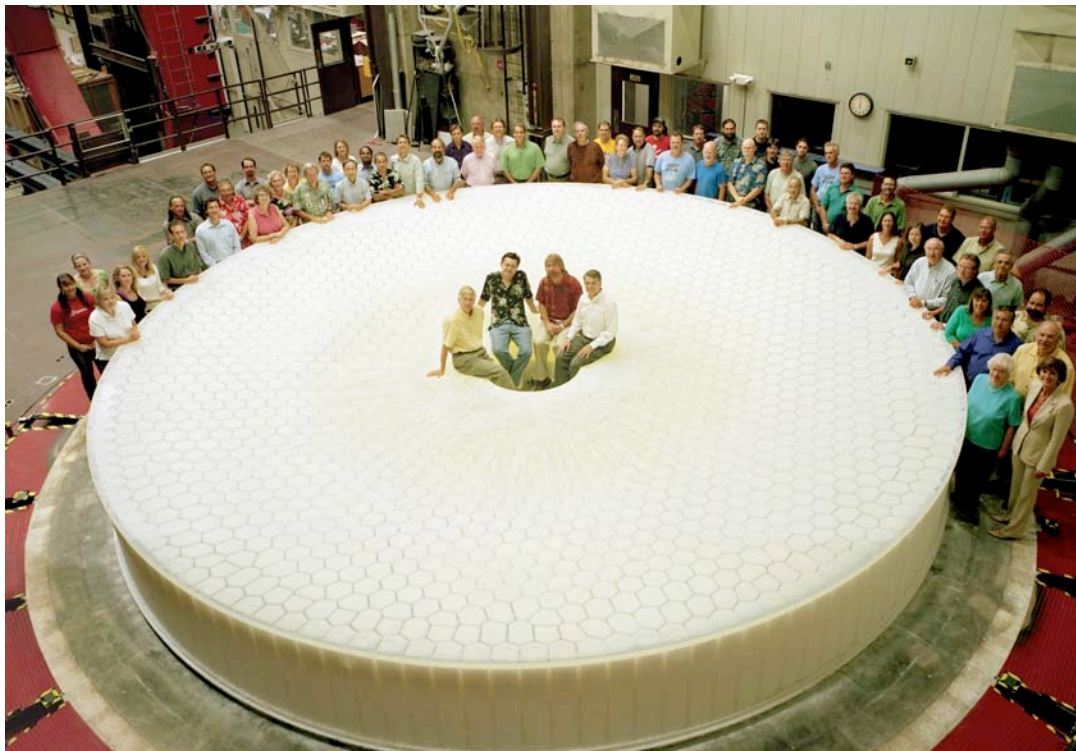

FIGURE 1.8 The mirror for the Large Synoptic Survey Telescope prior to polishing and grinding.
SOURCE: Howard Lester / LSST Corporation.

RECENT ACHIEVEMENTS IN PLANETARY SCIENCE

Twelve discoveries made since the publication of the last planetary decadal survey illustrate the vitality and diversity of planetary science. These discoveries represent just a small fraction of the advances in planetary sciences over the last decade (see Chapters 4-8 for additional achievements).

- *An explosion in the number of known exoplanets.* Confirmed examples have grown from a few dozen at the beginning of this decade to many hundreds, including numerous multi-planet systems. Multiple lines of evidence suggest that the majority are Uranus- and Neptune-size bodies including microlensing surveys that seem to account for selection effects.
- *The Moon is less dry than once thought.* Evidence is mounting that the lunar surface and interior is not completely dry as previously believed. Apollo samples now show the Moon's interior to hold more water than thought. Observations from Lunar Prospector, LRO, LCROSS, Cassini, and Chandrayaan-1 also suggest small, but significant, quantities of water on the Moon: including exospheric and exogenic water generated by solar wind proton reduction and cometary deposits in the extremely cold regions of the lunar poles.
- *Minerals that must have formed in a diverse set of aqueous environments throughout martian history.* Observations from multiple orbiters and rovers have identified a broad suite of water-related minerals including sulfates, phyllosilicates, iron oxides and oxyhydroxides, chlorides, iron and magnesium clays, carbonates, and hydrated amorphous silica.
- *Extensive deposits of near-surface ice on Mars.* These deposits are a major reservoir of martian water, and because of oscillating climate conditions, potentially lead to geologically brief periods of locally available liquid water.

PREPUBLICATION COPY—SUBJECT TO FURTHER EDITORIAL CORRECTION

1-9

- *An active meteorological cycle involving liquid methane on Titan.* Observations from Cassini and Huygens have confirmed the long-suspected presence of complex organic processes on Titan. Moreover, they have revealed that an active global methane cycle mimics Earth's water cycle.
- *Dramatic changes in the atmospheres of the giant planets.* Notable examples include: observations of three impacts on Jupiter in 2009-2010; striking atmospheric seasonal change on Saturn and Uranus; evidence for vigorous polar vortices on Saturn and Neptune; and the discovery of rapid changes in the ring systems of Jupiter, Saturn, Uranus, and Neptune.
- *Recent volcanic activity on Venus.* The European Space Agency's Venus Express spacecraft has found zones of higher emissivity associated with volcanic regions, suggestive of recent volcanic activity. If correct this supports models postulating that ongoing volcanic emission of SO₂ feeds the global H₂SO₄ clouds.
- *Geothermal and plume activity at the south pole of Enceladus.* Observations by the Cassini spacecraft have revealed anomalous sources of geothermal energy coincident with curious rifts in the south polar region of Enceladus. The energy source appears to be responsible for plumes of ice particles and organic materials that emanate from discrete locations along the rifts.
- *The anomalous isotopic composition of the planets.* Analysis of data from the Genesis solar wind sample return mission has revealed that the Sun is highly enriched in oxygen-16. The long-standing belief was that, relative to the planets, the Sun was depleted in this isotope. The only materials that seem to have the average solar system composition of oxygen, besides the Sun, are refractory inclusions in chondrites. Some unknown process must be depleting the protoplanetary nebula's oxygen-16 prior to the formation of the planets.
- *The differentiated nature of comet dust.* Analysis of samples returned by the Stardust mission revealed that cometary dust contains minerals that can only form at high temperatures, close to the Sun. This result has changed ideas concerning the physical processes within the protoplanetary disk (Figure 1.10).
- *Mercury's liquid core.* Radar signals transmitted from NASA's Deep Space Network station in California and detected by NRAO's Green Bank Telescope detected Mercury's forced libration and demonstrated that the planet has a liquid core.
- *The richness and diversity of the Kuiper Belt.* A combination of ground- and space-based telescopic studies has revealed the diversity of the icy bodies forming the Kuiper Belt. This diversity includes many objects as large as or larger than Pluto and, intriguingly, a large proportion of binary and multi-object systems (Figure 1.11).

Each of these recent achievements is a response to one or more of the basic motivations introduced at the beginning of this chapter that make planetary science a compelling field of study. Some of these achievements provide information on how planets form. Others say something about the physical and chemical processes that create planetary environments. Still others reveal something about the processes creating conditions favorable to life. The hallmark of these recent discoveries is their variety. From Mercury to the Kuiper belt at the solar system's edge, from huge Jupiter to miniscule comet dust, no one class of objects dominates. Discoveries such as the plumes on Enceladus and the methane cycle on Titan were made by a NASA-ESA flagship mission. Other discoveries, such as the realization that cometary dust contains minerals that must have formed at high temperatures close to the Sun, came from small spacecraft costing a fraction of the cost of a flagship mission. Additional discoveries were made with ground-based telescopes supported by NSF and other national science agencies. Some of these discoveries were made by space-based telescopes supported by NASA and international space agencies; others—such as the recent spate of impacts on Jupiter—were found by amateur astronomers using backyard telescopes. In short, there is no one best way to do planetary science. A program that advances on a broad front is most likely to yield success.

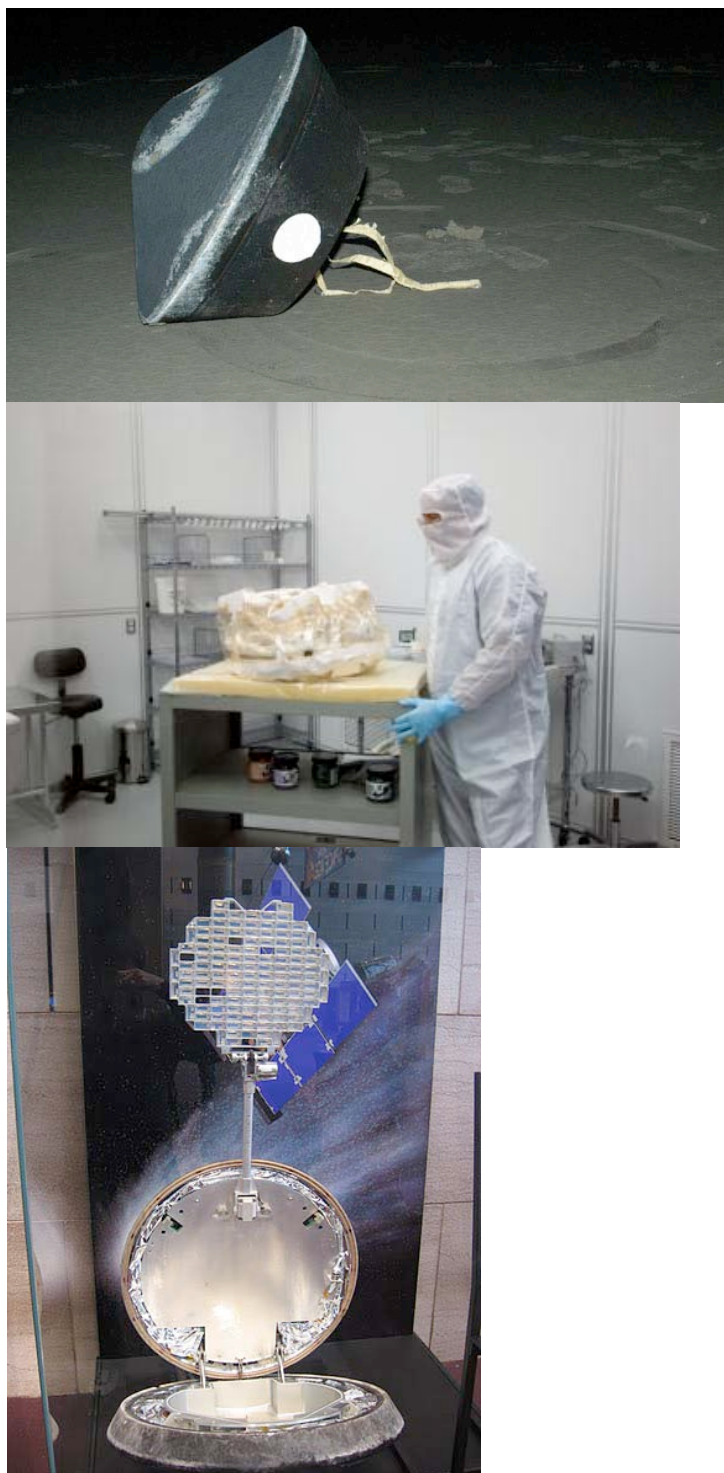

FIGURE 1.10 From a comet, to the desert, to the laboratory, to the Smithsonian—the Stardust mission encountered the comet Wild 2 in January 2004, and returned samples to Earth in January 2006 (*top*). The samples are still being examined but have provided new understandings of our solar system. The capsule now resides in the National Air and Space Museum (*bottom*). SOURCE: *Top, middle:* NASA/JPL. *Bottom:* Smithsonian National Air and Space Museum.

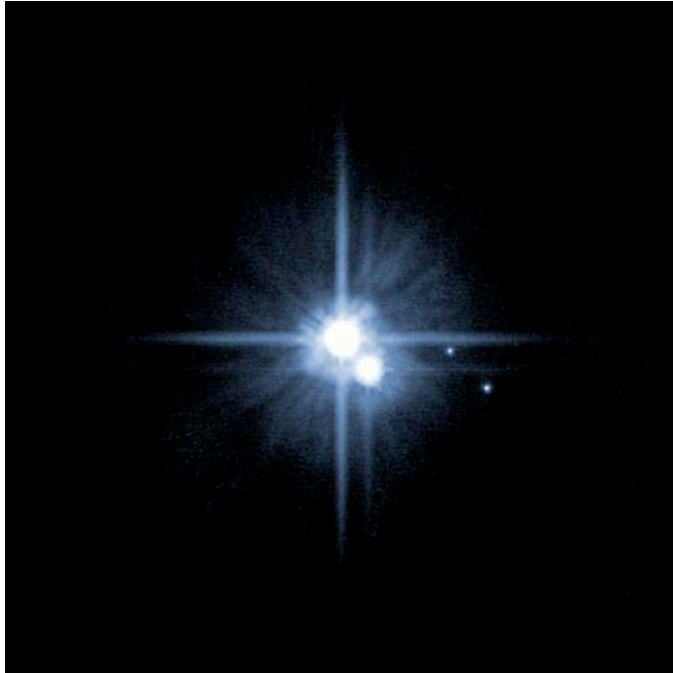

FIGURE 1.11 Pluto and its large moon Charon, and two smaller moons, Nix and Hydra, discovered in 2005. SOURCE: NASA, ESA, H. Weaver (JHUAPL), A. Stern (SwRI), and the HST Pluto Companion Search Team.

SCOPE OF THIS REPORT

The scientific scope of this report spans two dimensions: first, the principal scientific disciplines that collectively encompass the ground- and space-based elements of planetary science: i.e., planetary astronomy, geology, geophysics, atmospheric science, magnetohydrodynamics, celestial mechanics, and astrobiology; and second, the physical territory within the committee’s purview; the solar system’s principal constituents. This territory includes the following.

- The major rocky bodies in the inner solar system: i.e., Mercury, Venus, the Moon, and Mars.
- The giant planets in the outer solar system—i.e., Jupiter, Saturn, Uranus, and Neptune—including their rings and magnetospheres.
- The satellites of the giant planets.
- Primitive solar system bodies: i.e., the comets, asteroids, satellites of Mars, interplanetary dust, meteorites, Centaurs, Trojans, and Kuiper belt objects.

The committee imposed programmatic boundary conditions, largely derived from our statement of task, to ensure that this report contains actionable advice:

- The principal findings and recommendations contained in *New Frontiers in the Solar System* and more recent NRC reports relevant to planetary science activities were assessed, and incorporated where appropriate. Missions identified in those past reports were reprioritized if they had not yet been confirmed for implementation.
- Priorities for spacecraft missions to the Moon, Mars and other solar system bodies were treated in a unified manner with no predetermined “set asides” for specific bodies. This differs distinctly from the ground rules for the last planetary decadal survey, where missions to Mars were prioritized separately.

PREPUBLICATION COPY—SUBJECT TO FURTHER EDITORIAL CORRECTION

- The committee's programmatic recommendations were designed to be achievable within the boundaries of anticipated NASA and NSF funding.
- The report is cognizant of the current statutory roles of the National Science Foundation and NASA, and how these roles may or may not be consistent with current practices within these agencies regarding support for specific activities—e.g., the funding mechanisms, construction and operation of ground-based observatories.
- The report reflects an awareness of the science and space mission plans and priorities of potential foreign and U.S. agency partners (such as the Department of Energy for Pu-238 and the Department of Defense for launch vehicles). This report's recommendations are, however, addressed to NASA and NSF.

To maintain consistency with other advice developed by the NRC and to ensure that this report clearly addresses those topics identified in the committee's statement of task, the following topics were not addressed in this report.

- Issues relating to the hazards posed by near-Earth objects and approaches to hazard mitigation. Relevant material on the hazard issue is contained in *Defending Planet Earth: Near-Earth-Object Surveys and Hazard Mitigation Strategies*.⁴ However, scientific studies of near-Earth asteroids are discussed in this report.
- Study of the Earth system, including its atmosphere, magnetosphere, surface, and interior. A relevant discussion of these topics and recommendations relating to them can be found in *Earth Science and Applications from Space—National Imperatives for the Next Decade and Beyond*.⁵
- Studies of solar and heliospheric phenomena, with the exception of interactions with the atmospheres, magnetospheres, and surfaces of solar system bodies. A relevant discussion of solar and heliophysics phenomena can be found in *The Sun to the Earth—and Beyond: A Decadal Research Strategy in Solar and Space Physics* and in a new heliophysics decadal survey scheduled for publication in 2012.⁶
- Ground- and space-based studies to detect and characterize extrasolar planets. Details and recommendations relating to the detection and characterization of extrasolar planets and other aspects of contemporary stellar, galactic, and extragalactic astronomy are found in *New Worlds, New Horizons in Astronomy and Astrophysics*.⁷ This report does contain, however, a discussion of the scientific issues concerning the comparative planetology of the solar system's planets and extrasolar planets, together with issues related to the formation and evolution of planetary system.



FIGURE 1.12 Titan beyond Saturn and its rings, as viewed by Cassini on May 10, 2006. SOURCE: NASA/JPL/Space Science Institute.

ORGANIZATION OF THIS REPORT

The committee's statement of task (Appendix A) calls for this report to contain three principal elements: a survey of planetary science, an assessment of and recommendations relating to NASA activities, and an assessment of and recommendations relating to NSF activities. The following sections map its chapters onto the specific tasks the committee was asked to address.

Survey of the Planetary Sciences

- *Overview of planetary science, what it is, why it is a compelling undertaking, and the relationship between space- and ground-based planetary science research*—The scientific context is discussed in Chapter 1 and the relationship between space- and ground-based research and related programmatic issues relating to planetary science activities at NASA and NSF is found in Chapter 2.
- *Survey of the current state of knowledge of the solar system*—A high-level overview of current knowledge, together with a discussion of three crosscutting themes and 10 high priority questions underlying most current activities in this field is found in Chapter 3. The priority questions introduced in Chapter 3 are developed and refined for the primitive bodies, the inner planets, Mars, the giant planets, and the satellites of the giant planets in Chapters 4, 5, 6, 7, and 8, respectively.
- *Inventory of the top-level scientific questions that should guide NASA flight mission investigations and supporting research programs and NSF's activities*—Chapters 4, 5, 6, 7, and 8, and summarized in Chapter 3.

NSF Activities

- *Assessment of NSF support for the planetary sciences*—A detailed discussion of relevant NSF activities, including support for infrastructure and research programs, together with related recommendations is given in Chapter 10.

PREPUBLICATION COPY—SUBJECT TO FURTHER EDITORIAL CORRECTION

- *Opportunities for joint ventures and other forms of international cooperation—Chapter 2 and Chapter 10.*

NASA Activities

- *Optimum balance across the solar system and among small, medium, and large missions and supporting activities—Chapter 9*
 - *Individual flight investigations for initiation between 2013 and 2022—Priority large, medium and small spacecraft missions are discussed, and recommendations supported by decision rules are given, in Chapter 9.*
 - *Supporting research required to maximize the science return from the flight mission investigations—Chapter 10*
 - *Strategic technology development needs and opportunities relevant to NASA planetary science programs—Chapter 11*
 - *Discussion of potential opportunities for conducting planetary science investigations involving humans in situ and the relative value of human-tended investigations to those performed solely robotically—Chapter 2*
 - *Opportunities for international cooperation—Chapter 2 and Chapter 9.*



FIGURE 1.13 Sand cascades on Mars, photographed by the Mars Reconnaissance Orbiter. SOURCE: NASA/JPL/University of Arizona.

A Guide to Reading this Report

There are many ways that individuals can and will read this report. Ideally, every reader will begin at the beginning and work their way through to the end. But, this is not essential. Indeed, the desires of most readers will be satisfied by the selective reading of different parts of this report. The remainder of this section and the adjacent chart (Figure 1.16) serves a reader's guide.

The fundamental principle used to frame this report derives from a hierarchy of science priorities. The core of the report (Chapters 4-9) is devoted to working from major, foundational topics that drive the overall planetary program—the origins of the solar system, the workings of planets, and the conditions that promote the emergence of life (the themes and priority questions discussed in Chapter 3)—to the science missions that the committee has identified as the top planetary science spacecraft activities for the coming decade (Chapter 9).

The major questions forming the foundations of planetary science deal with topics that will almost certainly not be fully addressed in a single decade. Rather, many generations of scientists have already labored over them and additional generations will likely follow suit. The topics discussed in Chapter 3 are too broad and too fundamental to be fully addressed in the period 2013-2022. However, a general reader interested in the current scope of, and key motivations for undertaking, activities in the planetary sciences need only read Chapters 1, 2, and 3. Those general readers interested in a preview of the spacecraft missions recommended for implementation in the decade to come should jump to Chapter 9.

A decadal plan must be based on the identification and exploitation of those components or subcomponents of the big, foundational topics showing the most promise of resolution in the coming 10 years. Chapters 4-8 contain the most basic breakdown of these foundational topics, divided largely in terms of locations in the solar system—i.e., the inner planets (Chapter 5), Mars (Chapter 6), the giant planets (Chapter 7) and their satellites (Chapter 8), and the myriad small bodies that are scattered throughout the solar system (Chapter 4). Thus, Chapters 4-8 are devoted to the identification of the particular aspects of Chapter 3's crosscutting themes and questions showing the greatest promise for resolution in the next 10 years. Chapters 4-8 all follow the same general outline, starting with a link to key science questions in Chapter 3, outlining the science goals, identifying important questions and future directions, addressing any necessary technology development, and finally discussing potential missions.

Some of the big questions can be better addressed at some specific destinations in the solar system rather than others. Chapter 4-8 lay out questions best addressed by visits to the inner planets, to Mars, to the giant planets and their satellites, and to primitive bodies like asteroids and comets, and begin to define the missions that can gather the data that can answer specific aspects of important questions. Thus, readers with a deeper interest in current planetary science research activities should concentrate on Chapters 4-8 and then move on to discussion of high priority spacecraft missions in Chapter 9. If more details are required on the research, infrastructure, and technology required to support these missions, turn to Chapters 10 and 11.

Readers who are most interested in near-term matters of public policy will naturally turn to Chapters 9, 10 and 11 to understand what programs the committee has recommended to initiate or continue to fund, but they will gain a full understanding of why the committee has reached these conclusions by starting with the big questions.

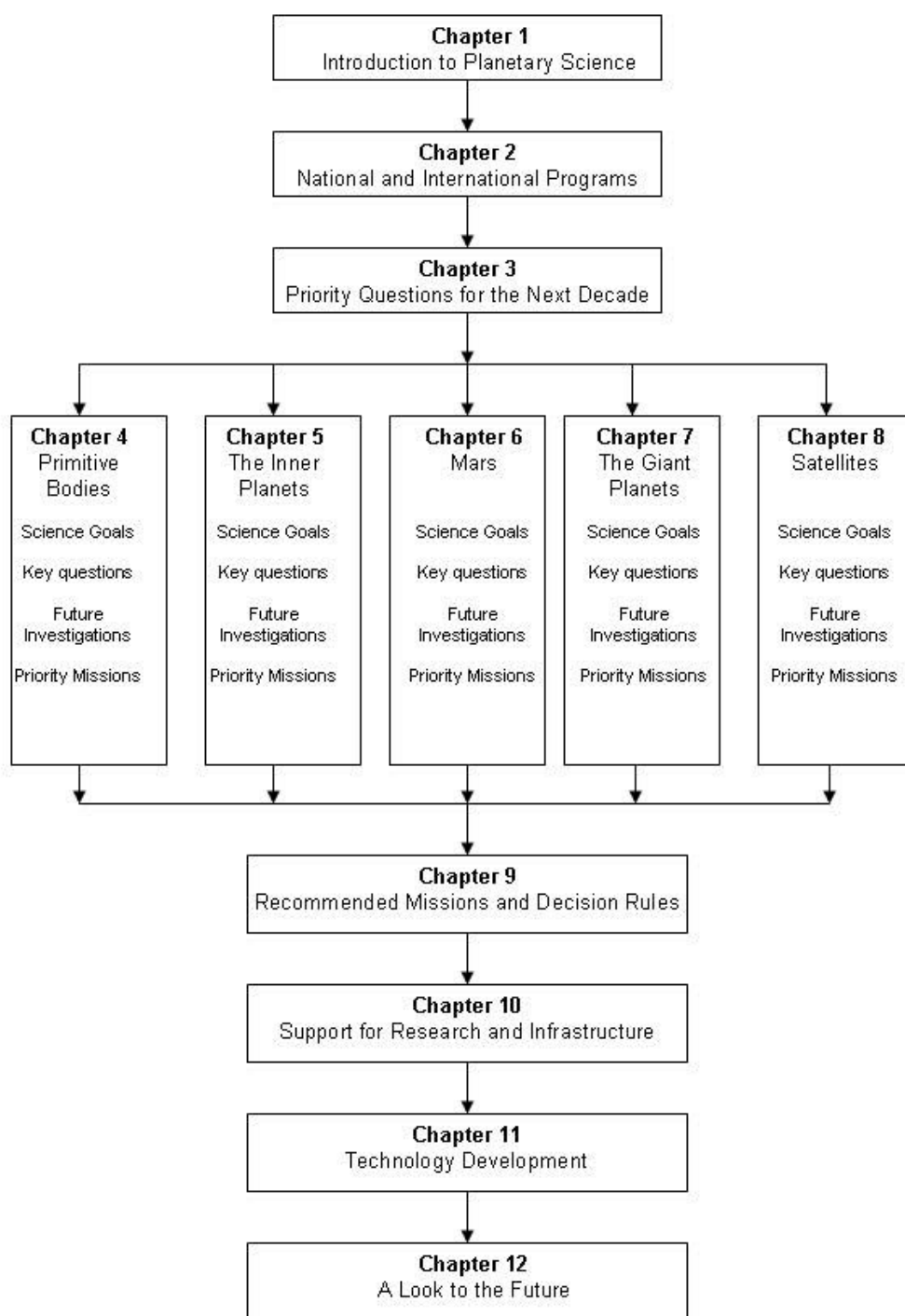

FIGURE 1.14 Schematic showing the flow from one chapter to the next.

REFERENCES

1. National Research Council, *An Integrated Strategy for the Planetary Sciences: 1995-2010*, National Academy Press, Washington, D.C., 1994.
2. National Research Council, *New Frontiers in the Solar System: An Integrated Exploration Strategy*, The National Academies Press, Washington, D.C., 2003.
3. National Research Council, *Opening New Frontiers in Space: Choices for the Next New Frontiers Announcement of Opportunity*, The National Academies Press, Washington, D.C., 2008.
4. National Research Council, *Earth Science and Applications from Space—National Imperatives for the Next Decade and Beyond*, The National Academies Press, Washington, D.C., 2007.
5. National Research Council, *Defending Planet Earth: Near-Earth-Object Surveys and Hazard Mitigation Strategies*, The National Academies Press, Washington, D.C., 2010.
6. National Research Council, *The Sun to the Earth—and Beyond: A Decadal Research Strategy in Solar and Space Physics*, The National Academies Press, Washington, D.C., 2003.
7. National Research Council, *New Worlds, New Horizons in Astronomy and Astrophysics*, The National Academies Press, Washington, D.C., 2010.

2

National and International Programs in Planetary Science**RELATIONSHIPS BETWEEN PLANETARY SCIENCE PROGRAMS AT NASA AND NSF**

The principal federal agencies that support the nation's programs in planetary science are the Planetary Science Division (PSD) of NASA's Science Mission Directorate and the Division of Astronomical Sciences (AST) in NSF's Directorate for Mathematical and Physical Sciences Division.

The primary purpose of NSF-AST is to support research in ground-based astronomy, to provide access to world-class research facilities, and to support the development of new instrumentation and next-generation facilities (Chapter 10). Planetary science directly benefits from NSF's activities in two ways. First, a program of peer-reviewed research grants and postdoctoral fellowships supports individual investigators conducting theoretical, observational and laboratory studies. Such grants support all astronomical disciplines, with no predetermined allocations. Second, NSF provides peer-reviewed access to telescopes at public facilities such as the National Astronomy and Ionosphere Center, the National Radio Astronomy Observatory, the National Optical Astronomy Observatory, and the international Gemini Observatory (Figure 2.1).

The annual budget of NSF-AST is currently approximately \$230 million. Planetary astronomers must compete against all other astronomers for access to both research grants and telescope time, however, and thus only a small fraction of AST's facilities and budget support planetary science.



FIGURE 2.1 The Arecibo Observatory in Puerto Rico. Arecibo is used for radar observation of the Moon, Mars, Venus, Mercury, nearby asteroids, Saturn's rings, and the satellites of Jupiter and Saturn. SOURCE: Courtesy of the NAIC-Arecibo Observatory, a facility of the NSF.

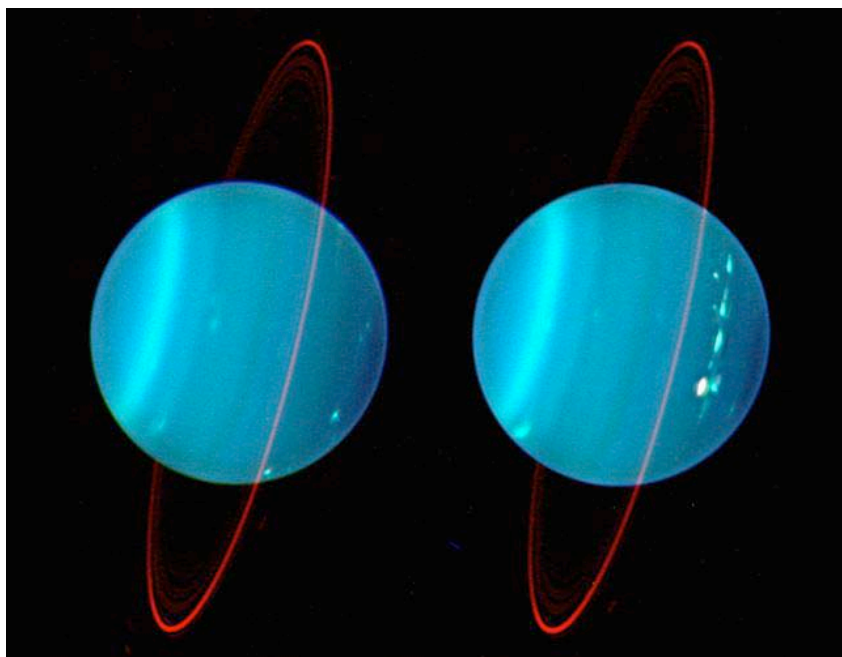

FIGURE 2.2 Images of Uranus taken with the Keck Observatory demonstrating the cloud features that were not visible in Voyager images over two decades ago. SOURCE: Courtesy Lawrence Sromovsky, UW-Madison Space Science and Engineering Center.

The primary goals of NASA’s PSD are to ascertain the origin and evolution of the solar system and to understand the potential for life beyond Earth.¹ These goals are advanced through a combination of spacecraft missions, technology development activities, support for research infrastructure, and research grants. The annual budget of PSD is currently approximately \$1.3 billion. The bulk of this is spent on the development, construction, launch and operation of spacecraft. Two types of spacecraft missions are conducted: large “flagship” missions strategically directed by the PSD, and smaller Discovery and New Frontiers missions proposed and led by principal investigators (PIs) (Chapter 9). The choice and scope of strategic missions is determined through a well-developed planning process, drawing its scientific inputs from advisory groups both internal and external (NRC) to NASA. The PI-led missions are selected by a peer-review process that considers the scientific, technical, and fiscal merit of competing proposals submitted in open competition: proposals can be solicited 1) for investigations at specified planetary targets as determined through a strategic planning process (e.g. New Frontiers) or 2) for investigations unlimited in choice of solar system target and scientific objective (e.g. Discovery).

Technology development activities (Chapter 11) and support for research infrastructure (Chapter 10) are determined through a combination of strategic planning and proposal competition. PSD’s research grants (Chapter 10) are awarded through peer review of proposals submitted to a variety of research programs for analysis of ground- and space-based telescopic observations, theory and modeling, laboratory analyses, terrestrial fieldwork, and analysis of data from past and present missions.



FIGURE 2.3 Sand dunes on Mars photographed by Mars Reconnaissance Orbiter. SOURCE: NASA/JPL-Caltech/University of Arizona.

RELATIONSHIPS TO OTHER NASA SCIENCE PROGRAMS

Planetary science activities at NASA are strongly coupled to the agency's other science programs: Astrophysics, Heliophysics, and to a limited extent, Earth Science divisions. Each is addressed below in more detail.

NASA's Astrophysics Division

The major science goals of the Astrophysics Division are to discover how the universe works, explore how the universe began and evolved, and to search planetary environments that may hold keys to life's origins or even might themselves sustain life.² Strong scientific synergy exists between the studies of extrasolar planets and Earth's planetary neighborhood. The former provides an immense variety of planetary systems in their structures and stages of evolution: known exoplanets now range from super-Jupiters to super-Earths. The latter affords the opportunity for detailed—often in situ—examination of the formation and evolution of one specific planetary system. A less obvious synergy is that space-based telescopes can support a host of user communities. The Hubble Space Telescope, for example, is a powerful observational tool for remote sensing of solar system objects, as well as a facility that probes to ultradeep corners of the cosmos. The same is true of other Astrophysics Division assets, such as the Spitzer Space Telescope, the Chandra X-ray Observatory, the Stratospheric Observatory for Infrared Astronomy, FUSE, the International Ultraviolet Explorer, WISE, IRAS, and others. The James Webb Space Telescope will also make significant contributions to planetary science. Chapter 10 contains details of the contributions ground- and space-based telescopes make to planetary science.

PREPUBLICATION COPY—SUBJECT TO FURTHER EDITORIAL CORRECTION

2-3



FIGURE 2.4 The plumes from the south pole of Saturn's tiny moon Enceladus. SOURCE: NASA/JPL/Space Science Institute.

NASA's Heliophysics Division

The Heliophysics Division sponsors research in solar and space physics, with particular emphasis on understanding the Sun and its interactions with Earth and other bodies in the solar system.³ This research also encompasses study of the particle and field environments of other solar system bodies and, in particular, comparative studies of planetary magnetospheres, ionospheres, and upper atmospheres.⁴ Such studies allow understanding of basic physical processes observed in the geospace environment to be applied to other solar system objects. This provides important opportunities to validate our understanding of these processes by observing their behavior in multiple planetary settings. Heliophysics activities also benefit planetary science by providing basic data on changes in solar insolation, the solar wind, and the interplanetary magnetic field, which can be connected to changes observed in planetary environments.

Studies of the particle and field environments of planetary bodies have been an integral component of NASA's planetary missions since the launch of Mariner 2 in 1962. Indeed, goals of flagship planetary missions such as the Voyagers, Galileo and Cassini are highly relevant to the heliophysics community. The first decadal survey of the heliophysics community gave relatively high priority to the Jupiter Polar Mission, an initiative designed to image the jovian aurorae, determine the electrodynamic properties of the Io flux tube, and identify magnetosphere-ionosphere coupling processes.⁵ The heliospheric decadal report also discussed a separate Io electrodynamics mission designed to conduct in situ measurements in the Io flux tube. Although the Io mission has not come to pass, instrumentation on PSD's Juno spacecraft will allow the main objectives of the proposed Jupiter Polar Mission to be achieved.⁶ Important synergy between heliophysics and planetary missions also exists in their instruments. Heliophysics instruments are usually relatively small with low power and data-downlink requirements, thereby offering heritage readily implemented on planetary missions.

PREPUBLICATION COPY—SUBJECT TO FURTHER EDITORIAL CORRECTION

NASA's Earth Science Division

Planetary science also has strong scientific links to SMD's Earth Science Division (ESD). The major scientific goal of this division are to advance Earth system science to meet the challenges of climate and environmental change.⁷ Advances in these areas will lead to a better understanding of Earth as a terrestrial planet and will obtain data essential to understanding the origin and evolution of a terrestrial planetary biosphere. To this end, SMD recently asked the community for input on connections and synergies between the research goals of ESD and PSD's Astrobiology program. Since the two programs share a common interest in the interactions between the biosphere and its planetary environment, research addressing the goals of one program has potential impact on achieving the goals of the other. SMD plans to use the community input to plan possible joint research topics, workshops, and other cooperative activities.

As Earth is the most intensely studied planet from space, there is synergy between the science and observational techniques developed for remote sensing of Earth. It is important to remember, however, that the instruments deployed on Earth-orbiting satellites may not be directly applicable for use in other planetary environments. The masses, volumes, power requirements and data downlink rates of instruments used to study Earth are typically incompatible with the more limited capacities of planetary spacecraft.

RELATIONSHIPS TO OTHER NSF PROGRAMS

As already mentioned, the principal source of planetary science funding within NSF is in its Division of Astronomical Sciences. However, other parts of NSF also make small but important contributions to planetary science.

NSF's Office of Polar Programs

The Office of Polar Programs (OPP) provides access to and logistical support for researchers working in Antarctica. Earth's south polar region is of direct relevance to planetary science because it is the world's most productive hunting ground for meteorites and because it contains environments relevant to studies of Mars and the icy satellites of the outer solar system. The meteorite collection program is a cooperative activity involving OPP, NASA, and the Smithsonian Institution; NSF and NASA currently support the fieldwork. Initial examination is done at the Astromaterials Acquisition and Curation Office at NASA's Johnson Space Center, and characterization and long-term curation are the responsibility of the Smithsonian's National Museum of Natural History.

Many features of the Antarctic environment are of direct relevance to planetary science, and to astrobiology in particular. Antarctica's Dry Valleys have many features that make them plausible analogs of a younger, warmer, wetter Mars. Similarly, the physical, chemical, and biological studies of Antarctica's perennially ice-covered lakes can advance understanding of the habitability of the oceans thought to exist beneath the icy surface of some of the satellites of the giant planets. Studies of these and other topics of planetary relevance are supported at a modest level by OPP's program of grants to individual investigators.



FIGURE 2.5 Scientists gathering meteorites in Antarctica, supported by NSF grants. SOURCE: Silvio Lorenzetti, ETH Zurich (Swiss Federal Institute of Technology Zurich)

NSF's Directorate for Geosciences

Grants awarded by the Atmospheric and Geospace Sciences Division provide modest support for research concerning planetary atmospheres and magnetospheres. Similarly, the Earth Science and Ocean Sciences divisions have supported studies of meteorites and ice-covered bodies. Such grants, though small compared with NASA's activities in similar areas, are important because they provide an important source of funding to researchers mostly to support graduate students and postdoctoral fellows. More importantly, they provide a key linkage between the relatively small community of planetary scientists and the much larger community of researchers studying Earth.

RELATIONSHIP TO NASA'S HUMAN EXPLORATION PROGRAM

Throughout the space age there have been periods of tension and cooperation between the human spaceflight program and the planetary science program. The greatest degree of cooperation between the two occurred during the Apollo era, when scientists were involved in landing site selection and the development of exploration goals, and also benefitted heavily from the lunar samples and other data returned from the six Apollo landings (Figure 2.5).

PREPUBLICATION COPY—SUBJECT TO FURTHER EDITORIAL CORRECTION

More recently, among the goals of the Vision for Space Exploration were the return of humans to the Moon and the development of new rockets and human spacecraft, designated Constellation. NASA's Exploration Systems Mission Directorate also funded the first of what was planned to be a series of lunar precursor missions known as the Lunar Reconnaissance Orbiter (LRO), and then the Lunar Crater Observation and Sensing Satellite (LCROSS). Both missions played a major role in helping to reinvigorate lunar science in the United States. However, the need for funds for the Constellation program led to cuts in the space science budget which also affected the planetary science program in significant ways, including cuts in technology development and other budgets, particularly the Mars program line.

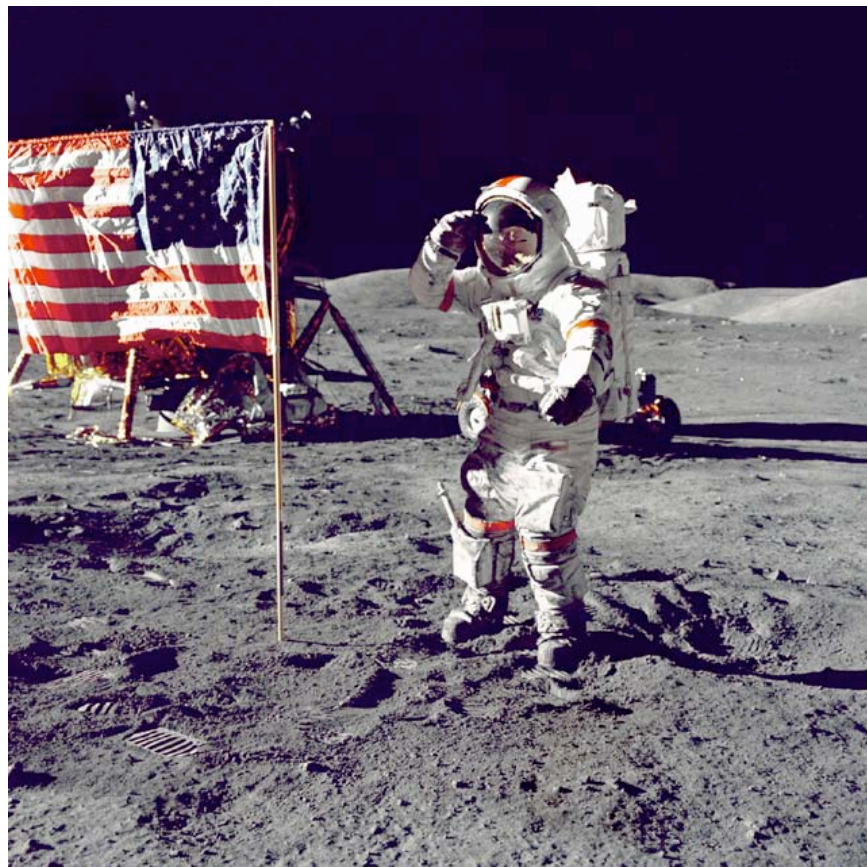

FIGURE 2.6 Apollo 17 astronaut Gene Cernan on the Moon's surface. The Apollo program was the last widespread cooperation between planetary scientists and the human spaceflight program, and the later Apollo missions provided a wealth of scientific data about the Moon. SOURCE: NASA.

In fall 2009, the U.S. Human Spaceflight Plans Committee—also known as the Augustine Committee—presented the results of its study of options for human spaceflight.⁸ In February 2010, the White House proposed NASA's FY2011 budget. From the planetary science perspective, the major impact of the proposed budget was the cancellation of plans for returning humans to the Moon, and the initiation of a series of robotic precursor missions to targets such as near-Earth objects (NEOs), the Moon and possibly the Martian moons Phobos and Deimos. At the time this decadal survey report was written the outcome of the congressional budgeting process was unclear, but it appeared likely that the robotic precursor program would not be funded to the extent it was originally proposed.

Human space exploration is undertaken to serve a variety of national and international interests. Indeed, the President, Congress, and the American public play a greater role in shaping the human-exploration agenda than the scientific community. Human exploration can provide important opportunities to advance science, but science is not the primary motivation. Measurements using remote sensing across the electromagnetic spectrum, atmospheric measurements, or determinations of particle flux density are by far best and most economically conducted using robotic spacecraft. But there is an important subset of planetary exploration that can benefit from human space flight. These are missions to the surfaces of solid bodies whose surface conditions are not too hostile for humans. For the foreseeable future, humans can only realistically explore the surfaces of the Moon, Mars, Phobos and Deimos, and some asteroids (Figure 2.8). The determination of which asteroids might be realistic human exploration targets will include considerations of gravity, safety, orbit, and richness of scientific return based on precursor measurements. It is likely that the subset of asteroids that are true potential targets is much smaller than the observed inventory of NEOs and should be the subject of a separate study. If the development of a heavy-lift launch vehicle proceeds as planned, the surface of the Moon or a near-earth asteroid is potentially accessible by humans sometime after 2022, but Mars remains a more distant goal for human exploration.

Precursor Robotic Missions

If the Apollo experience is an applicable guide, robotic missions to targets of interest will undoubtedly precede human landings. Human exploration precursor measurement objectives focus mainly on issues regarding health and safety and engineering practicalities, rather than science. While there are a number of examples where the interests intersect, for example finding a resource like water, the motivation and ultimate data applications of the two goals are typically quite different.

A positive example of synergy is the current Lunar Reconnaissance Orbiter mission (Figures 2.7 and 2.8). This project was conceived as a precursor for the human exploration program, but ultimately was executed in concert with the planetary science community. With one exception, a science peer-review process was followed for instrument selection. In fall 2010, after the end of the exploration phase of LRO's mission, responsibility for the spacecraft was turned over to PSD. Some 23 participating scientists were added to ensure that top-quality science is executed. By building on lessons learned from LRO, an effective approach to exploration-driven robotic precursor missions can be constructed.

Despite the positive recent example of LRO, the committee is concerned that, as demonstrated in the recent past, human spaceflight programs can cannibalize space science programs. The committee agrees with the statement by the Human Spaceflight Plans Committee report that “it is essential that budgetary firewalls be built between these two broad categories of activity. Without such a mechanism, turmoil is assured and program balance endangered.”⁹

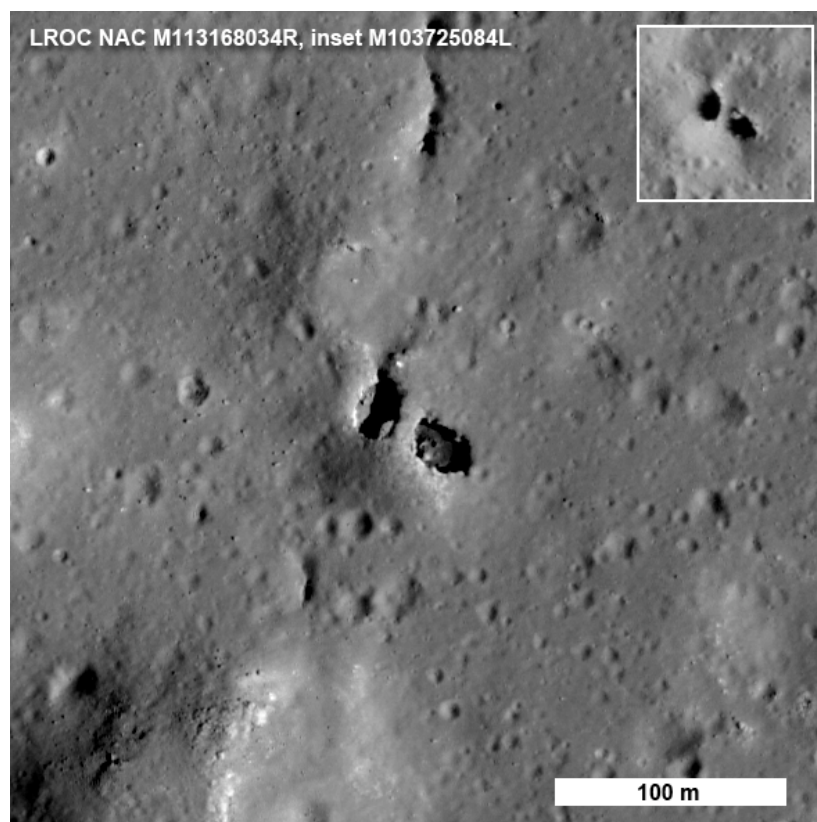

FIGURE 2.6 A natural bridge on the Moon photographed by the Lunar Reconnaissance Orbiter. SOURCE: NASA Goddard Space Flight Center/Arizona State University.

Within the planetary science program there have been and will likely continue to be peer reviewed missions selected that are destined for likely targets of human exploration. Two relevant examples are the New Frontiers projects MoonRise—a lunar South Pole-Aitkin Basin sample return mission—and OSIRIS-REx—an asteroid sample return mission—now under study for eventual down selection to one mission in 2011. The committee believes that **it is vital to maintain the science focus of such peer-reviewed missions and not to incorporate human exploration requirements after the mission has been selected and development has begun.** If the data gathered by such missions have utility for human exploration, the analysis should be paid for by the human exploration program and firewalled from the science budget. Similarly, if the human exploration program proposes a precursor mission (like LRO) and there is an opportunity for conducting science at the destination, science should be very cautious about directly or indirectly imposing mission-defining requirements, and be willing to pay for any such requirements.

The need for caution does not rule out the possibility of carefully crafted collaborations, however. It may be possible, for example, to put science-focused instrumentation on some of these missions, or for science missions to certain targets to carry ESMD-funded instrumentation. Also, missions designed to prepare for future human exploration can be “re-purposed” to address scientific questions once their primary mission has been completed, as was recently done for LRO.

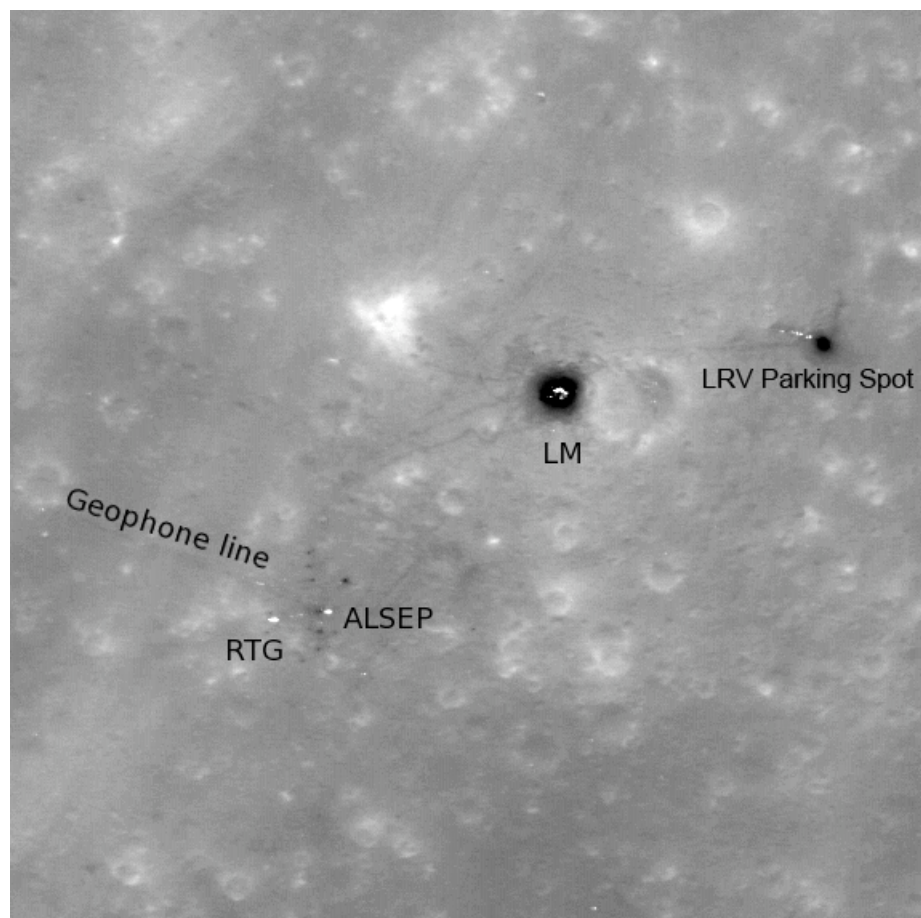

FIGURE 2.8 The Apollo 16 landing site photographed by the Lunar Reconnaissance Orbiter. SOURCE: NASA Goddard Space Flight Center/Arizona State University.

Human Landed Missions and Science

In popular culture, the term “robot” conjures up a fully autonomous, reasoning, anthropomorphic creature such as envisioned in the Issac Asimov’s *I Robot*. However, in modern industrial and scientific applications, robots are best at the “three Ds”: dull, dirty or dangerous work. Robotic systems can be designed to operate in extreme environments deadly to humans, but they are programmed and at times teleoperated by humans. Currently, even the most sophisticated robotic spacecraft have limited intellectual and physical capabilities. Rovers and orbiters only do what they are told and are incapable of completely independent autonomous reasoning. By comparison, human explorers on other worlds are intellectually flexible and adaptable to different situations, as demonstrated by the Apollo sample collection and the Hubble on-orbit servicing and repair. Humans develop and communicate ideas, not just data. Human adaptability and capability in an unstructured environment far surpasses that of robots, and will for the foreseeable future. Conversely, the cost of human exploration is perhaps 10 to 100 times that of robots, primarily because of the human needs for life support, sleeping quarters, eating, and safety.

What should be the roles of humans and robots to meet the goals of planetary exploration? For decades NRC studies of human spaceflight have concluded that there is no a priori scientific requirement for the human exploration of the Moon and Mars.^{10,11} In reviewing the past studies and current planetary science goals, the committee reached the same conclusion as past NRC studies that **most of the key scientific lunar and NEO exploration goals can be achieved robotically**. Scientifically useful

PREPUBLICATION COPY—SUBJECT TO FURTHER EDITORIAL CORRECTION

investigations should still be developed to augment human missions to the Moon or NEOs. The committee **urges the human exploration program to examine this decadal survey and identify—in close coordination and negotiation with the SMD—objectives where human-tended science may advance our fundamental knowledge.** Finding and collecting the most scientifically valuable samples for return to Earth may become, as it was in the Apollo program, the single most important function of a human explorer on the Moon or an asteroid.

For several decades, the NRC has conducted studies of the scientific utility of human explorers or human-robotic exploration teams for exploring the solar system. Invariably, the target of greatest interest has been Mars. The scientific rationale cited has largely focused on answering questions relating to the search for past or present biological activity. Based on the importance of questions relating to life, the committee concluded that for the more distant future, human explorers with robotic assistance may contribute more to the scientific exploration of Mars than they can to any other body in the solar system.^{12,13} Robotic missions to Mars, either purely for science or as precursors to a human landing, can provide the basic scientific data and lay the groundwork for human presence. Humans will then take exploration to the next steps by making sense of the complex martian environment, rapidly making on-the-spot decisions to choose the right spots for sampling, performing the best experiments, and then interpreting the results and following up opportunistically.

Summary

For decades, planetary science has adopted a graduated, step-wise approach to exploration, from initial fly-by to orbital reconnaissance, followed by in situ investigation and ultimately a return of samples to laboratories for exhaustive examination. While humans are not required to return samples from the Moon, asteroids, or Mars, if humans are going to visit these bodies, collecting and returning high-quality samples is one of the most scientifically important things they can do.

The robotic and human exploration of space should be synergistic, both at the program level (e.g., science probes to Mars and humans to Mars) and at the operational level, e.g., humans with robotic assistants. Both drive the development of new technologies to accomplish objectives at new destinations. However, this effort must proceed without burdening the space science budget or influencing its process of peer-based selection of science missions. Conversely, NASA can proceed to develop the robotic component of its human exploration program. Through this cooperative and collaborative effort, NASA can accomplish the best for both programs.

INTERNATIONAL COOPERATION IN PLANETARY SCIENCE

Planetary exploration is an increasingly international endeavor, with the United States, Russia, Europe, Japan, Canada, China, and India independently or collaboratively mounting major planetary missions. As budgets for space programs come under increasing pressure and the complexity of the missions grows, international cooperation becomes an enabling component. New alliances and mechanisms to cooperate are emerging, enabling partners to improve national capabilities, share costs, build common interests, and eliminate duplication of effort. But international agreements and plans for cooperation must be crafted with care, for they also can carry risks. The management of international missions adds layers of complexity to their technical specification, management, and implementation. Different space agencies use different planning horizons, funding approaches, selection processes, and data dissemination policies. Nonetheless, international cooperation remains a crucial element of the planetary program; it may be the only realistic option to undertake some of the most ambitious and scientifically rewarding missions.

Mechanisms and Recent Examples of Cooperation

Flagship missions afford the greatest potential for NASA and other space agencies to unite resources and meet difficult challenges. The joint NASA-ESA (European Space Agency) Galileo and Cassini-Huygens missions to explore the jovian and saturnian systems are superb examples of international cooperation of this scale (Figures 2.8 and 2.9). Flagship missions like Galileo and Cassini are complex to manage and implement as they involve integrating major spacecraft components supplied by different nations (engines, antennas, probes, dual spacecraft) into a single flight system. Still, to minimize the high fractional costs of launch and orbital insertion or landing, this architecture can be the most cost-effective one. Recently NASA and ESA have been considering joint missions of this integrated form to undertake Mars sample return and to explore Titan simultaneously from orbit and in situ.

A less complex but still powerful approach involves joint observations from multiple spacecraft each delivered to a planetary target by an individual space agency, as was used in the reconnaissance of Comet Halley. Discussion has been ongoing of a coordinated program of this form to explore the Jupiter system, wherein NASA would contribute a Europa orbiter (recommended by the NRC's first planetary decadal survey¹⁴) and ESA would contribute a Ganymede orbiter (see Chapter 7 and 8). Likewise an International Lunar Network has been under consideration wherein NASA might provide two or more nodes while other nations would provide additional nodes.



FIGURE 2.9 A human mission to an asteroid is an example of a potential overlap between planetary science interests and human exploration interests. SOURCE: Courtesy of Josh B Hopkins, Lockheed Martin.



FIGURE 2.10 The surface of Titan as seen by the Huygens lander. Cassini-Huygens is an example of successful international cooperation in planetary exploration. SOURCE: ESA/NASA/JPL/University of Arizona.

A common collaborative arrangement is the provision of resources by foreign partners to NASA-led missions (and vice versa); these resources might include, for example, payload instruments, other key flight elements, or team members. NASA contributions to foreign missions have been funded by programs such as the past “Mission of Opportunity” or the present SALMON (Stand-Alone Missions of Opportunity). For example, India’s Chandrayaan-1 lunar mission carried a U.S. instrument and NASA’s Lunar Reconnaissance Orbiter includes a Russian instrument. NASA’s Mars Exploration Rover and Phoenix missions included instruments and team members from Germany, Denmark, and Canada. Canada, France, Spain and Russia are contributing elements of the Mars Science Laboratory payload, and Italy and the United Kingdom have contributed to the Mars Reconnaissance Orbiter mission. NASA’s second New Frontiers mission Juno will carry an auroral instrument provided by the Italian Space Agency. NASA is providing two instruments to ESA’s Rosetta comet mission; European nations are making multiple contributions to the payload for Dawn, NASA’s mission to Vesta and Ceres and to NASA’s Mars Science Laboratory. These collaborations dramatically expand mission capabilities, and are crucial to developing a strong and most effective international scientific community. Among cooperative efforts now underway is NASA’s contribution to the instrument payload for the ESA-led Mars Trace Gas Orbiter, part of an evolving long-term cooperation between NASA and ESA in Mars exploration.

PREPUBLICATION COPY—SUBJECT TO FURTHER EDITORIAL CORRECTION

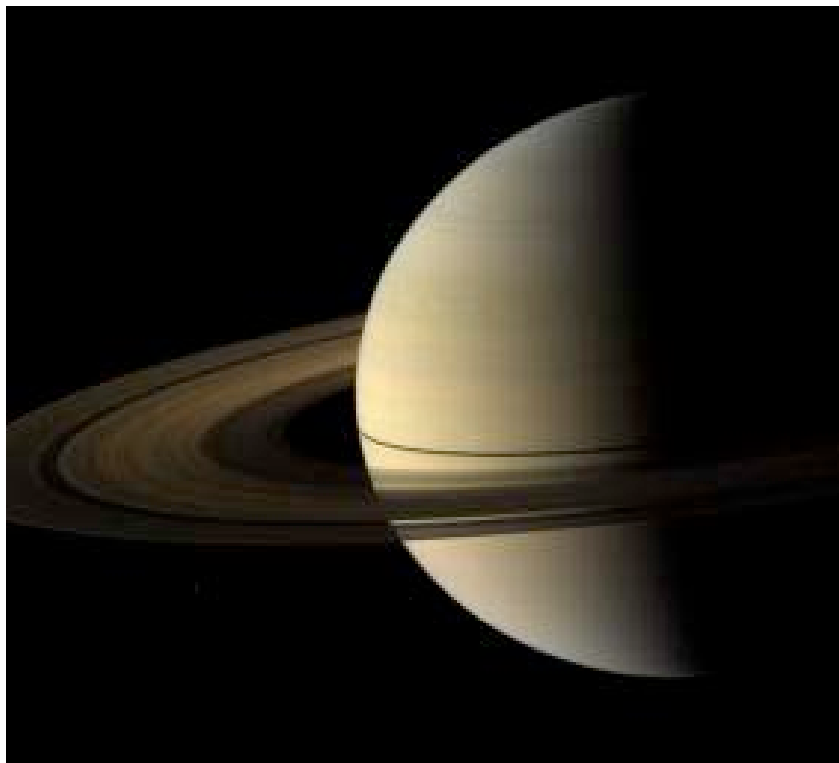

FIGURE 2.11 Saturn and its rings imaged by Cassini. SOURCE: NASA/JPL/Space Science Institute.

Guidelines for International Cooperation

Notwithstanding the enormous benefits, both societal and scientific, that international cooperation affords, such agreements should not be entered into without due consideration. Because of more complicated aspects of agreement on technical specifications, management by multiple interests, implementation and integration procedures, and the impact of the International Trafficking in Arms Regulations, cost and schedule growth can occur. In part, this is because U.S. and international partnering agencies can have different goals for the endeavor, use different fiscal timelines and commitment schedules, and employ incongruent proposal requirements and selection processes. Although NASA and NSF should embrace the opportunities for collaboration with foreign partners, they must do so with full understanding of the potential risks and how they can be managed. The committee draws from the general principles and guidelines for international cooperation, laid out in past studies, in particular the joint report of the Space Studies Board and the European Space Science Committee entitled *U.S.-European Collaboration In Space Science*.¹⁵ Following examination of a series of case studies examining the positive and negative aspects of past transatlantic cooperative space-science ventures, the committee laid out eight essential ingredients that an agreement to engage in an international collaboration must contain; they are as follows:

1. *Scientific support through peer review that affirms the scientific integrity, value, requirements, and benefits of a cooperative mission;*
2. *An historical foundation built on an existing international community, partnership, and shared scientific experiences;*

- 3 *Shared objectives that incorporate the interests of scientists, engineers, and managers in common and communicated goals;*
- 4 *Clearly defined responsibilities and roles for cooperative partners, including scientists, engineers, and mission managers;*
- 5 *An agreed-upon process for data calibration, validation, access, and distribution;*
- 6 *A sense of partnership recognizing the unique contributions of each participant;*
- 7 *Beneficial characteristics of cooperation; and*
- 8 *Recognition of the importance of reviews for cooperative activities in the conceptual, developmental, active, or extended mission phases—particularly for foreseen and upcoming large missions.*

Summary

Despite the negative consequences that may potentially accrue if cooperative activities are not planned and conducted in a manner consistent with the eight principles listed above, the committee strongly supports international efforts and encourages the expansion of international cooperation on planetary missions to accelerate technology maturation and share costs. International cooperation generally provides resilience to long-term space programs and allows optimal use of an international workforce and expertise. Multiple international space powers have now mastered major technological challenges required to explore the solar system. As such, international cooperation should remain a key element of the nation's planetary exploration program. An internationally engaged program of solar system program can unite stakeholders worldwide and lay the roadmap for humans to venture into space in the next phases of exploration.



FIGURE 2.12 The International Year of Astronomy ended with a lunar eclipse. SOURCE: Courtesy of Jean Paul Roux.

REFERENCES

1. Science Mission Directorate, *2010 Science Plan For NASA's Science Mission Directorate*, NASA, Washington, D.C., 2010, pp. 74-75.
2. Science Mission Directorate, *2010 Science Plan For NASA's Science Mission Directorate*, NASA, Washington, D.C., 2010, pp. 74-75.
3. Science Mission Directorate, *2010 Science Plan For NASA's Science Mission Directorate*, NASA, Washington, D.C., 2010, pp. 74-75.
4. See, for example, National Research Council, *The Sun to the Earth—and Beyond: Panel Reports*, The National Academies Press, 2003, pp. 73-87.
5. National Research Council, *The Sun to the Earth—and Beyond: A Decadal Research Strategy in Solar and Space Physics*, The National Academies Press, 2003, p. 6.
6. National Research Council, *A Performance Assessment of NASA's Heliophysics Program*, The National Academies Press, 2009, pp. 5 and 32.
7. Science Mission Directorate, *2010 Science Plan For NASA's Science Mission Directorate*, NASA, Washington, D.C., 2010, pp. 74-75.
8. Executive Office of the President, *Review of U.S. Human Spaceflight Committee, Seeking a Human Spaceflight Program Worthy of a Great Nation*, Washington, D.C., 2009.
9. Executive Office of the President *Review of U.S. Human Spaceflight Committee, Seeking a Human Spaceflight Program Worthy of a Great Nation*, Washington, D.C., 2009.
10. National Research Council, *The Human Exploration of Space*, National Academy Press, Washington, D.C., 1997.
11. National Research Council, *Safe on Mars: Precursor Measurements Necessary to Support Human Operations on the Martian Surface*, National Academy Press, Washington, D.C., 2002.
12. National Research Council, *The Human Exploration of Space*, National Academy Press, Washington, D.C., 1997.
13. National Research Council, *Safe on Mars: Precursor Measurements Necessary to Support Human Operations on the Martian Surface*, National Academy Press, Washington, D.C., 2002.
14. National Research Council, *New Frontiers in the Solar System: An Integrated Exploration Strategy*, The National Academies Press, Washington, D.C., 2003.
15. National Research Council and European Science Foundation, *U.S.-European Collaboration In Space Science*, National Academy Press, Washington, D.C., 1998, pp. 102-103.

3

Priority Questions in Planetary Science for the Next Decade**CROSCUTTING THEMES**

Crosscutting themes in planetary science deal with issues of profound importance that have been pondered by scientists and non-scientists alike for centuries. They cannot be fully addressed by a single spacecraft mission and will likely not be completely addressed in this decade or the next. The themes are not new; their like can be found in past reports.^{1,2} They explain why planetary science is an important undertaking, worthy of public support. The committee identifies three themes of particular interest for the next decade; these are stimulated by recent advances in planetary science as well as by their fundamental nature.

- Building New Worlds—understanding solar system beginnings
- Planetary Habitats—searching for the requirements for life
- Workings of Solar Systems—revealing planetary processes through time

Each theme brings its own set of questions, based on current understanding of the underlying scientific issues. Each question represents a distillation of major areas of research in planetary science and the questions themselves are sometimes crosscutting. Each question points to one or more solar system bodies that may hold clues or other vital information necessary for their resolution. Subsequent chapters (4-8) further explore these questions, dissecting them to identify the specific opportunities best addressed in the coming decade by large, medium, and small spacecraft missions, as well as by other space- and ground-based research activities. As outlined in the sections that follow, in situ analyses and ultimately sample return will be required to achieve major breakthroughs in addressing many of these questions.

PRIORITY QUESTIONS**Building New Worlds**

A little over 4.5 billion years ago, a small clump of gas and dust within a giant molecular cloud began to collapse, perhaps triggered by the shockwave from a nearby supernova. The clump was mainly hydrogen and helium gas, slightly enriched with a percent or two of heavier elements—remnants of older generations of stars. Some 100,000 years later, gravity and inertia had shaped the clump into a flattened, swirling disk of material with a nascent star at its core. After another 50 million years or so, the center of this “protostar” was hot enough that hydrogen fusion began: our Sun was born. Within the disk of debris whirling around the infant star, planet formation began. Gases condensed onto dust and ices, and the ice and dust began to accrete and grow into the precursors of planets: planetesimals. These collided with each other, growing ever larger and more complex. The end result was the diverse suite of planetary bodies seen in the solar system today; planetary systems around other stars are beginning to display even more diversity. Three major questions emerge from this story of the formation and evolution of our solar system:

PREPUBLICATION COPY—SUBJECT TO FURTHER EDITORIAL CORRECTION

- What were the initial stages, conditions and processes of solar system formation and the nature of the interstellar matter that was incorporated?
- How did the giant planets and their satellite systems accrete, and is there evidence that they migrated to new orbital positions?
- What governed the accretion, supply of water, chemistry, and internal differentiation of the inner planets and the evolution of their atmospheres, and what roles did bombardment by large projectiles play?

Planetary Habitats

As the solar system formed, at least one planetary body experienced a remarkable event: life began, proliferated, and developed to the point where humankind now ponders its own origins. Was the origin of life a unique event or was it repeated elsewhere in the solar system or in extrasolar planetary systems; what conditions are required? The fundamental question is broader than whether or not life exists or existed on one particular planetary body like Mars, Europa, or elsewhere. Rather, the question is how life came to exist at all? Although the mechanisms by which life originated are as yet unknown, the processes likely involve the simultaneous presence of organic compounds, trace elements, water, and sources of energy. Demonstrating that some planetary environments are abodes for life will elucidate the origins of Earth's life. To explore this, the following questions about past and present planetary environments that could foster life need to be addressed:

- What were the primordial sources of organic matter, and where does organic synthesis continue today?
- Did Mars or Venus host ancient aqueous environments conducive to early life, and is there evidence that life emerged?
- Beyond Earth, are there today, elsewhere in the solar system habitats with necessary conditions, organic matter, water, energy, and nutrients to sustain life, and do organisms live there now?

Workings of Solar Systems

The solar system displays a rich panoply of planetary environments. The known planetary systems around other stars are beginning to display an even greater range of planetary architectures. Comprehending this diversity requires a detailed understanding of the physical and chemical properties and processes that shape planetary interiors, surfaces, atmospheres, rings, and magnetospheres. Relevant interior processes include, for example, chemical differentiation, core formation, and heat transfer throughout planetary history. Impact cratering, tectonism, and volcanism are important geological processes that have shaped planetary surfaces. Planetary atmospheres hold a record of the volatile evolution of a planet and the interactions among surfaces, weather, and climate. Equally important is to understand the intricate balance of a planet with its environment, an environment crafted and maintained by the host star that dominates the planetary system. Host stars, such as the Sun, have their own life cycle much as planets do, and the changes during that cycle play a profound role in modifying the attendant planets. A variety of critical questions arise about how planetary systems function:

- How do the giant planets serve as laboratories to understand Earth, the solar system, and extrasolar planetary systems?
- What solar system bodies endanger and what mechanisms shield Earth's biosphere?
- Can understanding the roles of physics, chemistry, geology, and dynamics in driving planetary atmospheres lead to a better understanding of climate change on Earth?

PREPUBLICATION COPY—SUBJECT TO FURTHER EDITORIAL CORRECTION

- How have the myriad chemical and physical processes that shaped the solar system operated, interacted, and evolved over time?

Table 3.1 summarizes the questions and destinations for the next decade that are discussed more fully in the rest of this chapter; they are examined in much greater detail in Chapters 4-8. Table 9.4 in Chapter 9 links these questions and destinations to the committee’s recommended missions.

TABLE 3.1 The Key Questions and Planetary Destinations to Address Them

Crosscutting Themes	Priority Questions	Key Bodies to Study
Building New Worlds	1. What were the initial stages, conditions and processes of solar system formation and the nature of the interstellar matter that was incorporated?	Comets, Asteroids, Trojans, Kuiper belt objects (See Chapter 4)
	2. How did the giant planets and their satellite systems accrete, and is there evidence that they migrated to new orbital positions?	Enceladus, Europa, Io, Ganymede, Jupiter, Saturn, Uranus, Neptune, Kuiper belt objects, Titan, Rings (See Chapters 4, 7 & 8)
	3. What governed the accretion, supply of water, chemistry, and internal differentiation of the inner planets and the evolution of their atmospheres, and what roles did bombardment by large projectiles play?	Mars, Moon, Trojans, Venus, Asteroids, Comets (See Chapters 4, 5 & 6)
Planetary Habitats	4. What were the primordial sources of organic matter, and where does organic synthesis continue today?	Comets, Asteroids, Trojans, Kuiper belt objects, Uranian satellites, Enceladus, Europa, Mars, Titan (See Chapters 4, 5, 6 & 8)
	5. Did Mars or Venus host ancient aqueous environments conducive to early life, and is there evidence that life emerged?	Mars and Venus (See Chapters 5 & 6)
	6. Beyond Earth, are there modern habitats elsewhere in the solar system with necessary conditions, organic matter, water, energy, and nutrients to sustain life, and do organisms live there now?	Enceladus, Europa, Mars, Titan (See Chapters 6 & 8)
Workings of Solar Systems	7. How do the giant planets serve as laboratories to understand Earth, the solar system and extrasolar planetary systems?	Jupiter, Neptune, Saturn, Uranus (See Chapter 7)
	8. What solar system bodies endanger and what mechanisms shield Earth’s biosphere?	Near-Earth objects, the Moon, Comets, Jupiter (See Chapters 4, 5 & 7)
	9. Can understanding the roles of physics, chemistry, geology, and dynamics in driving planetary atmospheres lead to a better understanding of climate change on Earth?	Mars, Jupiter, Neptune, Saturn, Titan, Uranus, Venus (See Chapters 5, 6 & 8)
	10. How have the myriad chemical and physical processes that shaped the solar system operated, interacted, and evolved over time?	All solar system destinations. (See Chapters 4, 5, 6, 7 & 8)

BUILDING NEW WORLDS: UNDERSTANDING SOLAR SYSTEM BEGINNINGS

What Were the Initial Stages and Conditions and Processes of Solar System Formation and the Nature of the Interstellar Matter that Was Incorporated?

A nearby supernova explosion may have initially triggered the collapse of the local molecular cloud and thereby the onset of solar system formation.³ Many primitive bodies—asteroids, comets, meteorites, Kuiper belt objects, Trojan asteroids, and bodies in the distant Oort cloud—still contain intact records of this very early period. Examination of their minerals and their isotopic and molecular chemistry can reveal the physical conditions under which they formed and provide our best view into this earliest chapter of solar system formation. In fact, we may see isotopic evidence of such a supernova explosion in ancient meteorite samples.⁴ The least-processed of the primitive meteorite samples preserve tiny presolar grains, whose isotopic compositions reflect the nucleosynthetic processes in stars and supernovae that preceded solar system formation.⁵ These presolar stellar remnants provided key ingredients (e.g. metals and silicates) for the accretion of planets.

In the last decade major progress has been made in linking the compositions of presolar grains in chondritic meteorites to the specific stellar environments where they are formed.⁶ Unexpectedly, presolar grains were in low abundance in comet samples returned by the Stardust mission, signaling our limited understanding as to how and where presolar grains were incorporated into the solar nebula.⁷ Recent studies of organic matter in these materials are starting to reveal how carbon-based molecules formed in interstellar space are further processed and incorporated. Most of the presolar grains recognized so far are carbon (diamond and graphite) or carbides;⁸ important questions remain as to the abundance of presolar silicates and oxides and how the compositions of presolar grains and organic molecules differ among comets.

After the Sun formed, the solar nebula gradually began to coalesce and form clumps that, in turn, accreted into planetesimals. In the inner solar system where conditions were hotter, primitive asteroids and meteorites record early events and processes in the solar nebula whereby interstellar solids melted, evaporated, and condensed to form new compounds. Farther out, beyond the “snow line”, it was cooler and volatiles condensed as ices; here the giant planets and their satellite systems began to form. In this region and extending farther out where temperatures were extremely low minimizing chemical processing, the parent objects of comets formed. They retain the most pristine records of the initial chemistry of the outer parts of the solar nebula. The size distributions of objects in the Kuiper belt reveal the nature of accretion in the outer region that was arrested early, ceasing their growth.^{9,10} Mixing of materials between nebular regions is clearly shown by the diverse components in the Stardust comet samples.¹¹ It also now appears that some differentiated asteroids formed earlier than the primitive chondrites, showing that the accretional sequences were far more complex than once thought.¹²

Over the next decade important breakthroughs in our understanding of presolar materials and early nebular processes will certainly come from applying ever advancing analytical techniques in the analysis of meteorites, interplanetary dust, and Stardust samples. However, greater potential to achieve major steps in our understanding of presolar and nebular cosmochemistry would come from the analysis of samples returned directly from the surfaces of comets. Stardust samples have dramatically expanded our knowledge of presolar sources and nebular processes. Eventually, the greatest scientific breakthroughs in addressing these questions will come from returning surface samples whose volatiles have been cryogenically preserved.

How Did the Giant Planets and Their Satellite Systems Accrete and Is There Evidence that They Migrated to New Orbital Positions?

The terrestrial planets grew only to relatively small sizes owing to the scarcity of metal and silicate grains in the inner solar nebula. However, the ices that condensed from the nebular gas beyond the snow line were more abundant. We witness similar processes ongoing in exoplanetary systems. Thus, the planetary embryos of the giant planets grew rapidly in the first few million years until they became massive enough to capture directly the most abundant elements in the solar nebula, hydrogen and helium. Jupiter's enormous size is very likely correlated to its position just outside the snow line: water vapor driven out across this boundary would rapidly condense and pile up; solid particles orbiting outside the snow line experienced a low pressure zone and sped up owing to the reduced drag, thus slowing their migration inward. In this way, Jupiter's feeding zone was extremely well supplied.

The regular satellites of Jupiter, Saturn, and Uranus orbit in their equatorial planes, suggesting that they formed in subnebular disks like miniature solar systems.¹³ Neptune's coplanar satellite system was likely destroyed by the capture of Triton, its large retrograde satellite, probably a renegade Kuiper belt object. Too small to capture much gas gravitationally, the satellites accreted mainly from icy and rocky solids. They might have captured gases in clathrates (i.e., water-ice cages) or in amorphous ices. If their icy solids came directly from the solar nebula, they would retain nebular volatile abundances. Cassini-Huygens data suggest this to be the likely case for Saturn's moons and Titan in particular.^{14,15} If they were formed in the gas-giant subnebulae, dependent on the radial temperature profile, some regions would be hot enough to vaporize ices, resetting isotopic thermometers and phases before they re-condensed. Such subnebula processing is speculated for Jupiter's regular satellites, but crucial measurements are lacking. Untangling nebula versus subnebula processes requires knowing the internal structures of the satellites, volatile ice abundances, stable isotope ratios of carbon, hydrogen, oxygen, and nitrogen, and abundances of the noble gases. Addressing these key questions will require precise geophysical, remote sensing, and in situ measurements across the outer planet satellites of their internal structures and their compositions from their plumes, sputtered atmospheres, co-orbiting tori, and surfaces.

Many unknowns remain as to how the outer planets formed out of the solar nebula and if and when they migrated into different orbits. This is also an important question with regard to exoplanets. The Galileo probe sent into Jupiter's atmosphere showed quite surprisingly that the noble gases argon, krypton, and xenon are much more abundant there than in the Sun. Suggested explanations for their concentration include: condensation of noble gases on extremely cold nebular solids, capture of clathrate hydrates, evaporation of the protoplanetary disk before Jupiter formed, and outgassing of noble gases from the deep interior enriching them in the atmosphere.¹⁶ Each of these hypotheses leads to testable predictions for noble gas abundances in the other giant planets—definitive answers will require in situ probe measurements—critical data that we lack for Saturn, Uranus, and Neptune.

Resolving a second major puzzle also mandates probe measurements. Solar system models that placed the formation of Uranus and Neptune at their current positions were unable to produce cores of the ice-giants rapidly enough. Modelers concluded that the giant planets must have migrated to new orbits since their formation. It is now thought that during the first half billion years of the solar system, Uranus and Neptune orbited in the region much closer to the Sun; it is even possible that Neptune was inside Uranus's orbit.^{17,18} The models suggest that at about 4 billion years ago Saturn and Jupiter entered a 2:1 orbital resonance, increasing Saturn's eccentricity and thereby driving Uranus and Neptune out into the Kuiper belt that in turn was driven out to its current location.

Many variations of such scenarios have been hypothesized. However, key evidence is lacking, and a complete understanding of formation and migration of the four planets that account for 99 percent of the mass in the solar system awaits key measurements at Saturn, Uranus and Neptune. To distinguish between the array of theorized scenarios for formation and migration of the giant planets and their satellite systems, we need to know detailed composition—deuterium/hydrogen and hydrogen/helium ratios, other isotopic ratios, and information about noble gases that can only be obtained in situ from giant-planet atmospheric probes. To address these questions, detailed in situ measurements as acquired

PREPUBLICATION COPY—SUBJECT TO FURTHER EDITORIAL CORRECTION

by the Galileo probe of the compositions of the atmospheres of Saturn, Uranus, and Neptune are of high priority.

What Governed the Accretion, Supply of Water, Chemistry, and Internal Differentiation of the Inner Planets and the Evolution of their Atmospheres, and What Roles did Bombardment by Large Projectiles Play?

We now think that the presolar silicate and metallic materials in the hot inner solar nebula accreted quite early, gathering into on the order of a hundred Moon-to-Mars sized planetesimals.¹⁹ Owing to the scarcity of such material in the nebula these protoplanets would have ceased growing very early, approximately when Sun's T Tauri phase began. Over the next ~100 million years the terrestrial planets grew from the collisional merging of these objects;²⁰ the Moon is hypothesized to have formed in this period by a glancing collision of a Mars-sized planetesimal with Earth. If Jupiter and Saturn entered a 2:1 orbital resonance ~4 billion years ago, they triggered an orbital reshuffling and bombardment that reshaped the inner solar system.²¹ As Uranus and Neptune surged outward, Kuiper belt objects would have been scattered—many, shed into the inner solar system, could have delivered water and other volatiles to the terrestrial planets as a late veneer.²² Most objects in the asteroid belt were also scattered, some inward, delivering more water to the inner planets. These two impacting populations are hypothesized to have caused the late heavy bombardment that had been suggested in the lunar cratering record; its timing may be linked to the emergence of life on Earth.^{23,24}

Because asteroids and Kuiper belt objects were important ingredients in the recipe for the terrestrial planets, they retain many clues to early evolution of the inner planets. We currently know very little about the composition and physical characteristics of Trojans and Centaurs. Like Centaurs, Trojans may come from the Kuiper belt but may have been formed closer in near Jupiter. Obtaining information by direct spacecraft observations will help constrain existing models of the origins of these bodies. Study of these objects is important as they may contain key information about the parent materials that accreted in the inner solar system. An important scientific goal for this decade is to begin the scientific exploration of the Trojan asteroids.

The distribution of bodies in the Kuiper belt may provide key evidence about the orbital migration of the giant planets.²⁵ Measuring the time of formation of individual components that comprise comets will constrain the evolution of objects beyond the orbit of Neptune. Refractory inclusions in the Stardust sample from comet Wild 2 suggest that inner solar system material was mixed out into the Kuiper belt zone.²⁶ Determining the deuterium/hydrogen and other crucial isotopic ratios in multiple comets from samples of their nuclei could elucidate major questions about the roles they played in delivering water and other volatiles to the inner solar system and in particular to early Earth.

Soon after the terrestrial planets formed, their interiors differentiated into rocky crusts and mantles and metallic cores; they continued to dissipate internal energy through mantle convection, magnetic field generation, and magmatism. Earth, the Moon, and Mars all show isotopic evidence that they had differentiated only 10-50 million years after formation; this was very likely the case for Venus and Mercury as well.²⁷ To understand the subsequent evolution of these bodies we need to know their bulk chemistries and internal structures. Geophysical exploration of the internal structure of the Moon and Mars with a global seismic network remains an achievable goal of exceptional scientific importance. Lunar samples indicate that the Moon formed hot with a deep magma ocean; magma oceans may have been common to all terrestrial planets. Analysis of ancient samples excavated from the deep interior during formation of the Moon's South Pole Aiken Basin could yield deep insights into the earliest stages of Earth-Moon formation and evolution, opening records that have vanished from Earth.

Major questions remain regarding how and when water and other volatiles were delivered to Earth. What fraction of Earth's volatile inventory was delivered directly by planetesimals during accretion and later outgassed to the surface during differentiation and subsequent volcanism? What fraction was acquired as a late veneer from impact of comets and volatile-rich asteroids during the late

PREPUBLICATION COPY—SUBJECT TO FURTHER EDITORIAL CORRECTION

heavy bombardment? Clues to address these questions could remain locked in chemical signatures at the surfaces and in atmospheres of Earth's neighbors.

Venus and Mars formed at orbital radii that bracket Earth's. The isotopic, elemental, molecular, and mineralogical records retained in their surfaces and atmospheres can be studied to reveal radial gradients in the accreting sources of volatiles, the early transport of volatiles into the inner solar system by collisional and gravitational scattering and mixing, and the relative importance of asteroidal and cometary sources in delivery of a late arriving veneer. For example, Galileo and Venus Express results show that Venus's highlands may be more silicic, suggesting early eruption of hydrous magmas.^{28,29} The critical questions of volatile origin for Venus can best be addressed by in situ measurement of the noble gases and molecular and isotopic chemistry in the atmosphere, as well as the geochemistry and mineralogy of its surface. We have gleaned nearly all that can be learned from martian meteorites, likely a highly biased sample based on their young radiometric ages compared to crater counting ages of the martian surface.³⁰ The origin and evolution of volatiles on Mars appears to have a complex, many-staged history. While we have gleaned significant information from martian meteorites and current in situ missions on the chemistry of the atmosphere as well as the geochemistry and mineralogy of the surface, many newly identified geochemical environments have not been observed in situ, and significant advances will be obtained through the return of martian samples, which can be studied with the most sophisticated instruments using highly diverse analytical techniques not possible with a single surface mission.

PLANETARY HABITATS: SEARCHING FOR THE REQUIREMENTS OF LIFE

What Were the Primordial Sources of Organic Matter, and Where Does Organic Synthesis Continue Today?

Organic molecules—crucial to life—are widespread across the solar system. Major progress has been made in the last decade in tracing their origins from the most primitive presolar sources to the active environments and the physical and chemical processes by which they are being created and destroyed today. Tracing their origins and evolution traces ours, for without the complement of organics delivered to or chemically synthesized on the early Earth, life here would not exist.

We are beginning to understand how carbon-based molecules were formed in interstellar space and later combined into other complex molecules in the solar nebula and in planetesimals. Satellites of the outer solar system are rich in organics. The complex array of organic molecules and active chemistry in Titan's atmosphere and at its surface afford an invaluable laboratory to understand prebiotic chemical processing on a planetary scale.³¹ Organics in the polar jets of Enceladus signal that the icy satellites harbor organic molecules and processes in their interiors—key indicators if life were ever to emerge in such subsurface environments.³² Evidence for methane, one of the simplest organic compounds, has been reported in the martian atmosphere, leading to testable hypotheses for its origin, whether geochemical or biogenic.³³

Interstellar molecular clouds and circumstellar envelopes are space environments where solid-state chemical reactions form a variety of complex molecules. Organic compounds are ubiquitous in the Milky Way and other galaxies and include nitriles, aldehydes, alcohols, acids, ethers, ketones, amines, and amides, as well as long-chain hydrocarbons.^{34,35} The origin of organic molecules in meteorites is complex; some compounds formed as coatings on presolar dust grains in molecular clouds, and others were altered in the warmed interiors of planetesimals when ices in these bodies melted.³⁶ Their chemistries span a range of molecules including amino acids; these molecules provide a partial picture of the prebiotic components that led to life. But we lack critical information on organic components in comets and Kuiper belt objects and how compositions of organic molecules may vary among these bodies. What fraction of comet material remains pristine, maintained at low temperatures with little modification? How much mixing occurred across the solar nebula as suggested by high-temperature

PREPUBLICATION COPY—SUBJECT TO FURTHER EDITORIAL CORRECTION

silicates in Stardust samples? What kind of reactions occurred between organic compounds and silicate or oxide grains? Analysis of elemental, isotopic, organic, and mineralogical composition of organic-rich asteroid and comet surface samples (eventually, cryogenically preserved samples) using the most advanced analytical laboratory techniques holds the greatest potential for addressing these fundamental questions and tracing the origins and sources of primitive organics that led to life in the inner solar system.

Titan is the richest laboratory in the solar system for studying prebiotic chemistry with a broad range of active organic synthesis. A few percent methane in the thick cold nitrogen atmosphere moves in a global cycle, forming clouds, rain, rivers, lakes and seas that strikingly resemble Earth's hydrological cycle. Exposed to solar ultraviolet radiation and plasma particles in the upper atmosphere, methane and nitrogen are broken into radicals and ions that recombine in multiple stages to form a plethora of hydrocarbons and nitriles, ranging from simple gases to large complex molecules. As these compounds descend they condense as liquids and as a haze of organic aerosols (tholins) that rain onto the surface.

A key question posed by Cassini data is: do the organics contain amino acids and the building blocks of nucleotides?³⁷ Because the prebiotic chemical pathways of its organic evolution may hold keys for understanding the origin of life on Earth, direct examination of the organic species and active processes and the isotopic chemistry, both from the surface and in the atmosphere, has become one of the highest scientific priorities for the future.

Icy satellites display abundant evidence for organic chemistry. At Saturn, Iapetus and Phoebe are largely covered by complex dark organics. Ganymede and Callisto and all five uranian satellites exhibit numerous dark organic-rich geologic units. Cassini discovered that the plumes emanating from Enceladus's interior contain organic compounds that could be primordial, derived from accretion, or that might be generated by chemical reactions such as Fischer-Tropsch reactions (H_2 and CO) or serpentinization reactions (H_2O , CO_2 , and silicates).³⁸ As discussed below, Europa probably harbors a subsurface ocean at a shallow depth giving it high potential as a habitat for life. Satellite plumes have been observed on several geologically active bodies (Io, Enceladus, and Triton) and it would not be surprising to find them on Europa as well.³⁹ If so, characterization of Europa's organics could be done in situ as for Enceladus. High scientific goals that emerge from this key question are to identify organic molecules and characterize processes of organic synthesis in the interiors and at the surfaces of Europa and Enceladus as well as Titan.

Evidence for the possible presence of methane in Mars's atmosphere is a most remarkable recent report. If methane is confirmed it is likely being continually generated because the current abundance reported could be photochemically destroyed in only a few hundred years. All of the possible processes that have been suggested would operate in the subsurface: geological processes including metamorphic reactions of ultramafic rocks with carbonic acid (serpentinization), thermal decay of organics, or even conceivably by extant subsurface microorganisms. New questions and new goals arise. Can the detection of methane be confirmed, and how can we test hypotheses for its origin?

The ESA-NASA Mars Trace Gas Orbiter mission now under development for launch in 2016 seeks to answer these questions. It will map key isotopes and trace gases in an attempt to assess the geological or possible biological activity by which methane is evolved. Whether other complex organic compounds could have been produced in early reducing atmospheric conditions, or by mineral-catalyzed reactions, perhaps ongoing synthesis in the subsurface today, constitutes a most fundamental question in addressing whether life ever arose on Mars. The Mars Science Laboratory will begin to address these questions, making progress toward understanding carbon chemistry and early prebiotic processes. However, definitive answers to these key life-related questions will almost certainly require return of samples from Mars.

Did Mars or Venus Host Ancient Aqueous Environments Conducive to Early Life, and Is There Evidence that Life Emerged?

Today the surfaces of Mars and Venus are hostile environments for survival of any life. Venus's massive carbon dioxide atmosphere exhibits an intense greenhouse enhanced by sulfuric acid clouds resulting in a surface temperature of about 740 K. Mars's surface environment is a cold desert that is chemically oxidizing; its sparse atmosphere allows intense solar ultraviolet radiation to bathe the surface; the existence of life on Mars's surface today is likely prohibited. However, during the first half billion years or so of their early histories, the surface environments of Mars and Venus may have been wet, with temperatures and chemistries conducive for life to develop.⁴⁰ Comparative planetology seeks to understand Earth's processes and history (in this case, the early Earth) through study of its close neighbors. Beyond liquid water and clement stable environments, Earth-like life would require key organic molecules and energy sources. In exploring these ancient surface habitats and in searching for evidence that they once sustained life, all of these factors must be considered.

In the last decade our picture of ancient Mars has been dramatically advanced. The geology and mineralogy of the oldest terrains (Noachian) that extend back into the period of intense bombardment provide convincing evidence that there was ample liquid water at the surface. The geological indicators include high-density drainage networks, delta deposits, sedimentary fabrics formed in standing water, and evaporite deposits. This wet period evidently tapered off during the Hesperian and effectively ceased by 3.5 billion years ago.⁴¹

Why did this clement period not persist throughout geologic time? Mars Global Surveyor discovered a dynamo-driven magnetic field that could have held off the solar wind and protected the loss of the early thick atmosphere and its abundant water. But the dynamo was not sustainable and the field collapsed after a few hundred million years, close to the end of the late heavy bombardment, perhaps allowing much of the atmosphere to be eroded away.⁴²

We have also uncovered evidence that the chemical conditions in this postulated early warm aqueous period could have been very different than in subsequent eras. With abundant water in a mainly carbon dioxide atmosphere, widespread carbonates would be expected to have formed. Although carbonate has been found in martian meteorites, searches for its exposure at the surface were unsuccessful for decades.

Mars Exploration Rover data show at two globally separate sites that in the early Hesperian the aqueous chemistry was dominantly acidic. Mars Express and Mars Reconnaissance Orbiter identified many isolated regions containing phyllosilicates in older deposits; these would have required more neutral conditions to form. Perhaps long-lived, widespread volcanism led to a shift to sulfurous acidic conditions erasing evidence of older carbonate-bearing rocks.⁴³

Recently the Mars Reconnaissance Orbiter and the Spirit rover have found carbonate rocks in ancient strata. These Noachian carbonates must have formed under far less acidic conditions. Whether this shift occurred uniformly on a global scale or more locally, varying from region to region, or from surface to subsurface remains controversial.⁴⁴

Old carbonates have important ramifications: they suggest that this could have been the period in Mars's history that was most conducive for the emergence of life at its surface. Armed with these new perspectives, we are poised to search Mars's ancient records for both the organic building blocks and any evidence that points to the possible emergence and preservation of signs of life.

Theoretical studies suggest that prior to ~4 billion years ago the surface of Venus may have been far cooler than it is today, with liquid water, even oceans, at its surface leading to the possibility of early life.⁴⁵ This would have been a time when solar luminosity was lower and when Venus's thick, 100-bar atmosphere with its abundance of carbon dioxide and other greenhouse gases had not fully outgassed from the interior. Subsequently, as the Sun's luminosity increased, water evaporated and carbon dioxide became ever more abundant, leading to a runaway greenhouse and to the current hot, dry surface environment.

Today the atmosphere shows a much higher ratio of deuterium to hydrogen than other solar system bodies, providing evidence that ancient water was photodissociated in the upper atmosphere and lost to space, although the rate remains under debate. Venus Express measurements provide evidence that water is still being lost, as the escaping hydrogen and oxygen occur in the 2:1 ratio for water. Characterizing Venus's early environment, whether it was habitable with liquid water present is a scientific high priority; this will require measurement of the molecular and isotopic composition of the lower atmosphere and the elemental and mineralogical composition of surface.⁴⁶

Beyond Earth, Are There Modern Habitats Elsewhere in the Solar System with Necessary Conditions, Organic Matter, Water, Energy, and Nutrients to Sustain Life, and Do Organisms Live there Now?

Habitats for extant life at the surfaces of planets are rare. Venus is too hot; the rest of solar system surfaces, including that of Mars, are exposed to deadly solar ultraviolet and ionized particle radiation. If modern-day habitats for life do exist, most likely they are below the surface. Titan is the exception, the only world beyond Earth that harbors a benign surface environment, albeit extremely cold, that also is shielded from deadly radiation.

We herein make the assumption that life elsewhere in the solar system will be like terrestrial life and thereby recognizable to us. For Earth-like life forms to arise and survive in subterranean planetary habitats would require liquid water; availability of organic ingredients including carbon, nitrogen, hydrogen, oxygen, phosphorus, and sulfur; and, absent sunlight, some form of chemical energy to drive metabolism. Mars, Europa, and Enceladus hold the greatest potential as modern habitats for Earth-like life, and Titan affords the greatest potential as a prebiotic organic laboratory, conceivably harboring some very different style of life. As our cosmic perspective of the probability of life elsewhere in the universe expands, characterizing potential solar system habitats has become a priority.

Discovery of liquid water in the subsurfaces of the icy Galilean satellites and probably Enceladus has markedly advanced their priority for further exploration in the context of this question. The Galileo mission detected internal oceans in Europa, Ganymede, and Callisto from magnetic signatures induced by Jupiter's magnetic field.⁴⁷ That the oceans are electrically conductive suggests they are salty and, in fact, signatures of salts have been found in surface spectra. Although the depths and compositions are still poorly constrained, models suggest the overlying ice crusts might only be 4-30 kilometers thick in Europa's case but far thicker for Ganymede and Callisto.

Our understanding is that the interiors of Ganymede and Callisto are warmed mostly by weak radiogenic heat sources but that Europa undergoes more energetic tidal heating that should result in a much thinner ice cover capping its ocean. These factors combine to make Europa's ocean the highest priority in the outer solar system to explore as a potential habitat for life. Characterization of its internal ocean and ice shell, searching for plumes and evidence of organics are key goals for this decade.

Discovery of plumes jetting from fractures in the polar plains of tiny Enceladus is a stunning discovery. Salt-rich grains in the plumes evidence subsurface liquid water.^{48,49} Cassini also revealed that the plumes exhaust organic molecules, including methane—proffered explanations include thermal decay of primordial organics, Fischer-Tropsch, and rock-water reactions, or conceivably biological processes. Biotic and abiotic organics can be distinguished, for example from their chirality. Detailed characterization of the molecular and isotopic chemistry of the organics and volatiles in Enceladus's plumes emerges as an important scientific priority.

Today the subsurface of Mars is likely more hospitable for life than is its ultraviolet-irradiated surface.⁵⁰ With an average equatorial surface temperature of ~215 K, icy conditions extend globally to depths of kilometers over most of the planet. Still, liquid water might exist near the surface in some special places, particularly as brine solutions. Geologically young lava plains suggest relatively high heat flow and melting of near surface ice. Although as yet undetected, hydrothermal activity likely also persists and could maintain aqueous habitats at shallow depth.

PREPUBLICATION COPY—SUBJECT TO FURTHER EDITORIAL CORRECTION

We lack critical geophysical data about Mars’s interior structure; ultimately seismic measurements will be our best means to reveal volcanic and hydrothermal regimes in the crust. In any case biological habitats could exist in groundwater systems in permeable layers only a few kilometers down. Driven by large excursions in Mars’s axial tilt, recent climate changes may have increased atmospheric water content and caused substantial surface ice to be transported from the poles to lower latitudes.

In addition to liquid water, subsurface martian life would require organics and energy to drive metabolism. The putative discovery of atmospheric methane has tremendous implications for subsurface habitats and extant life.⁵¹ Some active subsurface processes—volcanism, aqueous reactions with rocks, decay of organics, or conceivably microorganisms—would be necessary to maintain it. Results of the ESA-NASA Trace Gas Orbiter are key to this question. However, answering the question of the existence modern martian habitats and life forms with confidence will demand sophisticated laboratory analyses of samples collected from sites with the highest potential as subsurface habitats.

Titan offers the only plausible modern surface habitat beyond Earth that is shielded from radiation. It also provides the richest and most accessible laboratory to explore active organic synthesis on a planetary scale. Methane and nitrogen are energetically decomposed high in the atmosphere, initiating a series of reactions producing a wide variety hydrocarbons and nitriles, conceivably including amino acids and nucleotides. The existence of methanogenic organisms has even been speculated in the organic-rich deposits that mantle its surface or in its polar lakes and seas.

What energy might drive the metabolic processes? First sunlight, absent sterilizing ultraviolet and particle radiation, reaches the surface. Unsaturated organics such as acetylene and ethane, products of atmospheric reactions, could react with hydrogen releasing energy at rates comparable to those used by microorganisms on Earth.⁵² Measurements of the concentration of hydrogen and reactive organics in the surface environment could test such hypotheses. Detailed examination of the nature and interaction of the rich array of solid and liquid organic compounds in Titan’s surface environment is a high priority that would reveal new insights into organic chemical evolution on a global scale and, conceivably, detect ongoing biological processes.

WORKINGS OF SOLAR SYSTEMS: REVEALING PLANETARY PROCESSES THROUGH TIME

How do the Giant Planets Serve as Laboratories to Understand Earth, the Solar System, and Extrasolar Planetary Systems?

Among the mind-stretching advances in space science of the last ten years is the recognition of the immense diversity of planets orbiting other stars; those confirmed number nearly 500 as of the writing of this report.⁵³ These worlds exhibit an incredible array of planetary characteristics, orbits, and stellar environments. Moreover, some of these planetary systems are found to contain multiple planets. Some exoplanets orbit close to their stellar companions; some have orbits that are highly eccentric or even retrograde. In size and composition known exoplanets range from massive super-Jupiters, mostly hydrogen and helium, to Uranus- and Neptune-sized ice giants, dubbed water worlds, down to super-Earths seeming to have ice-rock compositions.⁵⁴ Discovery and characterization of watery Earth-sized planets are likely within the decadal horizon. New areas of research seek to extrapolate the understanding of the solar system to exoplanets—therefore more complete knowledge of the origin, evolution, and operative processes in our solar system, in particular of the giant planets, becomes ever more urgent.⁵⁵

Exoplanets exist in broad range of stellar conditions and illustrate extremes in planetary properties. Many exoplanets “inflated” by close proximity to their star have radii much larger than can be explained by our best thermal history models. Hot Jupiters orbit close in where the internal heat flow is dwarfed by enormous stellar fluxes; others exhibit the reverse, orbiting far from their central stars.⁵⁶ Analogously, Uranus’s heat flow is a small fraction of the solar flux but at Jupiter the two are similar.

PREPUBLICATION COPY—SUBJECT TO FURTHER EDITORIAL CORRECTION

Exoplanet internal magnetic field strengths are unknown. Exoplanets in tight orbits could experience intense magnetospheric interactions with strong stellar winds. In extreme cases a planetary atmosphere could extend beyond the magnetosphere and be rapidly scavenged by stellar winds. Star-planet interactions could take many forms: Venus-like if the internal magnetic field is weak, Earth-like with aurora if the field is strong, or Jupiter-like if the planet is rapidly rotating and the magnetosphere contains plasma. Uranus and Neptune have tilted magnetospheres offset from their centers, configurations that could provide new insights into ice-giant exoplanets.⁵⁷ Just as giant planets and exoplanets are closely linked, giant planet ring systems serve as important analogs to help understand exoplanet nurseries in circumstellar disks.^{58,59,60}

The population of ice-giant exoplanets is growing rapidly. Three were detected by transit across their central stars; many more are evident in the early data from the Kepler mission and await confirmation.⁶¹ Evidently abundant, these objects are similar in size and composition to Neptune and Uranus—the giant planets about which we know the least. For Jupiter, the Galileo probe provided critical data on isotopes, noble gases, deep winds, and thermal profiles—data that we lack now for Saturn, Uranus, and Neptune.

Jupiter fits reasonably well our basic model of giant planet evolution. Saturn, however, is much warmer than the simple models predict; in fact, Saturn's ratio of internal heat to absorbed solar heat is greater than Jupiter's. One long-held theory is that helium rain falls to the deep interior, converting potential energy into kinetic energy and thereby heating the interior and prolonging its warm state. Direct measurement of the helium abundance would test this hypothesis. In conjunction with the Cassini mission, acquiring data on the isotopic composition of noble gases and other key elemental and molecular species would fill enormous gaps in our understanding of Saturn's formation and evolution.

Our knowledge of the interior states, chemistry, and evolution of Uranus and Neptune is even more primitive than for Saturn. More than two decades ago Voyager showed Neptune's heat flow to be about 10 times and Uranus's to be about three times larger than expected from radioactive heat production—the causes are still unknown. Measuring key elemental and isotopic abundances and thermal profiles in the atmospheres of Saturn, Uranus, and Neptune is essential if we are to advance our understanding of the properties and evolution of gas giants, both in our own solar system and in extrasolar planetary systems.

Cassini is revealing a wealth of dynamical structures in Saturn's rings. Accretion appears ongoing in Saturn's F ring, gravitationally triggered by close satellite passages.^{62,63} Non-gravitational forces like electromagnetism drive dusty rings like Saturn's E ring, Jupiter's gossamer rings, and Uranus's "zeta" ring. The physical processes that confine Uranus's narrow, string-like rings are a mystery—when solved this could open a new chapter in understanding ring and circumstellar disk processes.^{64,65} Exploring the rings of Saturn, Uranus, and Neptune is of high scientific priority, deepening not only understanding of these giant planet systems but also providing new insights into exoplanet processes and their formation in circumstellar disks albeit of enormously different scale.

What Solar System Bodies Endanger and What Mechanisms Shield Earth's Biosphere?

As the geological record demonstrates, comets and asteroids have struck Earth throughout its history, sometimes with catastrophic results. Most believe that a roughly 10-km impactor triggered the global-scale extinction at the Cretaceous-Paleogene boundary 65 million years ago (historically referred to as the K-T boundary). Objects smaller than approximately 30 meters in diameter almost completely burn up in Earth's atmosphere. But larger objects explode in the lower atmosphere or impact the surface and can pose a threat to human life.

The 2010 NRC report *Defending Planet Earth: Near-Earth-Object Surveys and Hazard Mitigation Strategies* addressed the dangers posed to Earth by asteroids (particularly near-Earth objects, or NEOs) and comets.⁶⁶ The report stated that the risk is small, but that unlike other catastrophic events, such as earthquakes, it can not only be mitigated but also potentially eliminated if hazardous objects are

PREPUBLICATION COPY—SUBJECT TO FURTHER EDITORIAL CORRECTION

detected in time. The report concluded that there were two approaches to completing a congressionally mandated survey of hazardous objects. The more expensive but more expedient method requires both a space-based survey telescope and a suitable ground-based telescope (i.e. a telescope capable of both detecting relatively dim objects and also possessing a wide field of view enabling it to survey large portions of the night sky). The more cost-effective method could be accomplished with a suitable ground-based telescope over a longer period of time, provided that non-NEO programs primarily paid for the telescope.

The 2010 astronomy and astrophysics decadal survey report *New Worlds, New Horizons in Astronomy and Astrophysics* ranked the Large Synoptic Survey Telescope (LSST) as its top-priority ground-based telescope, stating that it “would employ the most ambitious optical sky survey approach yet and would revolutionize investigations of transient phenomena.”⁶⁷ The LSST was given first priority as “a result of its capacity to address so many of the identified science goals and its advanced state of technical readiness.” From the perspective of planetary science, the LSST will yield a rich new data base that can not only be mined to search for hazardous near-Earth objects but would also be of major scientific value in advancing primitive body exploration extending out into the Kuiper belt.

Although impact hazards to Earth are real, they are probably actually reduced by the gravitational influence of the giant planets, especially Jupiter. Astronomical surveys tally the number of asteroids larger than a kilometer at about a million. But, comet nuclei this size and larger are probably far more numerous. When these objects are deflected into elliptical orbits that would bring them close to Earth they often also cross Jupiter’s orbit. Simulations with large samples of orbital encounters show that Jupiter deflects some on harmless trajectories that cross into the inner solar system, and that most are ejected out of the solar system. In aggregate, then, Jupiter protects Earth.⁶⁸

Since the remarkable prediction of the impact of Shoemaker-Levy 9 with Jupiter in 1994 we have witnessed three new jovian impacts as of this writing, one in 2009 and two in 2010.⁶⁹ The orbits and impact rates of Jupiter impactors provides new information to understand how Jupiter deflects hazards toward or away from Earth. Therefore continuous monitoring of Jupiter to capture these events would be invaluable. Today, such work relies on a small number of highly motivated amateur observers; these unfunded volunteers, however, cannot cover Jupiter at all times. Small, dedicated automated planetary monitoring telescopes would be of great value in providing comprehensive surveys to capture future impacts into Jupiter.

Can Understanding the Roles of Physics, Chemistry, Geology, and Dynamics in Driving Planetary Atmospheres and Climate Lead to a Better Understanding of Climate Change on Earth?

Venus, Mars, Titan, Jupiter, Saturn, Uranus, Io, Pluto, Neptune, and Triton display an enormous range of active atmospheres that in many respects are far simpler than that of Earth—an arguably more difficult atmosphere to model and to understand. The interactions of Earth’s atmosphere, biosphere, lithosphere, and hydrosphere present extremely complex, even chaotic, problems that defy our ability to reliably predict their future or derive their past, either on short or long timescales. Venus, Mars, and Titan provide atmospheric laboratories that exhibit many Earth-like characteristics but operate across the spectrum of temperature, pressure, and chemistry. Likewise, giant planet atmospheres are also in many respects much simpler to understand than is Earth’s. The processes that drive thick atmospheres can be modeled without the complication of a liquid or solid surface.

Consideration of the full suite of planetary atmospheres immensely broadens the scope of atmospheric science. The goal to understand the full spectrum of planetary atmospheres—the physics, chemistry, dynamics, meteorology, photochemistry, solar wind and magnetospheric interactions, response to solar cycles, and particularly greenhouse processes—drives a richer and more comprehensive perspective in which Earth becomes one example.

Venus and Earth are nearly identical in size and bulk density, but Venus’s massive atmosphere presents an extremely different system when compared with Earth’s. The upper reaches of its hot, dense

carbon dioxide atmosphere, laden with sulfuric acid clouds, circle the planet every 4 days. Venus Express discovered that lightning, aurora, and nightglows light up the planet's sky.⁷⁰ Evidence of active volcanism is also suggested, supporting the idea that ongoing volcanic emission of sulfur dioxide feeds the thick sulfuric acid clouds. What mechanisms triggered Venus's runaway greenhouse and on what timescale remain open questions.⁷¹ Addressing them can help us better understand the principles of greenhouse atmospheres in general, placing Earth's in a broader context. For Venus, addressing these questions requires measurements of atmospheric chemistry, notably of the isotopic and noble gas chemistry of the lower atmosphere. Establishing the initial climate conditions and modern states of Venus and Mars can help us to understand how their environments diverged so dramatically from Earth's.

Mars has perhaps the most Earth-like modern planetary atmosphere, and its earliest climate may have been very Earth-like. Studying it therefore provides opportunities to validate terrestrial climate and global circulation models under very different atmospheric conditions. Mars's polar layered deposits suggest climate change in the last 10 million years, and dynamical models predict large recent excursions in axial tilt and orbital eccentricity.⁷² These considerations point to recent climatic change, analogous to ice ages on Earth, detailed records of which are likely preserved in the polar layered deposits. During Mars's postulated early warm wet climate solar luminosity is thought to have been ~25 percent lower than today. This fact has made it difficult for atmosphere modelers to understanding how Mars's greenhouse could have sustained such warm conditions, but the geologic evidence for Noachian rivers and lakes is compelling. The continued investigation of Mars's climate through time and the study of its modern atmospheric processes from orbit, from the surface, and ultimately from analysis of returned samples conditions remain high priority scientific objectives.

Flow within giant planet atmospheres is largely organized in east-west jet streams. Whereas Jupiter and Saturn exhibit alternating east-west jets, Uranus and Neptune show broad belts of retrograde winds at the equator shifting to prograde with increasing latitude. Vortices, cyclonic and anticyclonic, at many scales spin between the jets and resemble weather features seen on Earth ranging from tornados to hurricanes. North-south circulation continually overturns belt-zone system in Hadley-like convection cells and by wave forcing.^{73,74} Major questions remain as to how these motions, visible in the layered cloud decks, couple to the interior structure and deep circulation. The Juno and Cassini Solstice missions may detect gravitational signatures of deep internal flow in Jupiter and Saturn. The most serious gap in our understanding of planetary atmospheres remains for the ice giants, Neptune and Uranus.

The giant planets also provide the only examples of processes common to Earth in which strong internal magnetic fields interact with the solar wind. This includes the fluorescing spectacle of Earth's northern lights and similar auroral displays seen near the magnetic poles of Jupiter and Saturn. At Jupiter and Saturn the main sources feeding the magnetospheric plasma appear to be Io, Enceladus, and Saturn's rings, while most of the magnetospheric plasma at Earth is trapped solar wind. These interactions pose major consequences for humans; understanding and predicting them is important. The solar wind induces magnetospheric storms that disrupt power and communication systems worldwide. The giant planets provide a wide spectrum of observable magnetospheric processes that can contribute directly to an understanding of the physics at work in Earth's space environment.

One of the most startling revelations of the last decade is how much the processes ongoing in Titan's thick global atmosphere and on its surface resemble those of Earth. Both worlds have nitrogen-dominated atmospheres with about the same surface pressure.⁷⁵ However in Titan's ultra cold meteorology, methane migrates through a global system of clouds, rain, rivers, lakes, seas, and aquifers: the analogy to Earth's hydrological cycle is obvious. The mechanics and chemistry of this atmosphere are complex but pale in comparison to the complexity of Earth's. In our quest to understand greenhouse mechanisms, Titan's atmosphere manifests both greenhouse warming and anti-greenhouse cooling, puzzling diametric cases in which thermal radiation is sometimes trapped and sometimes radiated to space. The Cassini-Huygens spacecraft arrived at Saturn near northern winter/summer solstice and the mission will be extended through northern summer solstice, allowing unprecedented view of Titan's seasonal behavior. Continued exploration of this fascinating Earth-like atmosphere, both from orbit and in situ, remains one of the most important objectives for planetary science.

PREPUBLICATION COPY—SUBJECT TO FURTHER EDITORIAL CORRECTION

How Have the Myriad of Chemical and Physical Processes that Shaped the Solar System Operated, Interacted, and Evolved Over Time?

In searching for answers to the overarching questions, we first seek a deep understanding of the chemical and physical processes that have shaped planetary interiors, surfaces, atmospheres, rings, and magnetospheres through time. Since 1977 when the Voyager spacecraft left Earth, our perspectives regarding the complexity and diversity of the solar system have undergone immense revision and expansion. Ranger, Surveyor, and Apollo data showed that the Moon's geologic evolution ended long ago. Mariner 10's visit to Mercury showed a similar picture—an ancient, impact-riddled, and geologically dead world. Mariners 4, 6, 7, and 9 flew by and orbited Mars, and again revealed a mostly cratered volcanic world, but one also with jumbled chaotic terrains, gargantuan canyons, exotic polar deposits, and outflow channels and drainage networks of a watery but ancient origin. Even with Mars's profusion of geologic processes, it too appeared to be inactive, a frigid desert world.

As had been predicted, Voyager found that Jupiter's moon Io is the most intensely volcanic object in the solar system; volcanic plumes fountain up to 300 kilometers and not a single impact crater has been found anywhere on its young volcanic plains. Galileo confirmed that the surface of Io continues to evolve rapidly, discovering molten lakes of silicates and sulfur-rich lavas and active fire fountains. New Horizons provided elegant movies of an eruption in progress. Caught in a celestial dance that also involves Jupiter, Europa, and Ganymede, Io is intensely heated by tides and remains one of the best places in the solar system to study active volcanism and tidal heating.

Turning to the other Galilean satellites, the Galileo mission found all three to have internal oceans.⁷⁶ Of the three, the ceiling of Europa's ocean chamber is thought to be at the shallowest depth because, although less so than Io, it is also tidally heated. In addition because its large rocky interior, upon which the ocean rests, is subjected to both tidal and radiogenic heating, it is reasonable to expect seafloor volcanism and hydrothermal activity that could provide nutrients and energy to support metabolism.⁷⁷ These factors combine to make Europa, along with Mars, the highest priority destinations in the solar system as potential planetary habitats.

For the jovian system we have learned to expect the unexpected. Galileo showed Ganymede, the only satellite in the outer solar system known to have an internal magnetic field and a magnetosphere. Galileo's probe into the jovian atmosphere revealed the noble gas abundances were very unlike the Sun's—processes like helium rain falling into Jupiter's core have been invoked as possible explanations, and more recent observations have shown a dynamic, ever-changing atmosphere, riddled by impacts.⁷⁸

Saturn's excessive thermal energy might also signal helium rain; direct measurement of its noble gas abundance and isotopic chemistry is required to get an answer. Cassini confirmed exquisite features in Saturn's atmosphere: the Voyager-detected hexagonal circumpolar jet rotating around Saturn's north pole and a hot, hurricane-like, vortex with newly discovered well-defined eye wall circles in the south. That a tiny icy moon could be warm enough to maintain liquid water in its interior driving jets out if its broken crust, make Enceladus a key destination.^{79,80} Mimicking Earth, Titan has seas of organic sand dunes, hydrocarbon lakes, dendritic river systems, putative icy volcanism, mountain chains, and global fault systems—Titan ranks near the top as a target of future exploration.⁸¹

At Neptune Voyager found nitrogen geysers fountaining up into the stratosphere from Triton's ultra-cold, 37 K surface—perhaps driven by a greenhouse effect as subliming gas rushes to vents under clear nitrogen ice. Originally we thought only Saturn among the giant planets possesses a ring system. As it turns out so do Jupiter, Uranus, and Neptune, and these systems all differ dramatically. Neptune possesses orbiting arcs forming partial rings; dense dark rings interspersed with broad sheets of nearly invisible dust encircle Uranus; Jupiter's gossamer ring orbits as a dusty wreath.^{82,83} We are only beginning to uncover the nature and ages of the ring materials.

We have had tantalizing glimpse of conditions and configurations in the ice giants themselves: oddly tilted and offset magnetic fields, unexplained sources of heat, supersonic atmospheric motions. Of the major objects of the solar system, we understand these ice-giant worlds least. Because recent

discoveries suggest such bodies may dominate the population of exoplanets, filling this gap in our knowledge rates as a high priority.

New lessons from the inner solar system over the last few decades show it, too, is far more complex and active than previously known—discoveries here are equally exciting. Venus may harbor active volcanic eruptions issuing sulfurous compounds and water vapor to feed the sulfuric acid clouds.⁸⁴ Mars is also far more active than we earlier thought, with changes on the timescale of only a few years: new impact scars, new landslides, and active processes occurring in gullies.⁸⁵ Time-lapse movies from the Mars rovers show dust devils racing across surface. We have new evidence for glaciers on Mars, extending even to the equator in places and active or recent subsurface processes, of hidden origin, generating methane. Mars's hydrothermal and volcanic activity likely extends through today but confirmation will require seismic data, a critical area for future investigation. We have found strange “active” asteroids in the main belt jetting dust and gas, behaving like comets. Once the Moon had global oceans of molten lava, today its seismic tremors can elucidate its internal structure and yield secrets of its early origin and evolution.

In summary, we have come full circle in our view of how complex, diverse, and often active the processes that drive the solar system are. In the end, we have come to realize that as we explore, our expectations commonly fall short of what nature has in store for us in the unknown reaches of the solar system and the universe.

REFERENCES

1. National Research Council, *An Integrated Strategy for the Planetary Sciences: 1995-2010*, National Academy Press, Washington, D.C., 1994, pp. 33-34.
2. National Research Council, *New Frontiers in the Solar System: An Integrated Exploration Strategy*, The National Academies Press, Washington, D.C., 2003, pp. 156-158.
3. J. Williams. The astrophysical environment of the solar birthplace. *Contemporary Physics* 51:381-396.
4. M. Bizzarro, D. Ulfbeck, A. Trinquier, K. Thrane, J.N. Connelly, and B.S. Meyer. Evidence for a late supernova injection of ⁶⁰Fe into the protoplanetary disk. *Science* 316(5828):1178-1181.
5. E. Zinner. Presolar grains. Pp. 17-39 in *Treatise on Geochemistry, Volume 1: Meteorites, Comets, and Planets* (A.M. Davis, ed.). Elsevier, Oxford.
6. T.J. Bernatowicz, T.K. Croat, and T.L. Daulton. 2006. Origin and evolution of carbonaceous presolar grains in stellar environments. Pp. 109-126 in *Meteorites and the Early Solar System II* (D.S. Lauretta and H.Y. McSween, eds.). University of Arizona Press, Tucson, Ariz.
7. H.A. Ishii, J.P. Bradley, Z.R. Dai, M. Chi, A.T. Kearsley, M.J. Burchell, N.D. Browning, and F.J. Molster. 2008. Comparison of comet 81P/Wild2 dust with interplanetary dust from comets. *Science* 319:447-450.
8. H.Y. McSween and G.R. Huss. 2010. *Cosmochemistry*. Cambridge University Press.
9. K. Tsiganis, R. Gomes, A. Morbidelli, and H.F. Levison. 2005. Origin of the orbital architecture of the giant planets of the solar system. *Nature* 435:459-461;
10. A. Morbidelli, H.F. Levison, K. Tsiganis, and R. Gomes. 2005. Chaotic capture of Jupiter's Trojan asteroids in the early solar system. *Nature* 435:462-465.
11. D. Brownlee and 181 coauthors. 2006. Comet 81P/Wild2 under a microscope. *Science* 314:1711-1716.
12. T. Kleine, M. Touboul, B. Bourdon, F. Nimmo, K. Mezger, H. Palme, S.B. Jacobsen, Q.-Z. Yin, and A.N. Halliday. 2009. Hf-W chronology of the accretion and early evolution of asteroids and terrestrial planets. *Geochimica et Cosmochimica Acta* 73:5150-5188.

PREPUBLICATION COPY—SUBJECT TO FURTHER EDITORIAL CORRECTION

13. P.R. Estrada, I. Mosqueira, J.J. Lissauer, G. D'Angelo, and D.P. Cruikshank. 2009. Formation of Jupiter and conditions for accretion of the Galilean satellites. Pp. 27-58 in *Europa* (R. Pappalardo, W. McKinnon, and K. Khurana, eds.). University of Arizona Press, Tucson, Ariz.
14. J. Lunine, M. Choukroun, D. Stevenson, and G. Tobie. 2009. The origin and evolution of Titan. pp. 75-140 in *Titan from Cassini-Huygens* (R. Brown, J-P. LeBreton, and J.H. Waite, eds.). Springer, Heidelberg;
15. S. Atreya, R. Lorenz, and J.H. Waite. 2009. Volatile origin and cycles: Nitrogen and methane. Pp. 177-199 in *Titan from Cassini-Huygens* (R. Brown, J-P. LeBreton, and J.H. Waite, eds.). Springer, Heidelberg.
16. F. Hersant, D. Gautier, G. Tobie, and J.I. Lunine. 2008. Interpretation of the carbon abundance in Saturn measured by Cassini. *Planetary and Space Science* 56:1103-1111.
17. K. Tsiganis, R. Gomes, A. Morbidelli, and H.F. Levison. 2005. Origin of the orbital architecture of the giant planets of the solar system. *Nature* 435:459-461;
18. A. Morbidelli, H.F. Levison, K. Tsiganis, and R. Gomes. 2005. Chaotic capture of Jupiter's Trojan asteroids in the early solar system. *Nature* 435:462-465.
19. J.-M. Petit and A. Morbidelli. 2001. The primordial excitation and clearing of the asteroid belt. *Icarus* 153:338-347.
20. D.P. O'Brien, A. Morbidelli, and H.F. Levison. 2006. Terrestrial planet formation with strong dynamical friction. *Icarus* 184:39-58.
21. K. Tsiganis, R. Gomes, A. Morbidelli, and H.F. Levison. 2005. Origin of the orbital architecture of the giant planets of the solar system. *Nature* 435:459-461.
22. N.H. de Leeuw, C.R.A. Catlow, H.E. King, A. Putnis, K. Muralidharan, P. Deymier, M. Stimpfl, and M.J. Drake. 2010. Where on Earth has our water come from? *Chemical Communications* 46(47):8923. doi: 10.1039/c0cc02312d.
23. R. Gomes, H.F. Levison, K. Tsiganis, and A. Morbidelli. 2005. Origin of the cataclysmic late heavy bombardment period of the terrestrial planets. *Nature* 435:466-469.
24. R.G. Strom, R. Malhotra, T. Ito, F. Yoshida, and D.A. Kring. 2005. The origin of planetary impactors in the inner solar system. *Science* 309:1847-1850.
25. K. Tsiganis, R. Gomes, A. Morbidelli, and H.F. Levison. 2005. Origin of the orbital architecture of the giant planets of the solar system. *Nature* 435:459-461.
26. D. Brownlee and 181 coauthors. 2006. Comet 81P/Wild2 under a microscope. *Science* 314:1711-1716.
27. A.N. Halliday. 2004. The origin and earliest history of the Earth. Pp. 509-557 in *Treatise on Geochemistry, Vol. 1. Meteorites, Comets, and Planets* (A.M. Davis, ed.). Elsevier, Oxford.
28. N. Mueller, J. Helbert, G.L. Hashimoto, C.C.C. Tsang, S. Erard, G. Piccioni, and P. Drossart. 2008. Venus surface thermal emission at 1 μm in VIRTIS imaging observations: Evidence for variation of crust and mantle differentiation conditions. *Journal of Geophysical Research* 113(E9):E00B17, doi:10.1029/2008JE003225.
29. G.L. Hashimoto, M. Roos-Serote, S. Sugita, M.S. Gilmore, L.W. Kamp, R.W. Carlson, and K.H. Baines. 2008. Felsic highland crust on Venus suggested by Galileo Near-Infrared Mapping Spectrometer data. *Journal of Geophysical Research* 113:E00B24, doi:10.1029/2008JE003134.
30. H.Y. McSween. 2008. Martian meteorites as crustal samples. Pp. 383-395 in *The Martian Surface: Composition, Mineralogy, and Physical Properties* (J.F. Bell, ed.). Cambridge University Press, Cambridge, U.K.
31. F. Raulin, C. McKay, J. Lunine, and T. Owen. 2009. Titan's astrobiology. Pp. 215-233 in *Titan from Cassini-Huygens* (R. Brown, J-P. LeBreton, and J.H. Waite, eds.). Springer, Heidelberg.
32. J.H. Waite, Jr., W.S. Lewis, B.A. Magee, J.I. Lunine, W.B. McKinnon, C.R. Glein, O. Mousis, D.T. Young, T. Brockwell, J. Westlake, M.-J. Nguyen et al. 2009. Liquid water on Enceladus from observations of ammonia and 40Ar in the plume. *Nature* 460:487-490.

33. M.J. Mumma, G.L. Villanueva, R.E. Novak, T. Hewagama, B.P. Bonev, M.A. DiSanti, A.M. Mandell, and M.D. Smith. 2009. Strong release of methane on Mars in Northern Summer 2003. *Science* 323:1041-1045, doi:10.1126/science.1165243.
34. S. Kwok. 2009. Delivery of complex organic compounds from planetary nebulae to the solar system. *International Journal of Astrobiology* 8/3:161-167.
35. E. Herbst and E.F. van Dishoeck. 2009. Complex organic interstellar molecules. *Annual Review of Astronomy and Astrophysics* 47:427-480.
36. S. Piazzarello, G.W. Cooper, and G.J. Flynn. 2006. The nature and distribution of the organic material in carbonaceous chondrites and interplanetary dust particles. Pp. 625-651 in *Meteorites and the Early Solar System II* (D.S. Lauretta and H.Y. McSween, eds.). University of Arizona Press, Tucson, Ariz.
37. F. Raulin, C. McKay, J. Lunine, and T. Owen. 2009. Titan's astrobiology. Pp. 215-233 in *Titan from Cassini-Huygens* (R. Brown, J-P. LeBreton, and J.H. Waite, eds.). Springer, Heidelberg.
38. D.L. Matson, J.C. Castillo-Rogez, G. Schubert, C. Sotin, and W.B. McKinnon. 2009. The thermal evolution and internal structure of Saturn's mid-sized icy satellites. Pp.577-612 in *Saturn from Cassini-Huygens* (M.K. Dougherty, L.W. Esposito, and S.M. Krimigis, eds.). Springer, Berlin.
39. K.K. Khurana, M.G. Kivelson, K.P. Hand, and C.T. Russell. 2009. Electromagnetic induction from Europa's ocean and the deep interior. Pp. 571-586 in *Europa* (R. Pappalardo, W. McKinnon, and K. Khurana, eds.). University of Arizona Press, Tucson, Ariz.
40. M.H. Carr. 2006. *The Surface of Mars*. Cambridge University Press.
41. J.C. Andrews-Hanna, M.T. Zuber, R.E. Arvidson, and S.J. Wiseman. 2010. Mars hydrology: Meridiani playa deposits and the sedimentary record of Arabia Terra. *Journal of Geophysical Research* 115:E06002, doi: 10.1029/2009JE003485.
42. S.C. Solomon, O. Aharonson, J.M. Aurnou, W.B. Banerdt, M.H. Carr, A.J. Dombard, H.V. Frey, M.P. Golombek, S.A. Hauck II, J.W. Head III, B.M. Jakosky, C.L. Johnson, P.J. McGovern, G.A. Neumann, R.J. Phillips, D.E. Smith, and M.T. Zuber. 2005. New perspectives on ancient Mars. *Science* 307:1214-1220.
43. S.L. Murchie, J.F. Mustard, B.L. Ehlmann, R.E. Milliken, J.L. Bishop, N.K. McKeown, E.Z.N. Dobreá, F.P. Seelos, D.L. Buczkowski, and S.M. Wiseman. 2009. A synthesis of martian aqueous mineralogy after 1 Mars year of observations from the Mars Reconnaissance Orbiter. *Journal of Geophysical Research* 114:E00D06, doi:10.1029/2009JE003342.
44. R.V. Morris, S.W. Ruff, R. Gellert, D.W. Ming, R.E. Arvidson, B.C. Clark, D.C. Golden, K. Siebach, G. Klingelhofer, and C. Schroder. 2010. Identification of carbonate-rich outcrops on Mars by the Spirit Rover. *Science* 329(5990):421-424.
45. F. Taylor and D. Grinspoon. 2009. Climate evolution of Venus. *Journal of Geophysical Research* 114:E00B40.
46. M.C. Liang and Y.L. Yung. 2009. Modeling the distribution of H₂O and HDO in the upper atmosphere of Venus. *Journal of Geophysical Research* 114:E00B28.
47. K.K. Khurana, M.G. Kivelson, K.P. Hand, and C.T. Russell. 2009. Electromagnetic induction from Europa's ocean and the deep interior. Pp. 571-586 in *Europa* (R. Pappalardo, W. McKinnon, and K. Khurana, eds.). University of Arizona Press, Tucson, Ariz.
48. F. Postberg, S. Kempf, J. Schmidt, N. Brilliantov, A. Beinsen, B. Abel, U. Buck, and R. Srama. 2009. Sodium salts in E-ring ice grains from an ocean below the surface of Enceladus. *Nature* 459:1098-1101.
49. J.H. Waite, Jr., W.S. Lewis, B.A. Magee, J.I. Lunine, W.B. McKinnon, C.R. Glein, O. Mousis, D.T. Young, T. Brockwell, J. Westlake, M.-J. Nguyen et al. 2009. Liquid water on Enceladus from observations of ammonia and 40Ar in the plume. *Nature* 460:487-490.
50. National Research Council. 2007. *An Astrobiology Strategy for the Exploration of Mars*. The National Academies Press, Washington, D.C.

51. M.J. Mumma, G.L. Villanueva, R.E. Novak, T. Hewagama, B.P. Bonev, M.A. DiSanti, A.M. Mandell, and M.D. Smith. 2009. Strong release of methane on Mars in Northern Summer 2003. *Science* 323:1041-1045, doi:10.1126/science.1165243.
52. C.P. McKay and H.D. Smith. 2005. Possibilities for methanogenic life in liquid methane on the surface of Titan. *Icarus* 178:274-276.
53. W. Borucki for the Kepler Team. 2010. Characteristics of Kepler Planetary Candidates Based on the First Data Set: The Majority are Found to be Neptune-Size and Smaller. arXiv:1006.2799v1 [astro-ph.EP].
54. C. Lovos, D. Ségransan, M. Mayor, S. Udry, F. Pepe, D. Queloz, W. Benz, F. Bouchy, C. Mordasini, N.C. Santos, J. Laskar et al. 2010. The HARPS search for southern extra-solar planets. XXVII. Up to seven planets orbiting HD 10180: probing the architecture of low-mass planetary systems. *Astronomy and Astrophysics*, submitted.
55. J.I. Lunine, D. Fischer, H.B. Hammel, T. Henning, L. Hillenbrand, J. Kasting, G. Laughlin, B. Macintosh, M. Marley, G. Melnick, D. Monet, C. Noecker, S. Peale, A. Quirrenbach, S. Seager, and J.N. Winn. 2008. Worlds beyond: A strategy for the detection and characterization of exoplanets executive summary of a report of the ExoPlanet Task Force Astronomy and Astrophysics Advisory Committee Washington, D.C., June 23, 2008. *Astrobiology* 8:875-881.
56. C. Marois, B. Macintosh, T. Barman, B. Zuckerman, I. Song, J. Patience, D. Lafrenière, and R. Doyon. 2008. Direct imaging of multiple planets orbiting the star HR 8799. *Science* 322:1348.
57. S. Stanley and J. Bloxham. 2004. Convective-region geometry as the cause of Uranus' and Neptune's unusual magnetic fields. *Nature* 428(6979):151-153.
58. J.N. Cuzzi, J.A. Burns, S. Charnoz, R.N. Clark, J.E. Colwell, L. Dones, L.W. Esposito, G. Filacchione, R.G. French, M.M. Hedman, S. Kempf, et al. 2010. An evolving view of Saturn's dynamic rings. *Science* 327:1470-1475.
59. K. Beurle, C.D. Murray, G.A. Williams, M.W. Evans, N.J. Cooper, and C.B. Agnor. 2010. Direct evidence for gravitational instability and moonlet formation in Saturn's rings. *The Astrophysical Journal* 718:L176-L180;
60. S. Charnoz, J. Salmon, and A. Crida. 2010. The recent formation of Saturn's moonlets from viscous spreading of the main rings. *Nature* 465:752-754.
61. W. Borucki for the Kepler Team. 2010. Characteristics of Kepler Planetary Candidates Based on the First Data Set: The Majority are Found to be Neptune-Size and Smaller. arXiv:1006.2799v1 [astro-ph.EP].
62. K. Beurle, C.D. Murray, G.A. Williams, M.W. Evans, N.J. Cooper, and C.B. Agnor. 2010. Direct evidence for gravitational instability and moonlet formation in Saturn's rings. *The Astrophysical Journal* 718:L176-L180.
63. S. Charnoz, J. Salmon, and A. Crida. 2010. The recent formation of Saturn's moonlets from viscous spreading of the main rings. *Nature* 465:752-754.
64. M.R. Showalter and J.J. Lissauer. 2006. The second ring-moon system of Uranus: Discovery and dynamics. *Science* 311:973-977.
65. I. de Pater, H.B. Hammel, S.G. Gibbard, and M.R. Showalter. 2006. New dust belts of Uranus: One ring, two ring, red ring, blue ring. *Science* 312:92-94.
66. National Research Council, *Defending Planet Earth: Near-Earth-Object Surveys and Hazard Mitigation Strategies*, The National Academies Press, Washington, D.C., 2010.
67. National Research Council, *New Worlds, New Horizons in Astronomy and Astrophysics*, The National Academies Press, Washington, D.C., 2010.
68. J. Horner, B.W. Jones, and J. Chambers. 2010. Jupiter—Friend or foe? III: The Oort cloud comets. *International Journal of Astrobiology* 9:1-10.

69. A. Sánchez-Lavega, A. Wesley, G. Orton, R. Hueso, S. Perez-Hoyos, L.N. Fletcher, P. Yanamandra-Fisher, J. Legarreta, I. de Pater, H. Hammel, A. Simon-Miller, J.M. Gomez-Forrellad, J.L. Ortiz, E. García-Melendo, and R.C. Puetter. 2010. The impact of a large object with Jupiter in July 2009. *The Astrophysical Journal* 210:L155-L159
70. D.V. Titov, F.W. Taylor, and H. Svedhem. 2008. Introduction to the special section on Venus Express: Results of the nominal mission. *Journal of Geophysical Research* 113:E00B19.
71. S.E. Smrekar, E.R. Stofan, N. Mueller, A. Treiman, L. Elkins-Tanton, J. Helbert, G. Piccioni, and P. Drossart. 2010. Recent hotspot volcanism on Venus from VIRTIS emissivity data. *Science* 328(5978):605-608, doi:10.1126/science.1186785.
72. F. Forget, R.M. Haberle, F. Montmessin, B. Levrard, and J.W. Head. 2006. Formation of glaciers on Mars by atmospheric precipitation at high obliquity. *Science* 311:368-371.
73. G.S. Orton, P.A. Yanamandra-Fisher, B.M. Fisher, A.J. Friedson, P.D. Parrish, J.F. Nelson, A.S. Bauermeister, L. Fletcher, D.Y. Gezari, F. Varosi, A.T. Tokunaga, et al. 2008. Semi-annual oscillations in Saturn's low-latitude stratospheric temperatures. *Nature* 453:196-199.
74. T. Fouchet, S. Guerlet, D.F. Strobel, A.A. Simon-Miller, B. Bézard, and F.M. Flasar. 2008. An equatorial oscillation in Saturn's middle atmosphere. *Nature* 453:200-202.
75. D.F. Strobel, S.K. Atreya, B. Bézard, F. Ferri, F.M. Flasar, M. Fulchignoni, E. Lellouch, and I. Müller-Wodarg. 2009. Atmospheric structure and composition. Pp. 235-257 in *Titan from Cassini-Huygens* (R. Brown, J.P. LeBreton, and J.H. Waite, eds.). Springer, Heidelberg.
76. K.K. Khurana, M.G. Kivelson, K.P. Hand, and C.T. Russell. 2009. Electromagnetic induction from Europa's ocean and the deep interior. Pp. 571-586 in *Europa* (R. Pappalardo, W. McKinnon, and K. Khurana, eds.). University of Arizona Press, Tucson, Ariz.
77. C.F. Chyba. 2000. Energy for microbial life on Europa. *Nature* 403:381-382.
78. H.F. Wilson and B. Militzer. 2010. Sequestration of noble gases in giant planet interiors. *Physical Review Letters* 104:121101.
79. F. Postberg, S. Kempf, J. Schmidt, N. Brilliantov, A. Beinsen, B. Abel, U. Buck, and R. Srama. 2009. Sodium salts in E-ring ice grains from an ocean below the surface of Enceladus. *Nature* 459:1098-1101.
80. J.H. Waite, Jr., W.S. Lewis, B.A. Magee, J.I. Lunine, W.B. McKinnon, C.R. Glein, O. Mousis, D.T. Young, T. Brockwell, J. Westlake, M.-J. Nguyen et al. 2009. Liquid water on Enceladus from observations of ammonia and 40Ar in the plume. *Nature* 460:487-490.
81. R.H. Brown, J.-P. LeBreton, and J.H. Waite. 2009. Overview. Pp. 1-7 in *Titan from Cassini-Huygens* (R. Brown, J.-P. LeBreton, and J.H. Waite, eds.). Springer, Heidelberg.
82. M.R. Showalter and J.J. Lissauer. 2006. The second ring-moon system of Uranus: Discovery and dynamics. *Science* 311:973-977 2006.
83. I. de Pater, H.B. Hammel, S.G. Gibbard, and M.R. Showalter. 2006. New dust belts of Uranus: One ring, two ring, red ring, blue ring. *Science* 312:92-94.
84. S.E. Smrekar, E.R. Stofan, N. Mueller, A. Treiman, L. Elkins-Tanton, J. Helbert, G. Piccioni, and P. Drossart. 2010. Recent hotspot volcanism on Venus from VIRTIS emissivity data. *Science* 328(5978):605-608.
85. M.C. Malin and K.S. Edgett. 2001. Mars Global Surveyor Mars Orbiter Camera: Interplanetary cruise through primary mission. *Journal of Geophysical Research* 106:423429-423570.

4

The Primitive Bodies: Building Blocks of the Solar System

Studies of primitive bodies encompass asteroids, comets, Kuiper belt objects (KBOs), the moons of Mars, and samples—meteorites and interplanetary dust particles (IDPs)—derived from them. These objects provide unique information on the solar system’s origin and early history and help interpret observations of debris disks around other stars. The planetary science community has made remarkable progress over the past decade in understanding primitive bodies (Table 4.1), but important questions remain unanswered.

The study of primitive bodies over the past decade has been accomplished via a number of space missions such as Deep Impact, Stardust, EPOXI, Cassini, and the Japanese Hayabusa spacecraft. Discovery class missions are ideally suited to primitive body research, although larger missions also play a vital role, particularly for objects in the outer solar system that cannot be reached without radioisotope power systems. In the coming decade, several other missions currently underway, such as Dawn and New Horizons, will add substantially to our knowledge of these objects. The study of primitive bodies is also aided by ground-based telescopes and radar, which are highly useful in this field because the number of objects is so great that only a tiny fraction can be visited by spacecraft, and space missions are aided substantially by prior observation. Indeed, ground-based telescopes continue to discover unusual and puzzling objects in the Kuiper belt and elsewhere, and those objects may serve as the targets for future missions.

Comet sample return is a major goal of the study of primitive bodies, and one of the ultimate goals is a cryogenic sample return mission. Such a mission will require technology development initiated in the years before it can begin. Although a flagship class primitive bodies mission is not proposed for this decade, the initiation of a technology development program is necessary for it to be possible in the following decade. New Frontiers class missions can produce valuable science, and the most important missions addressing primitive bodies goals in the coming decade (in priority order) are Comet Surface Sample Return and Trojan Tour and Rendezvous.

Discovery class missions have already produced and will continue to produce important science on these objects. However, a regular, and preferably short cadence for such missions is important. Technology development, laboratory research, and data archiving, are all vital to continued success in the study of primitive bodies. And finally, assured access to large ground-based telescopes is required for observing samples of the large number of primitive bodies in our solar system.

All three of the crosscutting science themes for the exploration of the solar system include the primitive bodies, and studying the primitive bodies is vital to answering a number of the priority questions in each of them. For example, Building New Worlds: “what were the initial stages and conditions and processes of solar system formation and the nature of the interstellar matter that was incorporated?” is largely a question that can only be answered via the study of primitive bodies. The Planetary Habitats theme also includes the question “what were the primordial sources of organic matter, and where does organic synthesis continue today?”—which is also relevant to the study of primitive bodies, because comets are believed to be a primary source of primordial organic materials. Primitive Bodies are also relevant to the Workings of Solar Systems theme. Two of its questions, in particular, directly involve the primitive bodies: First, primitive bodies are central to “what solar system bodies endanger and what mechanisms shield Earth’s biosphere?” because of the role that asteroid and comet

impacts on Earth have played in mass extinction events, and they still pose a modern day hazard. “How have the myriad chemical and physical properties that shaped the solar system operated, interacted, and evolved over time?” is a question that is directly addressed by the study of their role in accretion and subsequent bombardment through time, in particular as these bodies are believed to have served an important role in delivering organic materials and water to the inner planets, particularly Earth.

SCIENCE GOALS FOR THE STUDY OF PRIMITIVE BODIES

The goals for research on primitive bodies for the next decade are twofold:

- Decipher the record in primitive bodies of epochs and processes not obtainable elsewhere,
- and
- Understand the role of primitive bodies as building blocks for planets and life.

DECIPHER THE RECORD IN PRIMITIVE BODIES OF EPOCHS AND PROCESSES NOT OBTAINED ELSEWHERE

Primitive bodies, be they asteroids, comets, KBOs, possibly the martian moons, meteorites or IDPs—are thought to have formed earlier than the planets in the hierarchical assembly of solar system bodies. Because they witnessed, or participated in, many of the formative processes in the early solar nebula, they can provide unique constraints on physical conditions and cosmochemical abundances. Such constraints come, in part, from observations and remote-sensing measurements made from nearby spacecraft. Because we can visit only a small number of the myriad, highly diverse primitive bodies, we must also observe them using Earth-based telescopes. Constraints on nebular processes, as well as absolute dating of events in the early solar system, also come from laboratory analyses of samples of these bodies, whether collected and returned to Earth by spacecraft missions or obtained by the vagaries of celestial mechanics. The least-processed of these samples contain small amounts of tiny presolar grains, whose properties and compositions constrain astrophysical processes that predate the solar system.

TABLE 4.1 Major Accomplishments by Telescopes and Space-based Studies of Primitive Bodies in the Past Decade

Major Accomplishment	Mission and/or Technique
Detailed orbital characterization of an asteroid, including successful landing	Near-Earth Asteroid Rendezvous
Sampled a near-Earth asteroid and returned the sample to Earth; determined that small asteroids can be rubble piles	Hayabusa
Determined the density of a comet nucleus via the first controlled cratering experiment on a primitive body	Deep Impact
Return of comet dust for analysis in terrestrial laboratories	Stardust
First reconnaissance of a possible former trans-Neptune object in the form of Saturn’s distant satellite, Phoebe	Cassini
Discovered that binary objects are common among near-Earth and main belt asteroids and Kuiper belt objects, and that comets occur within the main asteroid belt.	Ground- and space-based telescopes and radar studies

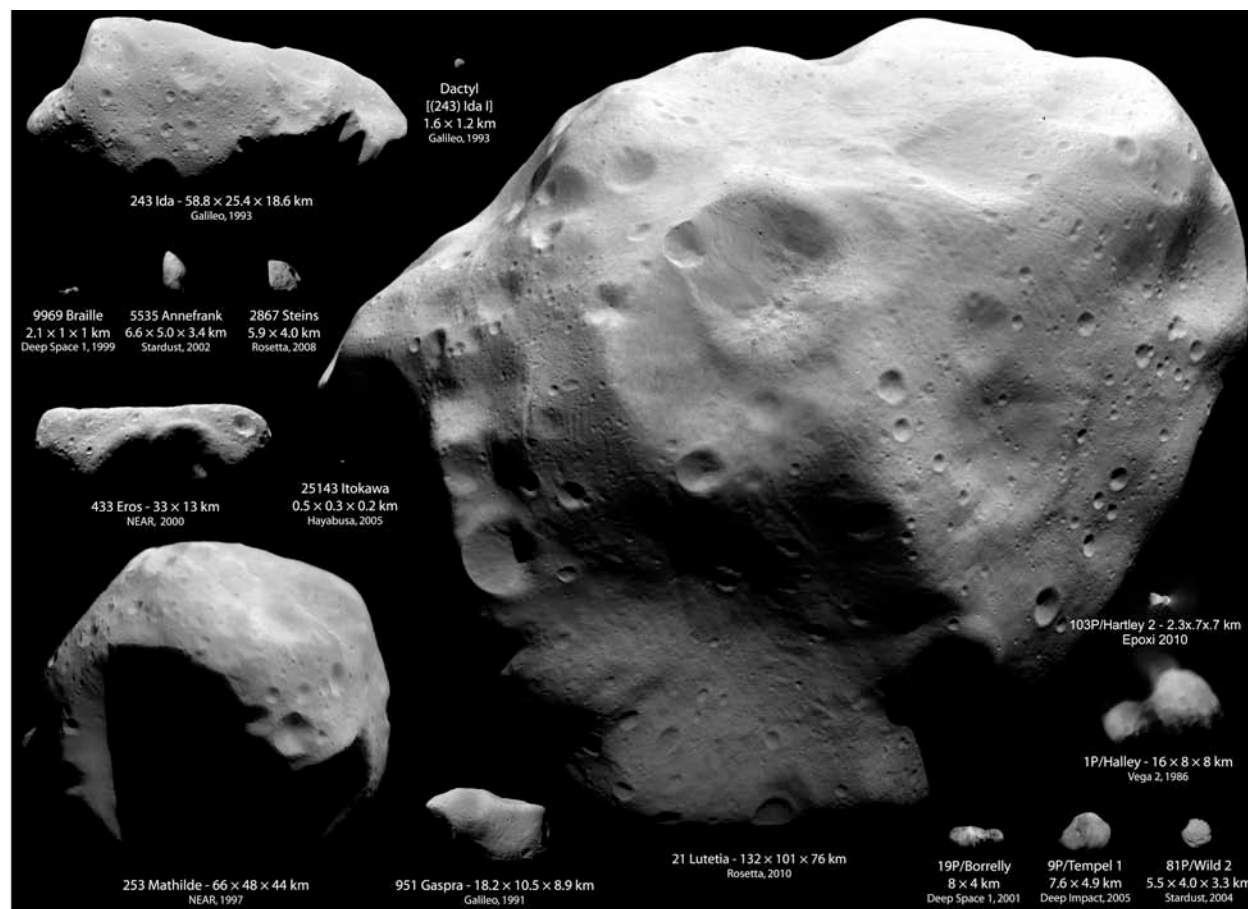

FIGURE 4.1 Asteroids and comet nuclei visited by spacecraft, as of 2010.. SOURCE: *Montage* by Emily Lakdawalla. *Ida*, *Dactyl*, *Braille*, *Annefrank*, *Gaspra*, *Borrelly*: NASA/JPL/Ted Stryk. *Steins*: ESA/OSIRIS team. *Eros*: NASA/JHUAPL. *Itokawa*: ISAS/JAXA/Emily Lakdawalla. *Mathilde*: NASA/JHUAPL/Ted Stryk. *Lutetia*: ESA/OSIRIS team/Emily Lakdawalla. *Halley*: Russian Academy of Sciences/Ted Stryk. *Tempel 1*, *Hartley 2*: NASA/JPL/UMD. *Wild 2*: NASA/JPL.

These processes encompass the inner workings of stars and the formation and modification of materials in the cold reaches of interstellar space.

Specific objectives for continued advancement of this field in the coming decade include the following:

- Understand presolar processes recorded in the materials of primitive bodies;
 - Study condensation, accretion, and other formative processes in the solar nebula;
 - Determine the effects and timing of secondary processes on the evolution of primitive bodies;
- and
- Assess the nature and chronology of planetesimal differentiation

Subsequent sections examine each of these objectives in turn, identify critical questions to be addressed, and suggest future investigations and measurements that could provide answers.

Presolar Processes Recorded in the Materials of Primitive Bodies

Traditionally, the only avenue for understanding processes that predated our own solar system has been astronomical observations. Now, analyses of materials from primitive bodies are revolutionizing this field. Studies of microscopic presolar grains in chondritic meteorites, interplanetary dust particles, and comet samples returned by the Stardust mission provide critical constraints for models of the synthesis of elements and isotopes within stars and supernovae.¹ Characterization studies of organic matter in these materials are proceeding apace; they reveal how simple carbon-based molecules formed in interstellar space have been processed into more complex molecules in the solar nebula and in planetesimals. Isotopic and structural fingerprints in these molecules are allowing us to constrain how and where these molecules formed.

Remarkable progress, enabled by significant advances in micro-analytical technology, has been made in documenting the compositions of presolar grains incorporated into chondrites, and in linking the various kinds of grains to the specific stellar environments in which they formed.^{2,3} Further technological advances will continue to revolutionize our understanding of stellar nucleosynthetic processes. Somewhat surprisingly, comet samples returned to Earth by the Stardust mission were not dominated by presolar grains, suggesting that our understanding of how presolar grains were incorporated into the solar nebula is incomplete.⁴ The challenging measurements of the stable isotopic compositions of specific organic molecules in meteorites and Stardust grains have advanced during this decade.

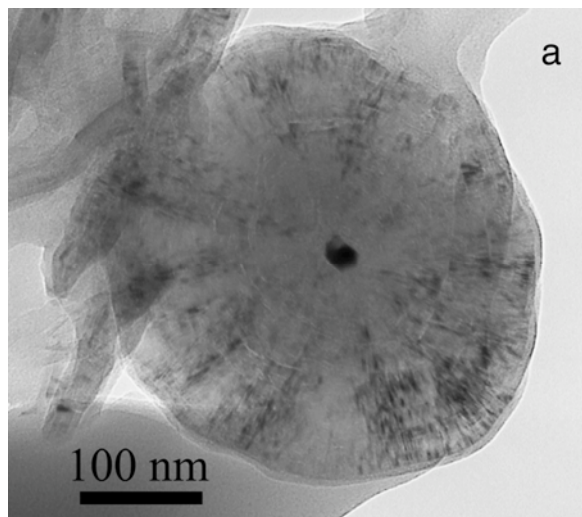

FIGURE 4.2 Transmission electron microscope image of a presolar graphite grain, containing a central core (dark) of titanium-vanadium carbide. This grain formed by condensation around another star.

SOURCE: H.Y. McSween and G.R. Huss, *Cosmochemistry*, Cambridge University Press, 2010, p. 131. Copyright 2010 Cambridge University Press, reprinted with permission.

Important Questions

Important questions for understanding of presolar processes recorded in the materials of primitive bodies include the following:

- How do the presolar solids found in chondrites relate to astronomical observations of solids disposed around young stars?
- How abundant are presolar silicates and oxides? Most of the presolar grains recognized so far are carbon (diamond, graphite) phases or carbides.

- How do the compositions of presolar grains and organic molecules vary among different comets?

Future Directions for Investigations and Measurements

While previous laboratory work has focused on presolar grains extracted from meteorites by harsh chemical treatments, future efforts will exploit new technologies to locate and analyze presolar grains in situ in the host meteorites, so as to identify less refractory materials. Obtaining presolar grains and organic matter from additional comet sampling missions and from interplanetary dust particles will allow us to understand how these materials were distributed in the solar nebula and preserved in solar system solids.

Condensation, Accretion, and Other Formative Processes in the Solar Nebula

Primitive asteroids and the meteorites derived from them were witnesses to events and processes in the inner solar nebula, while comets formed in the outer reaches of the solar system and thus record a broader array of nebular environments. The innermost portions of the nebula were hot, causing interstellar solids to melt, evaporate, and recondense as refractory minerals. The outer portions of the nebula were cold enough to condense ices, profoundly changing the bulk compositions of accreted planetesimals and planets. The thermal and chemical conditions of various nebular regions, the processes that occurred in these regions, the timing of such processes, and the subsequent transport of materials between nebular regions, can all be constrained from studies of primitive body materials. The nature of the accretion process is also revealed by the size distributions of planetesimals whose assembly was arrested before they reached planetary masses.

Significant progress has been made in constraining the nature and mixing during formation, and the formation chronology, of primitive bodies using short-lived radioisotopes.^{5,6} Dynamic nebular mixing is indicated by the diverse components in comet samples returned by the Stardust spacecraft, and the composition of the Sun is now constrained by analyses of solar wind samples from the Genesis spacecraft.⁷ The ¹⁶O-rich isotopic composition of oxygen in the Sun is one of the biggest surprises in cosmochemistry.⁸ Another startling revelation is that melted and differentiated asteroids formed earlier than chondritic asteroids,⁹ implying that the early building blocks for the terrestrial planets were already differentiated.¹⁰ Kuiper belt object size distributions, now moderately well known for bodies greater than 100 km, are serving as our best tracer of the accretion phase in the outer solar nebula.¹¹

Important Questions

Some important questions concerning condensation, accretion, and other formative processes in the solar nebula are as follows:

- How much time elapsed between the formation of the various chondrite components, and what do those differences mean?
- Did evaporation and condensation of solids from hot gas occur only in localized areas of the nebula, or was that widespread?
- What are the isotopic compositions of the important elements in the Sun?
- Which classes of meteorites come from which classes of asteroids, and how diverse were the components from which asteroids were assembled?
- How variable are comet compositions, and how heterogeneous are individual comets?

- What are the abundances and distributions of different classes of asteroids, comets, and KBOs?
- How do the compositions of Oort cloud comets differ from those derived from the Kuiper belt?

Future Directions for Investigations and Measurements

Although progress has been made in assessing whether various kinds of interplanetary dust are derived from comets or asteroids, there remains some uncertainty about the parent objects of some kinds of primitive meteorites. Determining the ages of chondrite components that record specific nebular processes is required to produce a timeline for major events in the solar nebula. Further refinements in analyzing solar wind samples are needed to define isotopic ratios in the Sun. Sampling additional comets is necessary to understand the diversity within this large population of poorly studied primitive bodies. Obtaining comet samples from the surface, as opposed to dust ejected from a comet nucleus, is a high a priority. Increasing the number of known KBOs may reveal the environments in which different classes of objects formed.

Effects and Timing of Secondary Processes on the Evolution of Primitive Bodies

The asteroidal parent bodies of most meteorites have been altered by internal heating, reactions with aqueous fluids (produced by melting accreted ices), and impacts. Telescopic spectral measurements of asteroids indicate that the nature and intensity of alteration differs with orbital position. Secondary processes on primitive bodies control the mineralogy, nature of organic compounds, and volatile element abundances. Abundant meteorite samples have allowed us to quantify the conditions under which these secondary processes occurred and to understand their timing in asteroids. However, the extent of such secondary processes in comets and KBOs is not understood at all.

The conditions and timescales for metamorphism and aqueous alteration in asteroids have been quantified,¹² and considerable progress has been made in modeling asteroid thermal histories.¹³ A consensus has apparently been reached that decay of the short-lived radionuclide ²⁶Al was the primary heat source for asteroids, based on new isotopic analyses of meteorites and its success in thermal evolution models. Recent spacecraft missions to asteroids and comets have documented secondary processes, including extensive impact cratering on asteroid surfaces and smooth flows of erupted materials on comet nuclei¹⁴

Important Questions

Some important questions concerning the effects and timing of secondary processes on the evolution of primitive bodies include the following:

- To what degree have comets been affected by thermal and aqueous alteration processes?
- How well can we read the nebular record in extraterrestrial samples through the haze of secondary processes?
- What is the relationship between large and small KBOs? Is the small population derived by impact disruption of the large one?
- How do the impact histories of asteroids compare to those of comets and KBOs?
- How do physical secondary processes such as spin-up result from non-gravitational forces, the creation and destruction of binary objects, and space weathering?

Future Directions for Investigations and Measurements

Comets and distant KBOs likely record secondary processing under a vast range of conditions; studying such processes will require a combination of telescopic observations and challenging spacecraft missions. Formulation of more realistic thermal models for asteroids and comets is needed.

Nature and Chronology of Planetesimal Differentiation

Melted silicate-metal asteroids and the meteorites derived from them provide information on the formation of crusts, mantles, and cores on bodies with compositions different from Earth and under conditions not encountered on our planet. They allow us to test the generality of hypotheses about the differentiation of planets. From them, we learn how elements are partitioned between molten and solid phases. The radiogenic isotope systems in differentiated meteorites provide the required information to date differentiation processes recorded in samples of Earth, the Moon, and Mars. At the other end of the compositional scale, the Kuiper belt is home to the largest number of silicate-ice objects, some of which it has been suggested may have undergone internal heating and differentiation.

New age dates have revolutionized the chronology of differentiated silicate bodies,^{15,16} while new meteorite recoveries have broadened the range of differentiation styles and conditions experienced by these bodies.¹⁷ The rapid cooling rates determined from nickel diffusion profiles in some iron meteorite groups suggest that glancing impacts may have stripped off their thermally insulating silicate mantles, exposing hot, naked iron cores.¹⁸ Thermal models to explain metal-silicate differentiation in asteroids and silicate-ice differentiation in KBOs have become more sophisticated as more rigorous constraints have been placed on them.^{19,20}

Important Questions

Some important questions concerning the nature and chronology of planetesimal differentiation include the following:

- Did asteroid differentiation involve near-complete melting to form magma oceans, or modest partial melting?
- How did differentiation vary on bodies with large proportions of metal or ices?
- Were there radial or planetesimal-size limits on differentiation, and were KBOs and comets formed too late to have included significant amounts of live ²⁶Al as a heat source?
- What are the internal structures of Trojans and KBOs?

Future Directions for Investigations and Measurements

The Dawn spacecraft will arrive at asteroids Vesta in July 2011 and Ceres in February 2015. Mapping and spectroscopy of Vesta and Ceres will provide new insights into differing styles of asteroid differentiation and set the stage for geophysical exploration of asteroids by spacecraft to determine their interior structures and compositions. Such spacecraft missions can provide ground truth for systematic studies of KBOs with large ground-based telescopes, which might probe the state of differentiation on bodies with a broader range of sizes and dynamical locations.

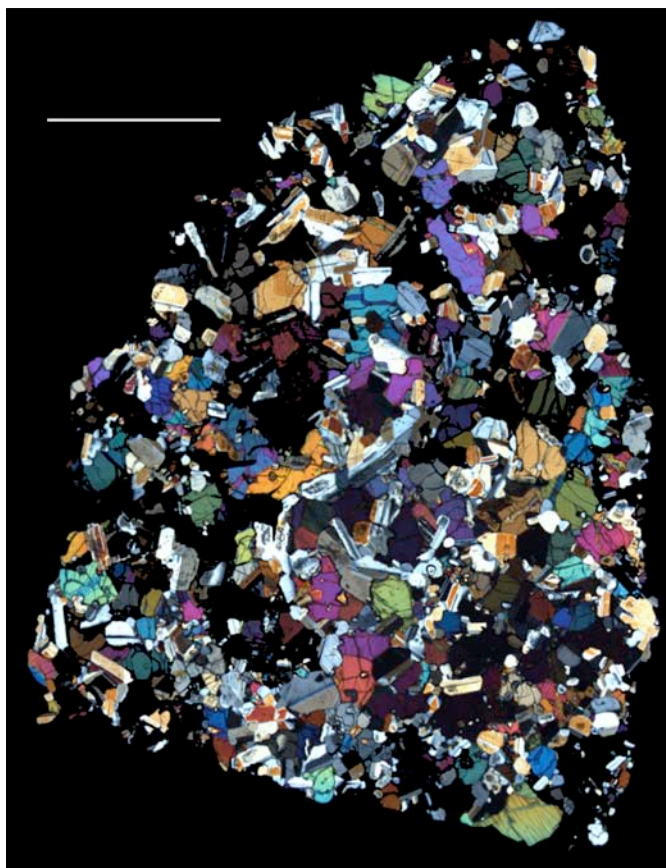

FIGURE 4.3 Photomicrograph of the EET 90020 basaltic eucrite, a differentiated meteorite thought to be derived from asteroid 4 Vesta. The scale bar is 2.5 mm. SOURCE: With kind permission from Springer Science+Business Media: H.Y. McSween, D.W. Mittlefehldt, A.W. Beck, R.G. Mayne and T.J. McCoy, HED meteorites and their relationship to the geology of Vesta and the Dawn mission, *Space Science Reviews*, Online First, doi10.1007/s11214-010-9637-z, Copyright Springer Science+Business Media B.V. 2010.

UNDERSTAND THE ROLE OF PRIMITIVE BODIES AS BUILDING BLOCKS FOR PLANETS AND LIFE

The planets have experienced significant geologic processing, by differentiation to form crusts, mantles, and cores of varying composition, and by subsequent reworking through massive impacts, continued tectonic and igneous activity, and in some cases interactions of the surface with an atmosphere or hydrosphere. No planetary samples now have the chemical composition of the whole, and melting, crystallization, and metamorphism have conspired to modify planetary matter so that its precursor materials are nearly unrecognizable. However, certain chemical and isotopic fingerprints persist, and these can be compared with measurements of meteorites to constrain the kinds and proportions of primitive body planetesimals that accreted to form the planets now dominating the solar system. Although we can infer the interior structures of differentiated planets from geophysical data, differentiated meteorites provide real samples of core and mantle materials for direct analysis. Radiogenic isotopes in meteorites provide the necessary baseline for reconstructing the chronology of planet formation and differentiation. Documenting the orbital distributions and understanding the orbital evolutions of primitive bodies also constrain the dynamics and timing of planetary accretion.

PREPUBLICATION COPY—SUBJECT TO FURTHER EDITORIAL CORRECTION

4-8

Astrobiology is the study of the origin, evolution, and distribution of life in the universe. Although it is unrealistic to look for life on primitive bodies, we know from the study of meteorites that many of them contain the organic ingredients for life. These organic compounds were formed as mantles on dust grains in cold interstellar clouds and in the outer reaches of the solar nebula, and in rocks within the warmed interiors of planetesimals as the ices in these bodies melted. The compounds are surprisingly complex and include amino acids and other molecules that are central to life on Earth. The accretion of such materials, late in the assembly of planets, is thought to have been a possible first step in the poorly understood path from organic matter to organisms. Studies of the molecular forms and isotopic compositions of the organic matter in meteorites and samples returned by spacecraft provide a prebiotic starting point for the origin and evolution of life or an independent channel of abiologic organic chemistry.

Specific objectives for continued advancement of this field in the coming decade include the following:

- Determine the composition, origin and primordial distribution of volatiles and organic matter in the Solar System;
- Understand how and when planetesimals were assembled to form planets; and
- Constrain the dynamical evolution of planets by their effects on the distribution of primitive bodies.

Subsequent sections examines each of these objectives in turn, and identify critical questions to be addressed and future investigations and measurements that could provide answers.

Composition, Origin, and Primordial Distribution of Volatiles and Organic Matter in the Solar System

Meteorites and interplanetary dust particles are readily available sources of extraterrestrial organic matter from asteroids and comets, although the volatile species and organic components of comets and KBOs remain poorly understood. Systematic depletions in highly volatile elements in meteorites testify to an important elemental fractionation in the early solar system, but it is not well understood. Some organic matter in chondrites, interstellar dust particles, and Stardust comet samples has been structurally and isotopically characterized, although the insoluble organic fractions, consisting of huge complex molecules, are extremely difficult to analyze. Understanding the formation and evolution of organic molecules in space and in planetesimals is essential to astrobiology. Telescopic spectral observations of primitive bodies provide at best a tantalizing but incomplete picture of the orbital distribution of organic matter in the early solar system.

The planetary science community has made progress in characterizing the insoluble (macromolecular) organic matter and in analyzing the isotopic compositions of specific organic compounds in chondrites.^{21,22,23} The changes in organic matter caused by parent body alteration are now better understood, and the fractionation of isotopes during the evaporation of volatile elements has been modeled. Cometary organic matter and volatile elements have been analyzed in samples returned by the Stardust spacecraft,^{24,25,26} and cometary volatiles are now recognized to be heterogeneous as determined by the Deep Impact spacecraft.²⁷ Spectroscopy of recently discovered KBOs has provided some constraints on their surface compositions.²⁸ Comparison of meteoritic and cometary organic matter inventories with the composition of young circumstellar disks has been facilitated by recent Spitzer telescope observations.²⁹

Important Questions

Some important questions concerning the composition, origin, and primordial distribution of volatiles and organic matter in the solar system include the following:

- What are the chemical routes leading to organic molecule complexity in regions of star and planet formation?
- What was the proportion of surviving presolar organic matter in the solar nebula, relative to the organic compounds produced locally?
- What roles did secondary processes and mineral interactions play in the formation of organic molecules?
- How stable are organic molecules in different space environments?
- What caused the depletions in volatile elements, relative to chondrites, observed in differentiated asteroids and planets?
- What kinds of surface evolution, radiation chemistry, and surface-atmosphere interactions occur on distant icy primitive bodies?
- How is the surface composition of comets modified by thermal radiation and impact processes?

Future Directions for Investigations and Measurements

The New Horizons spacecraft will fly past Pluto in July 2015 and obtain remote sensing data on the dwarf planet and its satellites Charon, Nix, and Hydra. It is expected that a successful encounter with Pluto will be followed by retargeting the spacecraft to a flyby with a yet-to-be-selected Kuiper belt object. The detailed characterization of a single small system of Kuiper belt objects—Pluto and Charon—and maybe more if suitable candidates can be found along New Horizon’s trajectory will have to be complemented by large ground-based telescope studies in order to continue the discovery and characterization of a significant portion of KBOs. Organic matter in returned comet samples will provide critical new information on organic synthesis. The study of organic matter in extraterrestrial materials will also evolve from basic characterization of simple compounds and mixtures to understanding the origin of different molecules. Return of samples from a range of organic-rich asteroids and comets (including cryogenically preserved comets) will ultimately be required to fully address these questions.

How and When Planetesimals Were Assembled to Form Planets

Planet formation was hierarchical, as small planetesimals were assembled into ever-larger ones, eventually forming the planets. The feeding zones for accretion of planets and the timing of planetary growth remain incompletely understood. Swarms of asteroids, comets, and KBOs provide basic information on planetesimal sizes, compositions, and orbital parameters with which to model the assembly of planets. Studies of radiogenic isotopes in meteorites allow the timing of planet formation to be constrained.

Theoretical studies, particularly complex accretion models developed during this decade follow the orbital evolution of many thousands of objects and provide constraints on the timescales and widths of feeding zones for the terrestrial planets.³⁰ Our understanding of the timing of accretion benefits from improved determinations of the formation chronology of Earth, the Moon, and Mars, which have been made using measurements of short-lived radioisotopes in samples.^{31,32,33}

Important Questions

Some important questions concerning how and when planetesimals were assembled to form planets include the following:

- Are there systematic chemical or isotopic gradients in the solar system, and if so, what do they reveal about accretion?
- Do we have meteoritic samples of the objects that formed the dominant feeding zones for the innermost planets?
- How did Earth get its water and other volatiles? What role did icy objects play in the accretion of various planets?
- What is the mechanical process of accretion up to and through the formation of meter-size bodies?

Future Directions for Investigations and Measurements

Understanding the formation times of the various materials that comprise comets could constrain the chronology of km-sized objects beyond the orbit of Neptune. Measurements of deuterium/hydrogen in different primitive objects can be used to constraint their possible contributions to the water inventory of Earth and other planets. Determining the deuterium/hydrogen ratio in multiple comets would quantify the role they may have played in delivering water and organic matter to the early Earth. Spacecraft exploration of multiple asteroids could provide information on compositional gradients in the solar system. Improvements in numerical models for accretion could provide a more robust understanding of feeding zones.

Dynamical Evolution of Planets by their Effects on the Distribution of Primitive Bodies

The orbital distribution of the giant planets is now thought to have been much more dynamic than previously appreciated. Orbital perturbations of primitive bodies are the key to unraveling planet migrations in the early solar system. Although pathways from the main belt to account for near-Earth asteroids are now clear, the source of some asteroid populations, such as Trojans (in orbits near Jupiter) and Centaurs (in orbits between the asteroid belt and the Kuiper belt) is not understood. The Kuiper belt is an important reservoir of comets, although the precise delivery paths into the inner solar system remain unclear.

Bodies exhibiting cometary activity have now been recognized within the main asteroid belt and among the Centaur asteroids.³⁴ The structure of the Kuiper belt provides one of the best constraints on the dynamical rearrangement of the giant planets, and some recent KBO studies have revised scenarios for the early orbital history of the solar system.³⁵ The size distribution of main belt asteroids has been matched to that of impactors during the late heavy bombardment about 4 billion years ago, suggesting that the asteroid belt was the source of these impactors.^{36,37} A different population of impactors is indicated for the outer solar system judging from the cratering record preserved on Saturn's ice satellites.³⁸

Important Questions

Some important questions concerning the dynamical evolution of planets by their effects on the distribution of primitive bodies include the following:

- Which classes of asteroids participated in the late heavy bombardment of the inner planets and the Moon, and how did the current population of asteroids evolve in time and space?
- What are the sources of asteroid groups (Trojans and Centaurs) that remain to be explored by spacecraft?
- How are objects delivered from the Kuiper belt to the inner solar system? Specifically, by what mechanisms are Jupiter family comets resupplied to the inner solar system?

Future Directions for Investigations and Measurements

Determining the orbits of vast numbers of KBOs presents an unprecedented opportunity to reconstruct the early dynamic history of the solar system. Orbital surveys coupled with determination of physical characteristics can constrain physical conditions in the nebula. Missions to Trojan or Centaur objects could provide information on their sources, as well as basic characterization and are important goals for the future.

INTERCONNECTIONS

To Other Parts of the Solar System

Mixtures of meteorite chemical compositions are commonly used to construct models of the bulk compositions, volatile inventories, and oxidation states of the terrestrial planets. Radioactive isotopes in meteorites provide the necessary foundation to construct timescales for planet formation. Differentiated asteroids and iron meteorites provide insights into core formation in the terrestrial planets. Resolving the debate concerning the compositions (and likely origins) of the martian moons Phobos and Deimos may be relevant to understanding the early history of Mars. The orbital distributions of primitive bodies constrain models for the orbital migrations of the giant planets in early solar system history. Cosmic element abundances, determined in part from chondritic meteorites, provide a baseline for comparison with the atmospheric compositions of Jupiter and Saturn. Prebiotic chemistry, as understood from organic matter in primitive bodies, is a starting point for life on Earth and for the study of astrobiology.

To Extrasolar Planets

Studies of the sizes, orbital distributions, and compositions of the KBO population and of interplanetary dust derived from KBOs, comets, and asteroids provide critical data for interpreting accumulating data on debris disks around stars such as Beta Pictoris and Fomalhaut.

Other

The isotopic compositions of presolar grains in meteorites and interplanetary dust particles provide tests of theoretical models of nucleosynthesis in stars and supernovae, which are of great interest to astrophysics. The mineralogy and physical properties of presolar grains also are useful in interpreting astronomical observations of dust in the interstellar medium. The measured abundances of short-lived radionuclides in meteorites reflect the formation of our Sun in the vicinity of high-mass stars that injected supernova materials into the nebula, in agreement with astronomical observations of star-forming regions. The discovery of chondrules and refractory inclusions in comet material returned by the Stardust mission has motivated models of large scale mixing in dust disks. The Kuiper belt offers a model for telescopic

observations of the outer parts of dust disks. The existence of the Oort cloud has motivated searches for analogous comet clouds around other stars.

SUPPORTING RESEARCH AND RELATED ACTIVITIES

Research and Analysis

The ultimate goal of NASA's research and analysis (R&A) programs is to support NASA's space exploration missions. Scientific and technical advances derived from these programs are used to identify important goals for future exploration, determine the most suitable targets for space missions, refine the instrumental and analytic techniques needed to support these missions, assure that the greatest benefit is derived from data returned by past and ongoing missions, and through the direct involvement of students and young investigators, to help train future generations of space scientists and engineers.

The exploration of primitive bodies is fundamentally dependant on a strong supporting R&A program. There are too many asteroids, comets and KBOs to explore individually by spacecraft. Mission choices and target selection must be based on a comprehensive assessment of all available information. The science return from such missions is often enriched by the results of ongoing laboratory studies of meteorites and inter-planetary dust and by complementary telescopic and Earth-orbital measurements. The full interpretation of spacecraft data requires information on the spectral properties of rocks, ices and organic matter under conditions characteristic of primitive body environments, information that continues to be derived from laboratory and theoretical work supported by R&A funding. Additional theoretical and laboratory simulations are essential to plan experiments and interpret the results from them; a recent important example is the impactor experiment on the Deep Impact mission to Comet Tempel 1.

Over the past decade the National Science Foundation has supported a number of programs essential to the study and understanding of primitive bodies. NSF provides funding for field parties to collect meteorites through the U.S. Antarctic Meteorite Program. Over the past decade, more than 8000 new specimens have been recovered. This program continues to be extremely important to all areas of meteorite research. Among the more interesting specimens collected are the largest group of pallasites from Antarctica; unusual paired achondrites that sample the plagioclase-rich crust of an oxidized asteroid and representing a style of volcanism not otherwise sampled in the meteorite record; a new group of unbrecciated lunar mare basalts; a large martian nakhlite; and carbonaceous chondrites that may contain some of the most primitive meteoritic organic matter.

INSTRUMENTATION AND INFRASTRUCTURE

The return of a cryogenic sample from a comet will enable science that can be accomplished in no other way and represents the highest priority mission objective for studying primitive bodies. A subsurface sample from an original ice-bearing region of a comet could provide the most primitive material available in the solar system. Returning the sample to Earth permits the most detailed possible study of the material down to the scale of individual atoms, with precision and accuracy far beyond the capability of instruments on spacecraft. To achieve this, the capability will have to be developed to acquire samples from 0.2 to 1 meter below the surface of a comet.

The return of these samples to Earth is challenging because they contain volatiles at cryogenic temperatures. Ideally, comet sample return missions should preserve samples at or below 150 K from collection to delivery at the curation facility.

While there is no substitute for the science that can be performed in terrestrial laboratories on samples from primitive bodies, significant science at considerably less cost can be performed by in situ investigations. As an important adjunct to sample return, NASA could develop the capability to perform

in situ determination of the stratigraphy, structure, thermodynamic state, chemical, and isotopic composition of subsurface materials on asteroids and comets.

The acquisition of major laboratory instruments often involves joint funding by NSF and NASA. Such cooperative arrangements have proven very beneficial. Such coordination offers a unique opportunity to leverage funds and strengthen infrastructure support.

Earth-Based Telescopes

Earth-based telescopic observations are the primary means of studying the large populations of primitive bodies. Following discovery and orbit determination, telescopic data can probe an object's shape and size, mineralogy, orbital and rotational attributes, presence of volatiles, and physical properties of the surface material including particle size and porosity. These data can motivate scientific goals for future planetary science missions, provide context within which to reduce and analyze spacecraft data, and expand the scientific lessons learned from spacecraft observations to a much larger suite of small solar system bodies.

The 3-meter NASA Infrared Telescope Facility (IRTF) has provided significant data for studies of primitive bodies. The IRTF continues to be relevant to the study of larger or closer objects. Observations of distant objects are, however, constrained by IRTF's modest aperture. Extending the frontiers of knowledge for primitive bodies in the distant regions of our solar system will require more powerful telescopes and significant access to observing time. NASA-provided access to the Keck telescope continues to yield important new data, but the meager number of available nights each year is barely adequate for limited single-object studies and completely inadequate for large-scale surveys. Space-based infrared telescopes cannot operate within specific avoidance angles around the Sun, precluding certain essential studies of comets or inner-Earth asteroids. Access to large Earth-based telescopes will continue to be needed to acquire such observations.

The Arecibo and Goldstone radar telescopes are powerful, complementary facilities that can characterize the surface structure and three-dimensional shapes of the near-Earth objects within their reach of about one-tenth of the Earth-Sun distance. Arecibo has a sensitivity 20 times greater than Goldstone, but Goldstone has much greater sky coverage than Arecibo. Continued access to both radar facilities for the detailed study of near-Earth objects is essential to primitive bodies studies.

The large number of primitive bodies in the solar system requires sufficient telescope time to observe statistically significant samples of these populations to expand scientific knowledge and plan future missions. Characterization of this multitude of bodies requires access to large ground-based telescopes as well as to the Goldstone and Arecibo radars. The Arecibo radio telescope is essential for detailed characterization of the shape, size, morphology and spin dynamics of NEOs that make close approaches to Earth. These radar observations also provide highly accurate determinations of orbital parameters for primitive bodies critical to modeling and planning future exploration.

The recent astronomy and astrophysics decadal survey endorsed the Large Synoptic Survey Telescope (LSST) project as its top-rated priority for ground-based telescopes for the years 2011-2021.³⁹ In addition to its astrophysics science mission, the LSST will have a profound impact on our knowledge of our solar system by providing a dramatic increase in the number of known objects across all dynamical types such as near-Earth and main-belt asteroids, KBOs, and comets. The NRC has outlined observations with a suitably large ground-based telescope as one option for completion of the George E. Brown NEO survey of objects 140 meters diameter or greater in size.⁴⁰ The LSST will allow major advances in planetary science by dramatically extending inventory of the primitive bodies in the solar system. Additional material on LSST, the Panoramic Survey Telescope and Rapid Response System (PanSTARRS), and NEO surveys can be found in Chapter 10.

Sample Curation and Laboratory Facilities

Curation is the critical interface between sample return missions and laboratory research. Proper curation has maintained the scientific integrity and utility of the Apollo, Antarctic meteorite, and cosmic dust collections for decades. Each of these collections continues to yield important new science. In the past decade, new state-of-the-art curatorial facilities for the Genesis and Stardust missions were key to the scientific breakthroughs provided by these missions. In the next decade, opportunities to sample asteroids and comets would provide additional important information. These missions present new challenges, including curation of organics uncontaminated by Earth's biosphere and volatiles requiring low-temperature curation and distribution. The returned samples will require specialized facilities, the funding for which, including long-term operating costs, cannot realistically come from an individual mission budget. In addition to these facilities, expert curatorial personnel are required. Funding for hiring and training the next generation of curatorial personnel is essential.

Laboratory instrumentation is a fundamental part of a healthy primitive bodies program. Spectral and physical data from missions can only be understood fully in the context of laboratory analog measurements. Samples returned by missions require state-of-the-art instrumentation for complete analysis. Significant progress has been made in the last decade, with the initiation of the Laboratory Analysis for Returned Samples program to support laboratory equipment development, construction and operation. This funding was particularly critical to the success of the Genesis and Stardust missions and represents the first laboratory equipment funding directly linked to missions since Apollo.

Technology Development

Currently, the principal obstacles to conducting certain missions to primitive bodies are the absence of the necessary power and propulsion technologies. A rendezvous with a KBO, Centaur, or trans-Neptune object would be a scientifically compelling mission if the appropriate power and propulsion technologies make such a mission possible.

Mating electric propulsion to advanced power systems would permit a wide range of primitive body missions to be undertaken throughout the solar system. One KBO rendezvous mission study considered the use of NASA Evolutionary Xenon Thrusters (NEXT), powered by Advanced Stirling Radioisotope Generators (ASRGs). With these technologies, an orbital rendezvous could be achieved with a KBO at 33 AU from the Sun using an existing launch vehicle with a flight time of 16 years. Another study considered a long-life Hall electric thruster which, when combined with 150-W ASRGs enabled a New Frontiers-class mission to place a scientifically comprehensive payload in orbit around a Centaur object within 10 years of launch using an existing launch vehicle.

Sample return missions from comets and asteroids provide important information on primitive bodies. Such missions require sample return capsules that must withstand Earth-entry velocities of greater than 13 kilometers per second, beyond the capability of current lightweight thermal protection system (TPS) materials. The development and qualification of new low-density TPS materials is essential to reduce the mass of entry capsules and increase science payloads. Several white papers submitted to the committee suggested that return capsules be instrumented in an effort to understand their performance margin in order that future missions can be lower in mass without taking additional risk. Funding TPS development now would leverage the experience and expertise of people who developed the original TPS technologies before they retire.

Specific technology developments necessary to enable a Cryogenic Comet Sample Return (CCSR) mission are outlined separately later in this chapter.

In order to enable a broad range of primitive bodies missions in the near future, technology developments are needed in the following key areas: ASRG and thruster packaging and lifetime, thermal protection systems, remote sampling and coring devices, methods of determining that a sample contains

ices and organic matter and preserving it at low temperatures, and electric thrusters mated to advanced power systems.

ADVANCING STUDIES OF THE PRIMITIVE BODIES: 2013-2022

To date there have been no flagship missions to primitive bodies and none was identified in the previous planetary decadal survey. However, the European Space Agency launched Rosetta in March 2004, a flagship-class mission in which there is modest participation by NASA-sponsored investigators. In addition to participation by U.S. investigators in several of Rosetta's investigations, two of the Rosetta instruments (ALICE and MIRO) were provided by NASA and have U.S. principal investigators. Rosetta is operating successfully and is scheduled to begin its comprehensive investigation of Comet Churyumov-Gerasimenko in 2014.

Flagship-class missions will be necessary to address some key goals for primitive bodies. One example is a Cryogenic Comet Sample Return (CCSR) that would return materials sampled from different depths—up to perhaps 1 meter—from a comet nucleus and preserve those samples at the required cold temperatures to prevent alteration of the sample in transit to Earth.

New Frontiers missions can address most (but not all) major primitive bodies goals. The very first mission of this program—New Horizons—is on its way to Pluto having completed a highly successful flyby of Jupiter in 2007. New Horizons is scheduled to fly past Pluto and its satellites—Charon, Nix, and Hydra—in June 2015 and then proceed to an encounter with a yet-to-be-determined KBO.

The last planetary decadal survey and a subsequent NRC report identified several high priority primitive-body missions within the New Frontiers envelope—the highest priority being a Comet Surface Sample Return (CSSR).⁴¹ Also identified were a Trojan/Centaur Flyby and an asteroid surface rover/sample return. None of these missions have flown or been approved for flight to date.

New Missions

While flagship missions are important to planetary exploration, it is important to maintain balance among mission size, complexity, and targets.

To date, most flagship missions have cost \$2 billion or more. A mission at this scale is not being proposed for the current decade. A more appropriate use of limited resources is the development of technology for a flagship mission in the 2020s.

Future Candidates and List of Technology Needs

Cryogenic Comet Sample Return (CCSR) is viewed as an essential goal, enabled by a precursor Comet Surface Sample Return, as documented by the community's white papers. To make this mission feasible in the 2020s requires the development and demonstration of several key technologies, including the following:

- Sampling the subsurface of a comet to a depth of between 20 cm and 1 m while preserving stratigraphy;
- Developing a reliable in situ method (preferably simple) of determining that the sample contains at least 20% by volume of volatile ices and some fraction of organic matter; and
- A method of preserving the sample at temperatures no higher than 125 K during the transfer from comet to terrestrial laboratory.

In the previous decadal survey, CCSR was not advocated because of the immaturity of critical technology. To enable a CCSR mission that can be carried out at acceptable cost and risk certain critical technologies must be perfected.

The Applied Physics Laboratory undertook a study at the committee's request to identify the technological issues that need to be addressed in order to facilitate a CCSR mission (Appendix G). The report concluded that it should be possible to obtain a stratigraphy-preserving core sample at least 25 cm deep and 3 cm across using a touch and go approach which does not require an actual landing on, or anchoring to, the comet's surface. Also studied were potential approaches to "sample verification," the goal of which is to guarantee that the sample contains at least 20% ice and accompanying volatile organics. A key element of the study was to consider methods of encapsulating the sample and to assess the relative difficulty/cost of maintaining the sample at 90 K, 125 K or 200 K from collection to delivery to a terrestrial laboratory. The study concluded that a practical thermal design is feasible with the storage temperature required to preserve water ice during the expected long cruise phase being about 125 K. In this case the integrity of more volatile ices such as hydrogen cyanide and carbon dioxide would be compromised, unless a temperature of no more than 90 K was maintained. The study indicates that achieving this lower temperature would have significant impacts on the complexity and cost of the mission. On the other hand, relaxing the minimum temperature limit to 200 K appears to be unnecessary to reduce cost.

The report concluded with a technology development roadmap outlining seven important questions that need to be addressed to make CCSR a practical mission in the decade of the 2020s.

A Cryogenic Comet Sample Return mission is of great importance to the study of primitive bodies. However, this mission cannot be achieved without substantial technology development. NASA will have to conduct technology development and demonstration in this coming decade in order to make it possible for the next decade.

Priority New Frontiers-class Missions

Competitively selected missions provide the optimum avenue for fostering innovation and new ideas and for making flight opportunities available to a wider spectrum of investigators. Successful New Frontiers concepts will have focused objectives and well-integrated science and flight teams, aspects which lead to reduced cost and lower risk of cost growth. An experienced PI can assure that these goals are achieved while maximizing science return. Important examples of New Frontiers missions are the Comet Surface Sample Return and the Trojan Tour and Rendezvous.

Comet Surface Sample Return

It is widely believed that active comets contain the best-preserved samples of the initial rocky, icy and organic materials that led to the formation of planets. A Comet Surface Sample Return (CSSR) mission is of the highest priority to the primitive bodies community. A study of this mission, commissioned by NASA and published in 2008, served as a concept study for this decadal survey. The objective of the CSSR mission is to collect at least 100 grams of surface material and return it for analysis to Earth.⁴²

The Stardust mission returned the first samples from a known primitive body and the analysis of these samples has profoundly changed our understanding of the formation of comets. The materials collected by Stardust indicate that comets contain significant amounts of inner solar system materials including chondrules and refractory inclusions. It appears that comets are made of materials that formed across the full expanse of the solar nebula and thus are bodies that are far more important preservers of early solar system history than previously believed. Stardust collected hundreds of particles but most of them were small and the high-speed capture process degraded organics, submicron grains and the surface layers of larger grains.

The CSSR collection can greatly improve on Stardust by returning a large well-preserved sample from a second comet. It can return 100,000 times larger total sample mass that will not be altered during collection, except for compounds that are unstable above room temperature. The sample will include large numbers of 0.1-1 mm solid components that are critically important because they can be compared in exacting detail with their meteorite/asteroid counterparts in regard to elemental composition, mineralogy, isotopic composition and even age. Analysis of the samples will provide an unprecedented look at the formation, distribution and timing of planetary building blocks in the solar nebula. CSSR will provide a large sample of non-volatile cometary organic material that can be compared with the organic material from primitive meteorites that formed in the inner solar system.

The CSSR mission will be a quantum leap beyond Stardust and will expand in significant ways on the compositional data expected from the surface science expected from ESA's flagship mission Rosetta. Deep Impact demonstrated that the nucleus of comet Tempel 1 provides suitable areas for sampling of the sort envisioned for a CSSR mission: kilometer-scale areas which are smooth at decimeter scale and have mechanical properties that might be similar to those of loose sand. Moreover, the Comet Surface Sample Return is an important precursor for the Cryogenic Comet Sample Return mission, because it will provide information on the state of fine- and coarse-grained aggregates and organic matter which, along with ices, control the bulk physical properties of materials to be collected.

Trojan Tour and Rendezvous

Trojan asteroids, at the boundary between the inner and outer solar system, are one of the keys to understanding solar system formation. While they were originally thought to have been captured from the outer parts of the asteroid belt, new theories have proposed that they were instead captured from the Kuiper belt during a phase of extreme mixing of the small bodies of the solar system. In depth study of these objects will provide the opportunity to understand the degree of mixing in the solar system and to study the composition and physical characteristics of bodies that are among the most primitive in the solar system.

A mission to rendezvous with a Trojan asteroid after flying by several Trojan asteroids would provide elemental and mineralogical composition of the surface materials, physical state of the surface regolith, and geology of the surface including surface structures. Information on the interior structure of a Trojan can be obtained from shape determination and radiometric tracking. The rendezvousing spacecraft would be equipped with instruments to study reflectance spectral properties over a wavelength range of 0.25–5.0 μm , gamma-ray and neutron spectroscopy to elucidate elemental composition, multispectral imaging, an ultraviolet spectrometer to search for outgassing, a thermal mapper, and possibly a LIDAR. Most of these instruments would provide important data during the flybys on the way to the rendezvous.

Future Candidates and List of Technology Needs

The committee commissioned several studies of potential primitive bodies missions that were not selected for prioritization, but could form the basis for future missions. These missions included the following:

- Asteroid Interior Composition Mission, and
- Chiron Orbiter

Asteroid Interior Composition Mission

This study considered the use of a spacecraft to perform geophysical investigation of a main belt asteroid. The mission's primary goal would be to understand the internal structure of a differentiated

asteroid (either ice-rock or metal-silicate differentiation) with a secondary objective of measuring surface chemistry and mineralogy. Asteroids 4 Vesta and 6 Hebe were both considered as potential targets. A solar-electric propulsion mission to 4 Vesta was favored, with delivery of seismometers and explosive charges as activators via penetrators. Although the mission design achieved the primary objective, there remained significant risks both in penetrator design and in incorporating mineralogical and/or chemical instrumentation in penetrators and the committee chose to terminate the study prior to its completion.

Technology development of integrated penetrator systems would enable science beyond the next decade: first, by reducing risk due to operational uncertainties owing to, for example, penetrators burial in material of unknown strength and cohesion; second, by enabling science through critically evaluating the ability of complementary instruments to withstand the forces inherent to penetrator deployment.

Chiron Orbiter

The committee found that an orbiter of the Centaur Chiron would provide a rich scientific return and yield important information about this class of primitive objects. A study carried out by Goddard Space Flight Center (Appendixes D and G) found that with current propulsion technology it is not feasible, within the New Frontiers program, to place in orbit an adequate scientific payload (e.g., an imager, ultraviolet and infrared spectrometers, a magnetometer, and a radio science experiment). Possible options for missions to Okryhoe and Echeclus were found, but these Centaurs have not yet been studied adequately to make them compelling.

The study also looked for technological advances that could enable a mission to Chiron that would be sufficiently comprehensive to answer the most basic questions about the nature and behavior of Centaurs. The best option requires more efficient packaging of ASRGs for higher-power systems and ion thrusters rated for long mission lifetimes and larger integrated thrust. More capable propulsion systems will have to be developed before scientifically rewarding rendezvous investigations of Chiron and other targets of high scientific interest in the outer solar system are possible.

Given the growing number of known Centaurs and KBOs, the committee concluded that it is scientifically desirable that missions directed to the outer solar system take advantage of opportunities to fly by such objects (at ranges less than 10,000 km) en route to their ultimate targets. During the next decade there will be a growing desire to investigate some large trans-Neptune objects beyond the orbit of Pluto. The New Horizons mission already en route to Pluto has the potential to fly by a small KBO. This extended mission opportunity will be a first chance for a close-up view of this class of object and should not be missed if a suitable target is available (Figure 4.4).

From the perspective of primitive bodies, New Frontiers and Discovery (Box 4.1) missions are both critically important and a reasonable cadence of such missions must be maintained. Flagship missions are important but they cannot be allowed to consume all the resources of the planetary exploration program, especially when smaller missions are still capable of returning valuable science.

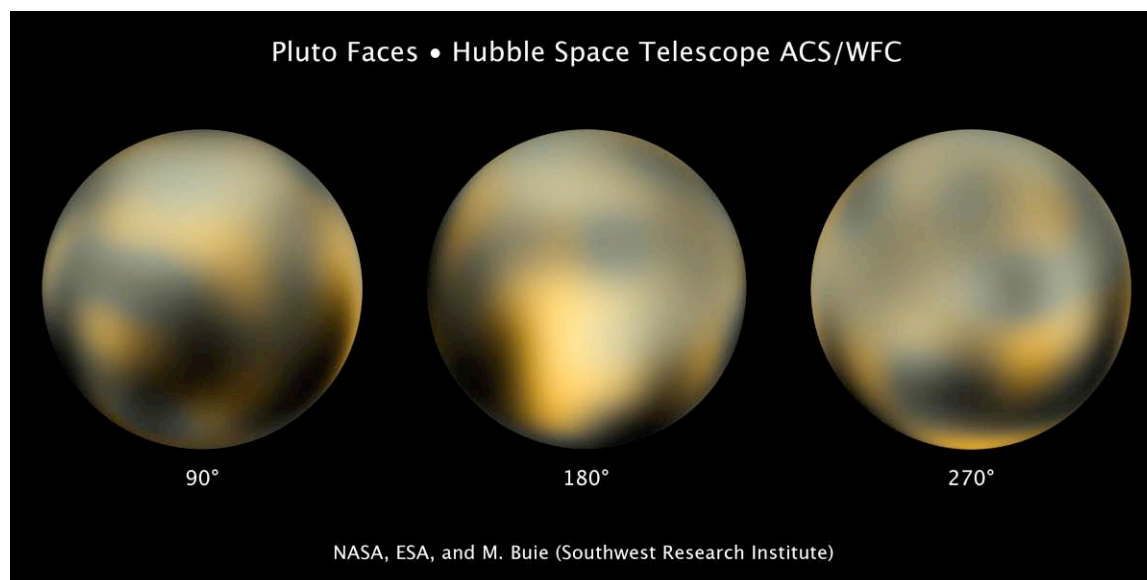

FIGURE 4.4 The current best map and images of Pluto based on data from the Hubble Space Telescope. This will be the best view possible until the arrival of the New Horizons mission in 2015. NOTE: This figure was part of a NASA-sponsored press release in March 2010. It is based on results published in *Astronomical Journal* 139:1128-1143, 2010, and *Astronomical Journal* 139:1117-1127, 2010. SOURCE: NASA, ESA, and M. Buie (Southwest Research Institute).

Missions of Interest to NASA's Exploration Systems Mission Directorate

Although NASA's plans for human exploration activities beyond low Earth orbit are in flux, there is considerable interest in missions to near-Earth objects. Thus, precursor robotic missions to small bodies can accommodate both human exploration and science goals. Potentially significant areas of overlapping interest between SMD and ESMD include the following:

- Identification of hazards requires an understanding of the geophysical behavior of NEOs, a science goal;
- Development of technologies, especially advanced power systems, for human-precursor missions are similar to those required for science missions; and
- Resource identification encompassing scientific compositional measurements.

The Lunar Reconnaissance Orbiter provides a recent demonstration of synergy between the interests of NASA's SMD and ESMD. Proximity operations around small bodies may allow some science observations, and eventual human landings on small bodies would presumably involve sample returns. Such interaction might include a spectrum of opportunities, including providing inputs into mission design, furnishing flight instruments, characterizing objects through data analysis, and sharing newly developed technologies.

Because of their proximity, NEOs are obvious targets for low-cost scientific reconnaissance, rendezvous, and sample return. Notional ESMD plans include several missions to NEOs. Many of these objects, in diameter ranges of ~100 meters to a few tens of kilometers, have been well characterized by ground-based astronomy. Those that come very close to Earth (the so-called Potentially Hazardous Asteroids) have occasionally been extremely well characterized by optical instruments and by radar observations from Goldstone and Arecibo, and are of great societal interest on account of their potential

PREPUBLICATION COPY—SUBJECT TO FURTHER EDITORIAL CORRECTION

4-20

hazard. Asteroid 433 Eros, one of the largest NEOs, has been visited by a low-cost Discovery rendezvous mission (Near-Earth Asteroid Rendezvous-Shoemaker), and one of the asteroids most accessible by spacecraft (25143 Itokawa) was visited by the Japanese Hayabusa sample-return mission. Delivered to near-Earth space from the main belt and more distant reservoirs, NEOs encompass a stunning variety of taxonomic types, sizes and histories representative of the solar system at large, including a fraction of extinct comets. Future missions may take advantage of low- ΔV trajectories to visit bodies of more uncommon and primitive spectroscopic type, both to study them geologically and to return samples of such compositions that are unlikely to be represented by meteorites.

Notional ESMD robotic precursor mission to Mars have also been discussed. There has been little mention of missions to the martian moons, Phobos and Deimos. It is clear that these two moons could play important roles in the future exploration of Mars, especially if they turn out to be related to volatile-rich asteroids, a possibility which has not been excluded by existing data and observations. If so, they may be the surviving representatives of a family of bodies that originated in the outer asteroid belt or further, and reached the inner solar system to deliver volatiles and organics to the accreting terrestrial planets.

Investigation of Phobos and Deimos crosscuts disciplines of planetary science including the nature of primitive asteroids, formation of the terrestrial planets, and astrobiology. Key science questions are the moons' compositions, origins, and relationship to other solar system materials. Are the moons possibly re-accreted Mars ejecta? Or are they possibly related to primitive, D-type bodies?

These questions can be investigated by a Discovery-class mission that includes measurements of bulk properties and internal structure, high-resolution imaging of surface morphology and spectral properties, and measurements of elemental and mineral composition. A possible follow-up New Frontiers-class sample return mission could provide more detailed information on composition. Because Phobos and Deimos are potential staging areas and sources of resources for future human exploration of Mars, missions to Phobos and Deimos would contribute to human exploration in a way unique among missions to primitive bodies.

Summary

The scientific study of primitive bodies can be advanced during the next decade if the following activities are addressed:

- *Flagship Missions*—A mission at this scale is not proposed for the current decade. A more appropriate use of limited resources is the initiation of a technology program focused on assuring that a Cryogenic Comet Sample Return mission can be carried out in the decade of the 2020s at acceptable cost and risk.
- *New Frontiers Missions*—Raise the cost cap of the New Frontiers program and keep New Frontiers as PI-led missions. The independent cost estimates for primitive body missions (Appendix C) indicate that the current cost cap for New Frontiers is insufficient for missions of the highest interest. The most important missions addressing primitive body goals during the coming decade are, in priority order:
 1. Comet Surface Sample Return and
 2. Trojan Tour and Rendezvous.
- *Discovery Missions*—Ensure an appropriate cadence of future Discovery missions. This is critical to the exploration of primitive bodies (Box 4.1), because of the large number of interesting targets. A regular, preferably short cadence, is more important than increasing the cost cap for Discovery missions.
- *Technology Development*—Expand technology developments in the following areas that affect the highest ranked missions to primitive bodies: ASRG and thruster packaging and lifetime,

PREPUBLICATION COPY—SUBJECT TO FURTHER EDITORIAL CORRECTION

thermal protection systems, remote sampling and coring devices, methods of determining that a sample contains ices and organic matter and preserving it at low temperatures, and electric thrusters mated to advanced power systems. Develop a program to bridge the TRL 4-6 development gap for flight instruments to assure that state of the art instrumentation is available for primitive body missions of the future.

- *Ground-based Telescopes*—Assure access to large telescopes and the LSST for planetary science observations and maintain the capabilities of the Goldstone and Arecibo radar systems. The large number of primitive bodies in the solar system requires sufficient telescope time to observe statistically significant samples of these populations to expand our scientific knowledge and plan future missions. Characterization of this multitude of bodies requires large ground-based facilities.

- *Laboratory Research*—Continue funding of programs to analyze samples of primitive bodies in hand and develop next-generation instruments for laboratory analyses of returned samples from comets and asteroids.

- *Data Archiving*—Support the ongoing effort to evolve the Planetary Data System from an archiving facility to an effective online resource for the NASA and international communities.

- *Data Curation*—It is essential to maintain current sample curation facilities and expand their capabilities to handle comet nucleus samples anticipated from the CSSR and CNSR missions.

These mission priorities, research activities, and technology development initiatives will be assessed and prioritized in Chapters 9, 10 and 11, respectively.

BOX 4.1 The Discovery Program, Vital to Exploring Primitive Bodies

The Discovery program continues to be an essential part of the exploration and scientific study of primitive bodies. Significant breakthroughs in our understanding of comets and asteroids can be attributed directly to Discovery-class investigations. This trend will continue in part because the extreme diversity of primitive bodies has only begun to be explored, and also because primitive bodies continue to be discovered at ever-increasing rates providing new opportunities (e.g. the discovery of “main belt” comets or asteroids displaying comet-like outgassing).

During the past decade primitive bodies science has benefited greatly from the Discovery Program. Past and ongoing successes include:

- *NEAR Shoemaker*—The first mission to orbit and land on an asteroid;
- *Stardust*—The first mission to return samples of comet dust to Earth;
- *Deep Impact*—The first mission to investigate the subsurface of a comet and determine the density of a comet nucleus; and
- *Dawn*—A solar-electric propulsion mission on its way to explore two of the largest asteroids in the main belt, 4 Vesta and 1 Ceres.

Primitive body investigations are ideally suited for the Discovery Program. The vast number and diversity of targets provide opportunities to benefit from the frequent launch schedule envisioned by this program. The proximity of some targets allows for important missions that can be carried out at costs below the Discovery cap. Potentially the need to study diverse targets within a population provides opportunities to “refly” proven technology to new targets, thus reducing mission risk and cost.

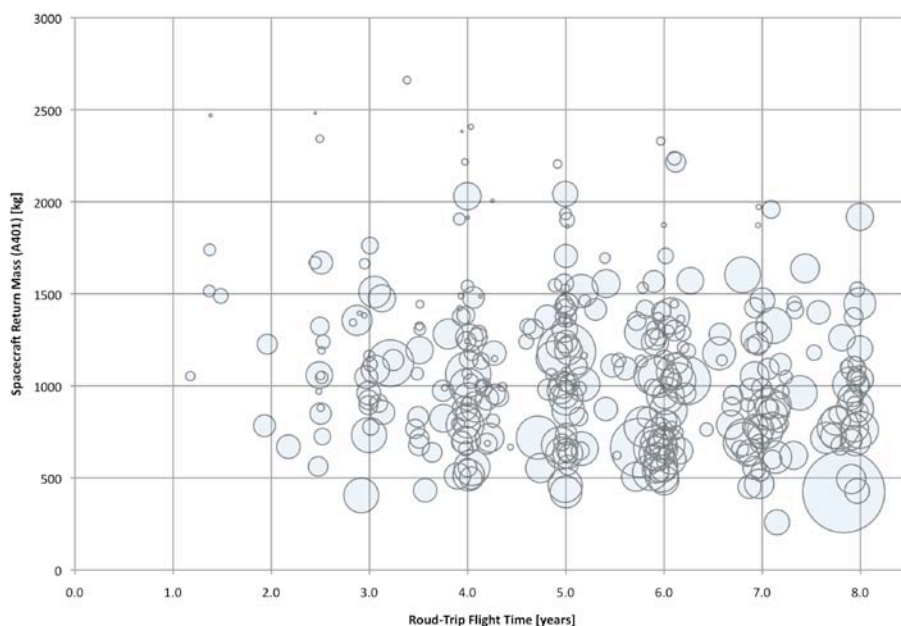

FIGURE 4.1.1 Spacecraft time of flight versus returned mass for sample-return missions to a variety of potential NEO targets. This chart assumes launch on an Atlas V401-class rocket and a spacecraft with chemical propulsion. The size of the “bubble” for each asteroid is based on its estimated diameter. More spacecraft mass is possible with use of solar-electric propulsion (SEP). (A Dawn-like SEP system could increase spacecraft mass by 40-50%.) Each point has been optimized for spacecraft mass and not for flight time. SOURCE: NASA/JPL/Caltech.

There remain many important investigations of primitive bodies that can be carried out within the scope of the Discovery program. Given that the Discovery program is founded on the enterprise and initiative of individuals and is a PI-led endeavor this decadal survey does not attempt to define a set of candidate missions nor priorities, but the committee gives some examples of important Discovery-class investigations that could be carried out in the coming decade. The population of scientifically compelling targets is not static, but is continually increasing as a consequence of discoveries. In no priority order, Discovery missions of significance to primitive bodies may include, but are not limited to, the following:

- *Multiple flybys of asteroids and comets to further investigate the great diversity of these bodies*—Such missions may benefit from using already proven flight systems and instrument technology. A study of NEO target accessibility performed by the Jet Propulsion Laboratory at the committee’s request identified asteroids of at least 5 different taxonomic types, including several not previously visited by spacecraft, that were sufficiently large, had moderate to short mission durations, and low ΔV to be accessible with current resources. A flyby visit of several members of one dynamical family would help provide an understanding of the interior structure and composition of their parent asteroids, and the process of collisional evolution. Telescopic surveys reveal diverse organic compositions in comets, the exploration of which would constrain processes in the protoplanetary disk.

- *Orbital/rendezvous missions to selected comets or asteroids of high scientific interest*—While Dawn’s exploration of 4 Vesta represents a first spacecraft study of a differentiated asteroid, a logical follow-on would be an orbital mission to explore an M-class asteroid with high radar reflectivity that could reasonably be the stripped core of a differentiated asteroid. Differentiation was a fundamental process in shaping many asteroids and all terrestrial planets, and direct exploration of a core could greatly enhance our understanding of this process. Detailed studies of comets that have naturally broken apart provide opportunities to study their pristine interiors.

- *Sample return or geophysical reconnaissance missions to easily accessible NEOs*—Although meteorites provide a rich sampling of NEOs, that sampling is certainly incomplete. As an example, recent spectroscopic studies suggest that some asteroids may be enriched in the earliest solar system solids compared to known meteorites and, thus, may sample an earlier stage of accretion. The microgravity geophysical properties of primitive bodies are not understood. Landed missions to study seismological, radar, or rheological responses of comets and asteroids will answer questions about their formation, accretion and evolution and set the stage for advanced missions such as sample return.

- *Landed investigations of Phobos and Deimos*—A major goal of in situ surface science on the martian moons is to determine their compositions in order to constrain their origins.

- *Stardust-like sample return missions to other Jupiter-family comets to investigate mineralogical/chemical diversity*—The results of multiple missions would provide fundamental insights into the origin of crystalline materials around stars and the processes of radial transport in circumstellar disks.

- *Flyby intercepts of “new” Oort cloud comets to investigate possible chemical differences between these comets and the Jupiter-family comet population*—Such a mission would identify possible chemical and isotopic differences between comets that formed inside Neptune’s orbit and the Jupiter-family comet population that formed beyond the planets.

- *Near-Earth space observatory to study primitive body populations*—Observations from near-Earth space enable the discovery and characterization of primitive body populations that are not observable from ground-based observations, including NEOs having orbits largely existing inside Earth’s orbit, kilometer-sized KBOs, and extremely distant bodies out to the inner parts of the Oort cloud.

During the last half of the past decade the Discovery program was expanded to include missions of opportunity. This program has been highly successful both in providing flight opportunities for U.S.-built instruments on foreign spacecraft and by enabling “re-use” of NASA-built spacecraft that have completed primary missions by retargeting them to new destinations. Additional important primitive

body exploration can be achieved by taking advantage of opportunistic flybys as was done on Galileo (asteroids Gaspra and Ida) and on Rosetta (asteroids Steins and Lutetia).

While many important future missions to primitive bodies can be accomplished with existing technology, the general availability of ASRGs will increase the range of accessible targets and facilitate operations in the close proximity of asteroid and comet surfaces.

REFERENCES

1. D. Brownlee and 181 coauthors. 2006. Comet 81P/Wild2 under a microscope. *Science* 314:1711-1716.
2. L.R. Nittler. 2003. Presolar stardust in meteorites: Recent advances and scientific frontiers. *Earth and Planetary Science Letters* 209:259-273; E. Zinner. 2004. Presolar grains. Pp. 17-39 in *Treatise on Geochemistry, Volume 1: Meteorites, Comets, and Planets* (A.M. Davis, ed.), Elsevier, Oxford.
3. T.J. Bernatowicz, T.K. Croat, and T.L. Daulton. 2006. Origin and evolution of carbonaceous presolar grains in stellar environments. Pp. 109-126 in *Meteorites and the Early Solar System II* (D.S. Lauretta and H.Y. McSween, eds.). University of Arizona Press, Tucson.
4. H.A. Ishii, J.P. Bradley, Z.R. Dai, M. Chi, A.T. Kearsley, M.J. Burchell, N.D. Browning, and F.J. Molster. 2008. Comparison of comet 81P/Wild2 dust with interplanetary dust from comets. *Science* 319:447-450.
5. B. Jacobsen, Q.-Z. Yin, F. Moynier, Y. Amelin, A.N. Krot, K. Nagashima, I.D. Hutcheon, and H. Palme. 2008. ^{26}Al - ^{26}Mg and ^{207}Pb - ^{206}Pb systematics of Allende CAIs: Canonical solar initial $^{26}\text{Al}/^{27}\text{Al}$ ratio reinstated. *Earth and Planetary Science Letters*, 272, 353-364.
6. L.E. Nyquist, Kleine T., C.-Y. Shih, and Y.D. Reese. 2009a. The distribution of short-lived radioisotopes in the early solar system and the chronology of asteroid accretion, differentiation, and secondary mineralization. *Geochimica et Cosmochimica Acta* 73:5115-5136.
7. D. Brownlee and 181 coauthors. 2006. Comet 81P/Wild2 under a microscope. *Science* 314:1711-1716.
8. K.D. McKeegan, A.P. Kallio, V. Heber, G. Jarzebinski, P.H. Mao, C.D. Coath, T. Kunihiro, R.C. Wiens, J.H. Allton, D.S. Burnett. 2009. Oxygen isotopes in a GENESIS concentrator sample (abstract). *Lunar and Planetary Science XL*, CD# 2494.
9. T. Kleine, M. Touboul, B. Bourdon, F. Nimmo, K. Mezger, H. Palme, S.B. Jacobsen, Q.-Z. Yin, and A.N. Halliday. 2009. Hf-W chronology of the accretion and early evolution of asteroids and terrestrial planets. *Geochimica et Cosmochimica Acta* 73:5150-5188.
10. W.F. Bottke, D. Nesvorný, R.E. Grimm, A. Morbidelli, and D.P. O'Brien. 2006. Iron meteorites as remnants of planetesimals formed in the terrestrial planet region. *Nature* 439:821-824.
11. G.M. Bernstein, D.E. Trilling, R.L. Allen, M.E. Brown, M. Holman, and R. Malhotra. 2004. The size distribution of trans-Neptunian bodies. *Astrophysical Journal* 128:1364-1390.
12. A.J. Brearley. 2006. The action of water. Pp. 587-624 in *Meteorites and the Early Solar System II* (D.S. Lauretta and H.Y. McSween, eds.). University of Arizona Press, Tucson.
13. H.Y. McSween, A. Ghosh, R.E. Grimm, L. Wilson, and E.D. Young. 2003. Thermal evolution models of asteroids. Pp. 559-571 in *Asteroids III* (W.F. Bottke, A. Cellino, P. Paolicchi, and R.P. Binzel, eds.). University of Arizona Press, Tucson.
14. C.R. Chapman. 2002. Cratering on asteroids from Galileo and NEAR Shoemaker. Pp. 315-330 in *Asteroids III* (W.F. Bottke, A. Cellino, P. Paolicchi, and R.P. Binzel, eds.). University of Arizona Press, Tucson; P.C. Thomas and 14 coauthors. 2007. The shape, topography, and geology of Tempel 1 from Depp Impact observations. *Icarus* 187:4-15.

15. M. Wadhwa, G. Srinivasan, and R.W. Carlson. 2006. Timescales of planetesimal differentiation in the early solar system. Pp. 715-732 in *Meteorites and the Early Solar System II* (D.S. Lauretta and H.Y. McSween, eds.). University of Arizona Press, Tucson.
16. T. Kleine, M. Touboul, B. Bourdon, F. Nimmo, K. Mezger, H. Palme, S.B. Jacobsen, Q.-Z. Yin, and A.N. Halliday. 2009. Hf-W chronology of the accretion and early evolution of asteroids and terrestrial planets. *Geochimica et Cosmochimica Acta* 73:5150-5188.
17. D.W. Mittlefehldt. 2004. Achondrites. Pp. 291-324 in *Treatise on Geochemistry, Vol. 1. Meteorites, Comets, and Planets* (A.M. Davis, ed.). Elsevier, Oxford.
18. J. Yang, J.F. Goldstein, and E.R.D. Scott. 2007. Iron meteorite evidence for early catastrophic disruption of protoplanets. *Nature* 446:888-891.
19. A. Ghosh, S.J. Weidenschilling, H.Y. McSween, and A. Rubin. 2006. Asteroid heating and thermal stratification of the asteroid belt. Pp. 555-566 in *Meteorites and the Early Solar System II* (D.S. Lauretta and H.Y. McSween, eds.). University of Arizona Press, Tucson.
20. M.C. De Sanctis, M.T. Capria, and A. Coradini. 2001. Thermal evolution and differentiation of Edgeworth-Kuiper Belt objects. *Astron. J.* 121:2792-2799.
21. M.A. Sephton. 2002. Organic compounds in carbonaceous meteorites. *Nat. Product Rpts.* 19:292-311.
22. G. Cody and C.M. Alexander C.M. O'D. 2005. NMR studies of chemical structural variation of insoluble organic matter from different carbonaceous chondrite groups. *Geochimica et Cosmochimica Acta* 69:1085-1097.
23. S. Piazzarello, G.W. Cooper, and G.J. Flynn. 2006. The nature and distribution of the organic material in carbonaceous chondrites and interplanetary dust particles. Pp. 625-651 in *Meteorites and the Early Solar System II* (D.S. Lauretta and H.Y. McSween, eds.). University of Arizona Press, Tucson.
24. G.J. Flynn plus 79 coauthors 2006. Elemental compositions of comet 81P/Wild2 samples collected by Stardust. *Science* 314:1731-1735.
25. S.A. Sandford plus 54 coauthors 2006. Organics captured from comet 81P/Wild2 by the Stardust spacecraft. *Science* 314:1720-1724.
26. B. Marty, R.L. Palma, R.O. Pepin, L. Zimmermann, D.J. Schlutter, P.G. Burnard, A.J. Westphal, C.J. Snead, S. Bajt, R.H. Becker, and J.E. Simones. 2008. Helium and neon abundances and compositions in cometary matter. *Science* 319:75-78.
27. L.M. Feaga, M.F. A'Hearn, J.M. Sunshine, J.M. Groussin, and T.L. Farnham. 2007. Asymmetries in the distribution of H₂O and CO₂ in the inner coma of comet 9P/Tempel 1 as observed by Deep Impact. *Icarus* 190:345-356.
28. K.M. Barkume, M.E. Brown, and E.L. Schaller. 2008. Near-infrared spectra of Centaurs and Kuiper Belt objects. *Astronomical Journal* 135:55-67.
29. V.C. Geers, J.-C. Augereau, K.M. Pontoppidan, C.P. Dullemond, R. Visser, J.E. Kessler-Silacci, N.J. Evans, E.F. van Dishoeck, G.A. Blake, A.C.A. Boogert, J.M. Brown, F. Lahuis, and B. Merín. 2006. C2D Spitzer-IRS spectra of disks around T Tauri stars. II. PAH emission features. *Astronomy and Astrophysics* 459:545-556.
30. D.P. O'Brien, A. Morbidelli, and H.F. Levison. 2006. Terrestrial planet formation with strong dynamical friction. *Icarus* 184:39-58.
31. Q.Z. Yin, S.B. Jacobsen, K. Yamashita, J. Blicher-Toft, P. Telouk, and F. Albarede. 2002. A short timescale for terrestrial planet formation from Hf-W chronometry of meteorites. *Nature* 418:949-952.
32. A.N. Halliday. 2004. The origin and earliest history of the Earth. Pp. 509-557 in *Treatise on Geochemistry, Vol. 1. Meteorites, Comets, and Planets*, Davis A.M., ed.). Elsevier, Oxford.
33. T. Kleine, K. Mezger, C. Münker, H. Palme, and A. Bischoff. 2004. ¹⁸²Hf-¹⁸²W isotope systematics of chondrites, eucrites, and martian meteorites: Chronology of core formation and early mantle differentiation in Vesta and Mars. *Geochimica et Cosmochimica Acta* 68:2935-2946.

34. H.H. Hsieh and D. Jewitt. 2006. A population of comets in the main asteroid belt. *Science* 312:561-563.
35. K. Tsiganis, R. Gomes, Morbidelli, A., and H.F. Levison. 2005. Origin of the orbital architecture of the giant planets of the solar system. *Nature* 435:459-461.
36. R. Gomes, H.F. Levison, K. Tsiganis, and A. Morbidelli. 2005. Origin of the cataclysmic late heavy bombardment period of the terrestrial planets. *Nature* 435:466-469.
37. .G. Strom, R. Malhotra, T. Ito, F. Yoshida, and D.A. Kring. 2005. The origin of planetary impactors in the inner solar system. *Science* 309:1847-1850.
38. J.E. Richardson and P.C. Thomas. 2010. Uncovering the Saturnian impactor population via small satellite cratering records. 41st Lunar and Planetary Science Conference, The Woodlands, Texas. LPI Contribution No. 1533, p.1523.
39. National Research Council. 2010. *New Worlds, New Horizons in Astronomy and Astrophysics*. The National Academies Press, Washington, D.C.
40. National Research Council. 2010. *Defending Planet Earth: Near-Earth-Object Surveys and Hazard Mitigation Strategies*. The National Academies Press, Washington, D.C.
41. National Research Council, *Opening New Frontiers in Space: Choices for the Next New Frontiers Announcement of Opportunity.*, The National Academies Press, Washington, D.C., 2008
42. G. H. Fountain, et al., Comet Surface Sample Study Report. SDO-11998.

5

**The Inner Planets:
The Key to Understanding Earth-Like Worlds**

Earth's inner solar system companions, Mercury, Venus, the Moon, and Mars, are diverse bodies, each of which provides data critical for understanding the formation and evolution of habitable worlds like our own. These terrestrial (or rocky) planetary bodies have a range of compositions and geologic histories—each is a unique world that reveals information crucial for understanding the past, present and future of Earth. This chapter focuses on three particular inner bodies, Mercury, Venus, and the Moon (Figure 5.1). All are essential to understanding how terrestrial planets form and change with time.¹

Current knowledge of these bodies differs, with exploration challenges and major accomplishments (Table 5.1) at each. Within the last decade, initial results from MESSENGER have revealed aspects of the complex early history of Mercury. Venus, with its greenhouse atmosphere, Earth-like size and volcanic surface has been a focus of recent international missions, but remains a challenge for in situ exploration. Recent exploration of the Moon has revealed a geochemically complex surface and polar volatiles (e.g., hydrogen or ice), leading to significant unanswered questions about the Earth-Moon system. The detailed study of Mars² over the last 15 years has greatly increased our understanding of its history, which has in turn allowed us to formulate specific questions to constrain terrestrial planet origin, evolution and habitability.

Thus, the initial reconnaissance of the terrestrial planets is transitioning to more in-depth, in situ study. In this new phase, specific observations can be made to allow testing of hypotheses and significant progress in understanding basic questions that can lead us to an improved understanding of the origin and evolution of all the terrestrial planets, including Earth.

All three of the crosscutting science themes for the exploration of the solar system include the inner planets, and studying the inner planets is vital to answering several of the priority questions in each of them. The Building New Worlds theme includes the question “what governed the accretion, supply of water, chemistry, and internal differentiation of the inner planets and the evolution of their atmospheres, and what roles did bombardment by large projectiles play?” The Planetary Habitats theme includes the question “did Mars or Venus host ancient aqueous environments conducive to early life, and is there evidence that life emerged?” The Workings of the Solar System theme includes two questions that can be answered by the study of the inner planets. First, the lunar impact record holds key information as to “what solar system bodies endanger and what mechanisms shield Earth's biosphere?” Second, studies of Venus and Mars relate directly to “can understanding the roles of physics, chemistry, geology, and dynamics in driving planetary atmospheres and climates lead to a better understanding of climate change on Earth?” Questions as to how the inner planets formed, their composition, and the processes by which they have evolved are a major part of “how have the myriad chemical and physical processes that shaped the solar system operated, interacted, and evolved over time?”

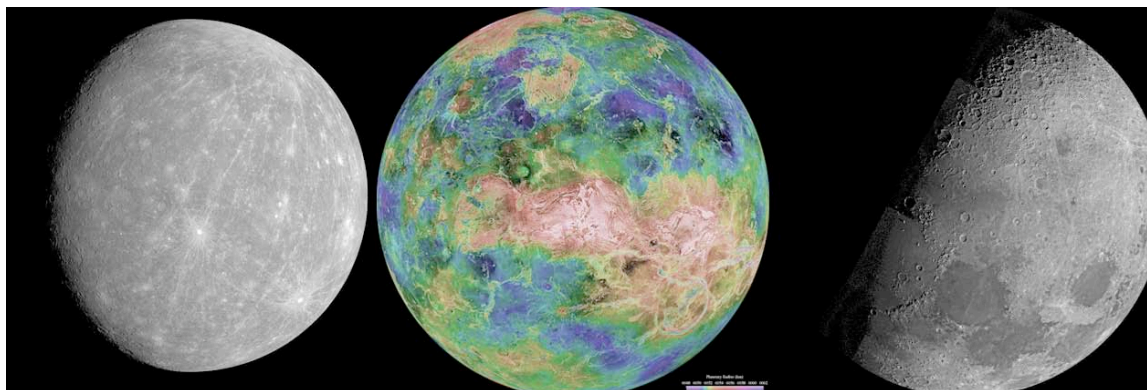

FIGURE 5.1 Mercury, Venus, and the Moon are essential to understanding how terrestrial planets form and change with time. SOURCE: *Mercury*: NASA/JPL; *Venus*: NASA/JPL/USGS; *Moon*: NASA/JPL.

TABLE 5.1 Major Accomplishments of Studies of Mercury, Venus, and the Moon in the Past Decade

Major Accomplishment	Mission and/or Technique
Demonstrated from measurement of Mercury’s forced libration that the planet has a liquid core	Earth-based Radar studies
Found evidence that volcanism has been widespread throughout Mercury’s geological history, with compelling evidence for pyroclastic volcanism, which requires interior volatiles at higher abundances than previously believed	MESSENGER
Identified of zones of locally higher emissivity associated with volcanic centers on Venus, suggestive of geologically recent volcanic activity	Venus Express
Measured lower atmospheric loss rates for hydrogen and higher rates for oxygen, suggesting that Venus may be more hydrated and less oxidized that previously believed	Venus Express
Discovered higher quantities of water on the Moon than previously believed, including interior endogenous water and exogenic water generated by solar wind interactions with silicates and cometary deposits in the extremely cold regions at the lunar poles	Lunar Prospector, Cassini, LRO/LCROSS, Deep Impact, and Chandrayaan 1
Concluded that a potential lunar impact cataclysm also affected all planets in the inner solar system and may have resulted from changes in the orbital dynamics of the gas giants	Theory and modeling of orbital dynamics correlated with the history of impact fluxes throughout the solar system

SCIENCE GOALS FOR THE STUDY OF MERCURY, VENUS, AND THE MOON

The overarching concept that drives the study and exploration of Mercury, Venus, and the Moon is comparative planetology—the idea that learning about the processes and history of one planet (including Earth) is enabled by an understanding of, and comparison to, other planets. Understanding of any individual planet relies on knowledge of the whole solar system, which in turn relies on in-depth exploration of every component of the system: from dust to planets, from Mercury to the outermost comets, from the Sun’s deep interior to the far reaches of the interstellar medium. Comets and asteroids (and meteorites and dust from them) preserve clues to the formation of the solar system and its planets;

PREPUBLICATION COPY—SUBJECT TO FURTHER EDITORIAL CORRECTION

now-quiescent bodies like the Moon and Mercury preserve evidence of the early histories of the terrestrial planets; large, active planets like Venus and Mars show some of the variety of geologic and climatic processes; all help in understanding Earth's past, present, and possible futures. And, as the number of known extrasolar planets continues to grow, the goal of understanding Earth and its life takes on the broader dimension of the search for habitable bodies around other stars.

The goals for research concerning the inner planets for the next decade are threefold:

- Understand the origin and diversity of terrestrial planets. How are Earth and its sister terrestrial planets unique in the solar system and how common are Earth-like planets around other stars? Addressing this goal will require constraining the range of terrestrial planet characteristics, from their compositions to their internal structure to their atmospheres, to refine ideas of planet origin and evolution.
- Understand how the evolution of terrestrial planets enables and limits the origin and evolution of life. What conditions enabled life to evolve and thrive on the early Earth? The Moon and Mercury preserve early solar system history that is a prelude to life. Venus is a planet that was probably much like Earth but is now not habitable. Together, the inner planets frame the question of why Earth is habitable, and what is required of a habitable planet.
- Understand the processes that control climate on Earth-like planets. What determines the climate balance and climate change on Earth-like planets? Earth's climate system is extraordinarily complex, with many inter-related feedback loops. To refine concepts of climate and its change, it is important to study other climate systems, like Venus, Mars and Titan, which permit us to isolate some climate processes and quantify their importance.

Subsequent sections examine each of these goals in turn.

UNDERSTAND THE ORIGIN AND DIVERSITY OF TERRESTRIAL PLANETS

The solar system includes a diversity of rocky planetary bodies, including the terrestrial planets (Mercury, Venus, the Moon, Earth and Mars), the asteroids, and many outer solar systems satellites. Despite their differences, common physical processes guided the formation and evolution of all these bodies. The inner planets are the most accessible natural laboratories for exploring the processes that form and govern the evolution of planets such as Earth.

Understanding the origin and diversity of terrestrial planets encompasses the broad base of research through which scientists compare these terrestrial bodies and learn how they form and evolve. This knowledge is the foundation for understanding how rocky planets work: how they formed early in solar system history; how they acquired their compositions, internal structures, surface and atmospheric dynamics; and what processes have been important throughout their history. Key questions, such as those concerning the development and evolution of life and the intricacies of planetary climate change can only be formulated and addressed by building this base of knowledge.

Fundamental objectives associated with the goal of understanding the origin and diversity of terrestrial planets include the following:

- Constrain the bulk composition of the terrestrial planets to understand their formation from the solar nebula and controls on their subsequent evolution;
- Characterize planetary interiors to understand how they differentiate and dynamically evolve from their initial state; and
- Characterize planetary surfaces to understand how they are modified by geologic processes.

Subsequent sections examine each of these objectives in turn, identify critical questions to be addressed, and suggest future investigations and measurements that could provide answers.

Constrain the Bulk Composition of the Terrestrial Planets to Understand their Formation From the Solar Nebula and Controls on their Subsequent Evolution

Understanding the bulk composition of a planet is key to constraining its origin and subsequent evolution. A planet's bulk composition reflects the interplay and convolution of many processes in the early solar system: transport of dust and gas in the early solar nebula, compositional gradients in the early nebula imposed by time or distance from the Sun, accretion of solids to form self-gravitating bodies, gravitational scattering of those bodies, impacts among those bodies (possibly with chemical fractionation); and redistribution of volatile elements in response to thermal gradients and impact events. After formation, a planet's bulk chemical composition is key to its subsequent evolution; for example, the abundance and distribution of heat-producing elements underlie planetary differentiation, magmatism, and interior dynamical and tectonic processes.

Basic information on surface composition, internal structure, and volatile inventories provides important constraints on the bulk major-element composition of the terrestrial planets. While little progress has been made in the last decade to help determine Venus's bulk composition, major strides have been made in understanding the bulk compositions of Mercury and the Moon. Mercury's high bulk density implies that it is rich in metallic iron. Reflectance spectra from Earth and initial observations from the MESSENGER spacecraft are ambiguous with regards to the composition of Mercury's crust. These spectra suggest that Mercury's surface materials contain little ferrous iron,³ whereas preliminary results by MESSENGER's neutron spectrometer suggest abundant iron or titanium (Figure 5.2).⁴

Substantial research efforts in the last decade using Lunar Prospector and Clementine data, plus new basaltic lunar meteorites, have provided refined estimates of the compositions of the lunar crust and mantle. New observations from Apollo samples have been interpreted as indicating that the bulk volatile content of the Moon is more water-rich than had been thought; if true, this has profound implications for the origin of the Earth-Moon system.

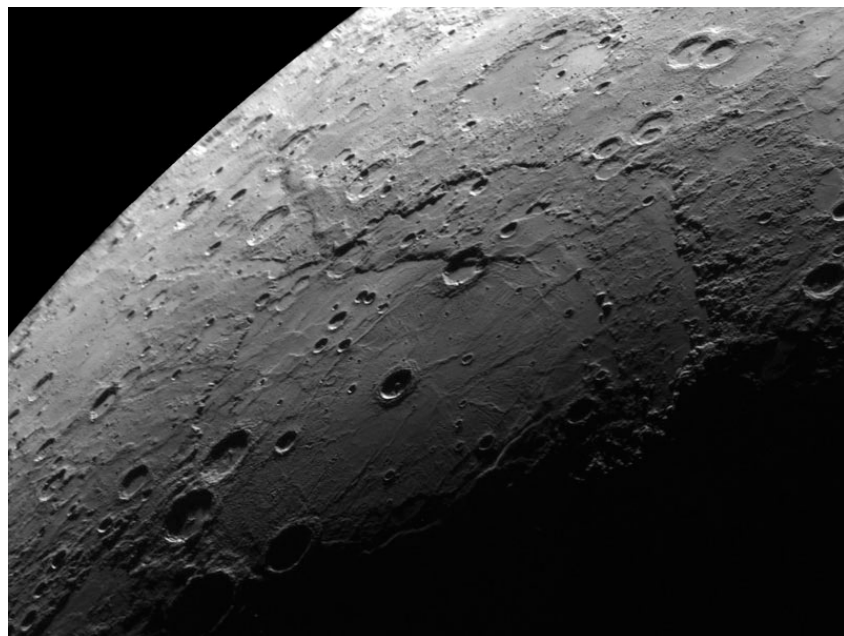

FIGURE 5.2 Rembrandt impact basin on Mercury photographed by MESSENGER. Rembrandt spans over 700 kilometers and at 4 billion years old is possibly the youngest large impact basin on the planet. Geological analysis indicates the basin experienced multiple stages of volcanic infilling and tectonic deformation. SOURCE: Courtesy of NASA/Johns Hopkins University Applied Physics Laboratory/Carnegie Institution of Washington, from the cover of *Science* Vol. 324, no. 5927, May 1, 2009, reprinted with permission from AAAS.

Important Questions

Some important questions for using the bulk composition of the terrestrial planets to understand their formation from the solar nebula and controls on their subsequent evolution include the following:

- What are the proportions and compositions of the major components (e.g., crust, mantle, core, atmosphere/exosphere) of the inner planets?
- What are the volatile budgets in the interiors, surfaces and atmospheres of the inner planets?
- How did nebular and accretionary processes affect the bulk compositions of the inner planets?

Future Directions for Investigations and Measurements

Significant progress in understanding the bulk compositions of the inner planets can be made through in situ and orbital investigations of planetary surfaces, atmospheres and interiors. Future investigations and measurements should include improved understanding of the various types of rock and regolith making up the crusts and mantles of the inner planets, via remote sensing of Mercury's crust, in situ investigation of Venus's crust, and sample return of crust and mantle materials from the Moon. Key geophysical objectives include characterization of the Moon's lower mantle and core, and developing an improved understanding of the origin and character of Mercury's magnetic field. Understanding Venus's bulk composition and interior evolution awaits the critical characterization of noble gas molecular and isotopic composition of the Venus atmosphere. Improved modeling of solar system formation and facilitation of searches for and analyses of extrasolar planetary systems hold great promise for understanding the composition and evolution of the terrestrial planets in general.

Characterize Planetary Interiors to Understand How They Differentiate and Evolve from their Initial State.

Knowledge of the internal structure of the terrestrial planets is key to understanding their histories after accretion. Differentiation is a fundamental planetary process that has occurred in numerous solar system bodies. Important aspects of differentiation include heat loss mechanisms, core formation processes, magnetic-field generation, distribution of heat-producing radioactive elements, styles and extent of volcanism, and the role of giant impacts. Analysis of lunar samples implies the Moon formed hot, with a magma ocean more than 400 km deep. The heat of accretion that led to magma oceans on Earth and the Moon may have been common to all large rocky planets, or may have been stochastically distributed based on the occurrences of giant impact processes. All the large terrestrial planets differentiated into rocky crusts and mantles, and metallic cores, and variously continued to dissipate internal energy via mantle convection, magmatism, magnetic dynamos and faulting, though only Earth appears to have sustained global plate tectonics.

Radar observations of Mercury's rotational state from Earth and improved knowledge of Mercury's gravity field by MESSENGER have led to the detection of a liquid outer core on Mercury advancing our understanding of the internal structure and thermal state.⁵ The dynamic nature of Mercury's interior has been supported by MESSENGER flyby on the internal origin of the planet's magnetic field⁶ and its discovery of extensive volcanic deposits.⁷ Discovery of new lunar rock types from both meteorites and remote sensing data has provided insight into the differentiation of the Moon and the composition and evolution of its crust and mantle. Studies of lunar meteorites as well as improved knowledge of the ages, compositions, and spatial distribution of volcanics have offered new insights into the thermal and magmatic history of the Moon. Although there has been limited progress on understanding the internal structure, evolution, and dynamics of Venus over the last decade, recent results

from Venus Express and Galileo may suggest a dynamic history with potentially evolved igneous rock compositions in some tesserae areas, as well as very young volcanism.⁸

Important Questions

Some important questions concerning characterizing planetary interiors to understand how they differentiate and evolve from their initial state include the following:

- How do the structure and composition of each planetary body vary with respect to location, depth, and time?
- What are the major heat-loss mechanisms and associated dynamics of their cores and mantles?
- How does differentiation occur (initiation and mechanisms) and over what timescales?

Future Directions for Investigations and Measurements

Advancing understanding of the internal evolution of the inner planets can be achieved via research and analysis activities as well as by new mission data at the Moon, Mercury, and Venus. Obtaining higher-resolution topography of Venus would provide new insights into the emplacement mechanisms of features such as mountains and lava flows. Key lunar investigations include determining the locations and mechanisms of seismicity and characterization of the lunar lower mantle and core. New analysis of the ages, isotopic composition, and petrology (including mineralogy) of existing lunar samples, of new samples from known locations, and of remotely sensed rock and regolith types, and continued development of new techniques to glean more information from samples will form the basis of knowledge for the detailed magmatic evolution of the Moon. Experimental petrology, fluid, and mineral physics and numerical modeling of planetary interiors are crucial to understand processes that cannot be directly observed and provide frameworks for future observations.

Characterize Planetary Surfaces to Understand How They Are Modified by Geologic Processes

The distinctive face of each terrestrial planet results from dynamic geologic forces linked to interactions among the crust, lithosphere, and interior (e.g., tectonism and volcanism); between the atmosphere and hydrosphere (e.g., erosion and mass wasting, volatile transport); and with the external environment (e.g., weathering and erosion, impact cratering, solar wind interactions). The stratigraphic record of a planet records these geological processes and their sequence. The geological history of a planet can be reconstructed from an understanding of these geologic processes and the details of each planet's stratigraphic record.

New data from Clementine, Lunar Prospector, LRO, and various international missions (Smart-1, Kaguya, Chang'e-1, Chandrayaan-1) illustrate a diversity of surface features on the Moon, including fault scarps, lava tubes, impact melt pools, polygonal contraction features, and possible outgassing scars. The timing and extent of lunar magmatism has been extended via crater counting and new meteorite samples. Understanding of impact processes has been enhanced by models of crater formation and ejecta distribution, and knowledge of the lunar impact flux has been improved using dynamical modeling and new ages for lunar samples. Although the nature of lunar polar volatile deposits was probed by the LCROSS impactor mission and by instruments aboard LRO and Chandrayaan-1, the form, extent, and origin of such deposits are not fully understood.

Continued analysis of Magellan measurements has revealed extensive tectonism and volcanism on Venus, with great debate over the rates of resurfacing; recent infrared emissivity results from the

VIRTIS spectrometer on the Venus Express spacecraft show that resurfacing processes have continued as recently as 2 million years ago.⁹ MESSENGER's flybys of Mercury have provided views of the regions unseen by Mariner 10 and indicate a more dynamic surface history than previously thought. The diversity of terrains observed by MESSENGER suggests a complex evolution, including extensive tectonism and young volcanism and pyroclastic activity.¹⁰

Important Questions

Some important questions concerning characterizing planetary surfaces to understand how they are modified by dynamic geologic processes include the following:

- What are the major surface features and modification processes on each of the inner planets?
- What were the sources and timing of the early and recent impact flux of the inner solar system?
- What are the distribution and timescale of volcanism on the inner planets?
- What are the compositions, distributions, and sources of planetary polar deposits?

Future Directions for Investigations and Measurements

Major advances in our understanding of the geologic history of the inner planets will be achieved in the coming decade through orbital remote sensing of Venus, the Moon and Mercury, as well as in situ data from Venus and the Moon. Key among these are global characterization of planetary morphology, stratigraphy, composition, and topography, modeling the time variability and sources of impacts on the inner planets and continued analysis of sample geochronology to help provide constraints on the models. Also crucial is developing an inventory and isotopic composition of lunar polar volatile deposits to understand their emplacement and origin, modeling conditions and processes occurring in permanently shadowed areas of the Moon and Mercury and continued observation of Mercury's volatile deposits to understand their origin.

UNDERSTAND HOW THE EVOLUTION OF TERRESTRIAL PLANETS ENABLES AND LIMITS THE ORIGIN AND EVOLUTION OF LIFE

Is Earth the only planet that has (or had) life? Understanding how the evolution of the terrestrial planets enables and limits the origin and evolution of life is closely aligned with other NASA efforts, including astrobiology and Mars exploration. This goal is also relevant to the study of Mars, moons like Europa, Enceladus, and Titan, and terrestrial planets orbiting stars other than the Sun.

The existence of life, present or past, depends on planetary context and the availability of energy, nutrients, and clement environments. Thus, it is crucial to explore the inner solar system in great detail in order to understand the constraints on and possible timing of habitable conditions. The Moon and Mercury are unlikely to harbor life, but they provide critical records of processes and information about the early solar system when life emerged on Earth. Earth is the single known planet that provided all the necessities for the origin and persistence of life, but Venus may have once supported oceans of liquid water and so, possibly, life. Similarly, Mars's surface shows signs of abundant water in its distant past, and may likewise have supported life. Finally, learning about the circumstances that limit or promote the origin and evolution of life will inform current understanding of extrasolar planets and the search for life in the universe.

Fundamental objectives that will help understand how the evolution of terrestrial planets enables and limits the origin and evolution of life are as follows:

PREPUBLICATION COPY—SUBJECT TO FURTHER EDITORIAL CORRECTION

- Understand the composition and distribution of volatile chemical compounds;
- Understand the effects of internal planetary processes on life and habitability; and
- Understand the effects of processes external to a planet on life and habitability.

Subsequent sections examine each of these objectives in turn, identify critical questions to be addressed and future investigations and measurements that could provide answers.

Understand the Composition and Distribution of Volatile Chemical Compounds

To address objectives relating to the composition and distribution of volatile chemical compounds it is crucial to improve understanding of the sources, sinks, and physical states of water and of chemical compounds containing hydrogen, carbon, oxygen, sulfur, phosphorus, and nitrogen on and in the inner planets (including Mars), as functions of time and position in our solar system. These compounds are the basis of life as we know it, as well as the prebiotic chemistry that can form under a limited known range of physical conditions (e.g., pressure, temperature, electromagnetic fields, and radiation environments).

Understanding the distribution of volatiles in the inner solar system has advanced significantly in the past decade, due in large part to ongoing NASA spacecraft missions and research programs. Remote sensing of the Moon has shown that broad areas near the poles contain significant hydrogen; recent radar data suggest some of this hydrogen is present as water ice. The LCROSS impact experiment detected abundant volatiles at one shadowed polar region. Results from the Moon Mineralogy Mapper (M3) spectrometer on India's Chandrayaan-1 spacecraft have detected widespread water (or hydroxyl) in regolith at higher latitudes. In addition, sample analyses show that some beads of lunar volcanic glass and minerals from mare basalts contain concentrations of hydrogen high enough to suggest that their parent magma contained as much water as Earth's mantle. These results are new and their interpretation is still in flux, but they may overturn the conventional wisdom that the Moon is "dry."

For Mercury, Earth-based radars have located deposits in polar craters that are probably water ice. Among the MESSENGER spacecraft's discoveries so far are young volcanic pyroclastic deposits, which suggest sufficient internal volatiles to nucleate and grow bubbles in ascending magmas. More evidence on the presence and perhaps distribution of hydrogen on the surface of Mercury can be anticipated from the spacecraft's neutron spectrometer (which will map the abundance of H in the regolith) and its VNIR spectrometer (which may detect some hydrous minerals if present). Understanding the volatile budget and history of Venus has also advanced, mostly through improved knowledge of its current atmosphere. Venus Express-VIRTIS and Galileo NIMS infrared images of Venus's surface suggest that tesserae may be composed of felsic rock (e.g., perhaps comparable to granites on Earth), a finding that would be consistent with the production of hydrous (and perhaps Na- and/or K-rich) magmas in Venus's early history.

Important Questions

Some important questions relating to the composition and distribution of volatile chemical compounds include the following:

- How are volatile elements and compounds distributed, transported, and sequestered in near-surface environments on the surfaces of the Moon and Mercury? What fractions of volatiles were outgassed from those planets' interiors, and what fractions represent late meteoritic and cometary infall?
- What are the chemical and isotopic compositions of hydrogen-rich (possibly water ice) near the Moon's surface?

- What are the inventories and distributions of volatile elements and compounds (species abundances and isotopic compositions) in the mantles and crusts of the inner planets?
- What are the elemental and isotopic compositions of species in Venus's atmosphere, especially the noble gases and nitrogen-, hydrogen-, carbon- and sulfur-bearing species? What was Venus's original volatile inventory and how has this inventory been modified during Venus's evolution? How and to what degree are volatiles exchanged between Venus's atmosphere and its solid surface?
- Are Venus's highlands and tesserae made of materials suggestive of abundant magmatic water (and possibly liquid water on the surface)?

Future Directions for Investigations and Measurements

Key to constraining the character of volatile chemical compounds on Venus, the Moon and Mercury are determining (1) the state, extent, and chemical and isotopic compositions of surface volatiles particularly in the polar regions on the Moon and Mercury; (2) the inventories and isotopic compositions of volatiles in the mantles and crust of all the terrestrial planets; and (3) the fluxes of volatiles to the terrestrial planets (e.g., by impact) over time. Of high importance for Venus is to obtain high-precision analyses of the light stable isotopes (especially carbon, hydrogen, oxygen, nitrogen, and sulfur) in the lower atmosphere and noble gas concentrations and isotopic ratios throughout its atmosphere. Also key is the continued evaluation of the effects of meteoroid impact fluxes and intensities on the development and evolution of life on the inner planets through analysis of the impact record on the Moon and Mercury.

Understand the Effects of Internal Planetary Processes on Life and Habitability

It is crucial to understand how planetary environments can enable or inhibit the development and sustainment of prebiotic chemistry and life. This objective focuses on the availability of accessible energy and nutrients (chemicals and compounds), and the establishment and maintenance of clement stable environments in which life could have arisen and flourished. Also important are the initiation and termination of planetary magnetic fields, which can enable shielding of a planet's surface from external radiation.

Despite the dearth of spacecraft missions to explore the inner planets in the past decade, there have been several important discoveries about internal processes. Recent flybys of Mercury by MESSENGER have confirmed the dipole field measured by Mariner 10. Flyby data also confirm that Mercury's plains are volcanic, and show that some are far younger than previously proposed. Further improvements in our knowledge of Mercury's internal structure and geologic history are expected after MESSENGER enters its mapping orbit in 2011.

Constraints on Venus's current tectonic style and extensive volcanism are based mostly on radar imagery and altimetry from the Magellan mission. Recent results from the VIRTIS spectrometer on the Venus Express spacecraft provide evidence that Venus's tesserae are more felsic than mafic, and that Venus's volcanoes have been active in the geologically recent past (consistent with models of gradual rather than catastrophic resurfacing). For the Moon, although much of what was learned about its interior in the Apollo era remains intact, new evidence of volatiles in lunar magmas is altering that view.

Important Questions

Some important questions concerning the effects of internal planetary processes on life and habitability include the following:

- What are the timescales of volcanism and tectonism on the inner planets?

- Is there evidence of environments that once were habitable on Venus?
- How are planetary magnetic fields initiated and maintained?

Future Directions for Investigations and Measurements

Progress can be made in understanding how internal processes affect planetary habitability through focused measurements and research that “follow the volatiles” from the interiors, to the surfaces, to escape from the atmospheres of the inner planets. Future investigations should include determining the transport rates and fluxes of volatile compounds between the interiors and atmospheres of the inner planets, specifically Venus; determining the composition of the Venus highlands; constraining the styles, timescales and rates of volcanism and tectonism on Venus, the Moon and Mercury through orbital and in situ investigations; and measuring and modeling the characteristics and timescales of planetary magnetic fields and their influence on planetary volatile losses and radiation environments.

Understand How Processes External to a Planet can Enable or Thwart Life and Prebiotic Chemistry

External processes can be crucial enablers or inhibitors of the origin and evolution of life. Understanding of these external processes overlaps partially with the objective of understanding the composition and distribution of volatile chemical compounds. In other words, volatiles can be brought to a planet or leave via external processes (e.g., comet impacts delivering volatiles, or solar wind removing them). The origin and evolution of life can be influenced by other external processes such as stellar evolution, atmospheric losses to space, effects of impacts, orbital interactions of planetary bodies, cosmic ray fluxes, supernovae, and interstellar dust clouds.

The last decade has seen progress in many aspects of external influences on planets. There has been significant progress in understanding impact processes and delivery of volatiles, and in finding potential mechanisms for impact “swarms” like the putative late heavy bombardment (e.g., the “Nice model” of orbital evolution in the outer solar system).¹¹ Additionally, sample returns from comets and of the solar wind, and continued analyses of meteorite samples have increased our understanding of the distribution and compositions of volatiles in the solar system. Astronomical observations of star-forming regions and of supernovae provide important constraints on the origins of solar systems (and potential early processes), the effects of supernovae, and the nature and potential effects of interstellar dust clouds.

Important Questions

Some important questions concerning how processes external to a planet can enable or thwart life and prebiotic chemistry include the following:

- What are the mechanisms by which volatile species are lost from terrestrial planets, with and without substantial atmospheres (i.e., Venus versus the Moon), and with and without significant magnetic fields (i.e., Mercury versus the Moon)? Do other loss mechanisms or physics become important in periods of high solar activity?
 - What are the proportions of impactors of different chemical compositions (including volatile contents) as functions of time and place in the solar system?
 - What causes changes in the flux and intensities of meteoroid impacts onto terrestrial planets, and how do these changes affect the origin and evolution of life? What are the environmental effects of large impacts onto terrestrial planets?

Future Directions for Investigations and Measurements

Fundamental models of volatile delivery and loss relevant for understanding how processes external to a planet can enable or thwart life and prebiotic chemistry can be constrained by investigation of loss rates of volatiles from planets to interplanetary space, in terms of solar intensity, gravity, magnetic field environment, and atmospheric composition. Also key are to characterize volatile reservoirs that feed volatiles onto terrestrial planets after the main phases of planetary accretion (e.g., a late chondritic veneer, heavy bombardment) and to evaluate impact intensity and meteoritic and cometary fluxes to the terrestrial planets through time, including calibration of the lunar impact record.

UNDERSTAND THE PROCESSES THAT CONTROL CLIMATE IN ORDER TO CONSTRAIN BOTH LONG-TERM CLIMATE EVOLUTION ON TERRESTRIAL PLANETS AND SHORT-TERM NATURAL AND ANTHROPOGENIC FORCINGS ON EARTH

Terrestrial life and human civilizations have been profoundly affected by climate and climate change. To understand and predict climate variations, one must understand many aspects of planetary evolution on different timescales. Critical issues include the variation of terrestrial climate over geologic timescales, the causes of extreme climate excursions (e.g., snowball Earths and the Paleocene/Eocene Thermal Maximum approximately 55 million years ago), understanding the stability of our current climate, and clarifying the effects of anthropogenic perturbations. This goal is closely aligned with other NASA efforts, especially in Earth science. A key tenet is that detailed exploration and intercomparisons of the inner planets contribute significantly to understanding the factors that affect Earth's climate—past, present, and future.

Fundamental objectives on the path to understand the processes that control climate in order to constrain both long term climate evolution on terrestrial planets and short term natural and anthropogenic forcings on Earth include the following:

- Determine how solar energy drives atmospheric circulation, cloud formation and chemical cycles that define the current climate on terrestrial planets;
- Characterize the record of and mechanisms for climate evolution on Venus, with the goal of understanding climate change on terrestrial planets, including anthropogenic forcings on Earth;
- Constrain ancient climates on Venus, and search for clues into early terrestrial planet environments so as to understand the initial conditions and long-term fate of Earth's climate.

Subsequent sections examine each of these objectives in turn, identify critical questions to be addressed and future investigations and measurements that could provide answers.

Determine How Solar Energy Drives Atmospheric Circulation, Cloud Formation and Chemical Cycles that Define the Modern Climate Balance on Terrestrial Planets

Results from Venus Express show that Venus's atmosphere is highly dynamic with abundant lightning, unexpected atmospheric waves, and aurora and nightglows that respond to high altitude global winds. Venus Express has also found evidence of relatively recent volcanism, in a geographical correlation of low near-infrared emissivity with geological hot-spot volcanoes.¹² These observations support the model that Venus's current climate is maintained, at least in part, by volcanic emission of sulfur dioxide that feeds the global clouds of sulfuric acid. These inferences confirm that some climate processes on Venus are similar to those on Earth, and that a better understanding of Venus's climate system will improve our understanding of Earth's, and provide real-world tests of computer codes—general circulation models (GCMs)—that attempt to replicate climate systems.

PREPUBLICATION COPY—SUBJECT TO FURTHER EDITORIAL CORRECTION

Important Questions

Some important questions concerning how solar energy drives atmospheric circulation, cloud formation and chemical cycles that define the modern climate balance on terrestrial planets include the following:

- What are the influences of clouds on radiative balances of planetary atmospheres, including cloud properties: microphysics, morphology, dynamics and coverage?
- How does the current rate of volcanic outgassing affect climate?
- How do the global atmospheric circulation patterns of Venus differ from those of Earth and Mars?
- What are the key processes, reactions and chemical cycles controlling the chemistry of the middle, upper and lower atmosphere of Venus?
- How does the atmosphere of Venus respond to solar-cycle variations?

Future Directions for Investigations and Measurements

Processes controlling the current climates of the terrestrial planets must be characterized to interpret and reconstruct their climate histories. These data will be incorporated into a new generation of planetary GCMs that will increase the ability of terrestrial GCMs to predict climate and thereby improve understanding of anthropogenic effects. Investigations for the coming decade should include measurement of the influence of clouds on radiative balances at Venus with both in situ and orbital investigations including cloud microphysics, morphology, dynamics and coverage, and elucidation of the role of volcano-climate interactions. It will be important to better explain Venus's global circulation within the theoretical framework of modeling techniques developed for terrestrial GCMs and to understand the chemistry and dynamics of Venus's middle atmosphere. This includes characterizing the photochemistry of chlorine, oxygen, and sulfur on Venus and measuring current atmospheric escape processes at Venus with orbital and in situ investigations. To better understand Earth's climate we must carefully compare the solar cycle responses of the upper atmospheres, exospheric escape fluxes and climates.

Characterize the Record of and Mechanisms for Climatic Evolution on Venus with the Goal of Understanding Climate Change on Terrestrial Planets, Including Anthropogenic Forcings on Earth

Progress has been made over the last decade in understanding the changes and evolution of terrestrial planet climates. The Venus Express mission¹³ and results from the Galileo fly-by of Venus¹⁴ have provided tantalizing evidence that Venus's highlands may be more evolved (i.e., more silicic) than the volcanic plains. These results could signify that at some time in the past, evolved, hydrous magmas were erupted on Venus, and that the highland material may represent remnant continental crust.

Recent results for the other inner planets have placed better constraints on rates and mechanisms of volatile loss (e.g., MESSENGER spacecraft data on Mercury's exosphere and Venus Express SPICAV results for Venus hydrogen and oxygen loss). MESSENGER observations of Mercury's surface suggest that pyroclastic deposits may be as young as 1 billion years, and that Mercury's interior contained sufficient volatiles to drive those eruptions. For the Moon, a pyroclastic origin has also been postulated for some deposits,¹⁵ with similar implications for volatile content and release.¹⁶ And, there is a tantalizing hint that a few areas of the Moon have recently released gases.¹⁷

Important Questions

Current concerns about the near-term future and fate of Earth's climate drive the need to understand better what triggered and sustains Venus's runaway greenhouse atmosphere and how the atmospheres of terrestrial planets co-evolve with geological and biological processes. Key questions that can be addressed in the coming decade are:

- What is the history of the runaway greenhouse on Venus and is this a possible future for Earth's climate?
- What is the relative role of water on the terrestrial planets in determining climate, surface geology, chemistry, tectonics, interior dynamics, structure, and habitability?
- What is the history of volcanism and its relationship to interior composition, structure and evolution (e.g., outgassing history and composition, volcanic aerosols and climate forcing)?
- How has the impact history of the inner solar system influenced the climates of the terrestrial planets?
- What are the critical processes involved in atmospheric escape of volatiles from the inner planets?

Future Directions for Investigations and Measurements

Comparative studies of climate change on the inner planets can provide context and deeper understanding of the history of Earth's climate. They will also allow us to better understand the dynamics of complex nonlinear climate systems, and better estimate the strengths of climate forcings and the sensitivity of the climate system to various feedback mechanisms. Important aspects to study include quantifying (1) surface/atmosphere interactions on Venus, including the composition of the lower atmosphere, the bulk composition and mineralogy of Venus's surface rocks, and effects of that interaction at depth in Venus's crust and (2) the effects of outgassing (volcanic and other) fluxes (e.g., biogenic methane) on the climate balances of terrestrial planets, with emphasis on Venus. Studying complex nonlinear global systems theory through analysis of Venus climate feedback is a priority, along with validation of the techniques and models used for terrestrial climate predictions by determining their ability to understand non-terrestrial climates.

Other important aspects are to improve understanding of the role of life in terrestrial planet climate evolution and the likely divergent paths of inhabited and lifeless planets, and to better characterize the impact bombardment history of the inner solar system as it has affected the habitability of Earth, Mars, and Venus through time. Keys to advancing our knowledge are to measure the stable isotopes of the light elements (e.g., carbon, hydrogen, oxygen, nitrogen, and sulfur) on Venus for comparison with terrestrial and martian values and to identify mechanisms of gas escape from terrestrial planet atmospheres, and quantify their rates as functions of time, magnetic field strength, distance from the Sun, and solar activity.

Constrain Primordial Climates on Venus and Search for Clues into Earth's Early Environment so as To Understand the Initial Conditions and Long-term Fate of Earth's Climate

Planetary exploration provides unique opportunities to study the most ancient or primordial climates of the terrestrial planets. By establishing the early climate conditions on Venus and Mars, finding clues on the Moon to the earliest terrestrial environment, and characterizing the primordial impact environment throughout the inner solar system, the initial conditions that led eventually to the current climate systems of Earth and the other terrestrial planets can be determined. These efforts will permit an understanding of how climates on Earth-like planets respond to evolving solar radiation on cosmic

timescales, including the possible analogies between a possible ancient climate catastrophe on Venus and the long term future of Earth's climate system.

Many advances in the last decade for ancient climates have been about Venus, based mostly on results from the Venus Express spacecraft. Venus Express has found new clues to the mystery of Venus's seemingly tortured climatic past by measuring flows of escaping atoms and ions and finding a surprising altitude-dependence of the deuterium to hydrogen ratio at certain latitudes. Venus's atmosphere has a large deuterium/hydrogen ratio compared to Earth and other solar system bodies, and this ratio has been taken to indicate significant loss of hydrogen (with mass fractionation) from its atmosphere to space. However, the SPICAV instrument of Venus Express has found that the deuterium/hydrogen ratio is significantly higher at and above the cloud deck than nearer to the surface. This enrichment could be caused by some photochemical process (molecular decomposition or planetary escape) or selective condensation into clouds.¹⁸

Data from the ASPERA instrument on Venus Express suggest provisionally that hydrogen escape rates are an order of magnitude slower than previously assumed, implying that the hydrogen in Venus's atmosphere has an average residence time of some 1 billion years.¹⁹ This result, if confirmed by further observations during an extended Venus Express mission, has important implications for the history of water and the current rate of outgassing on Venus. Another significant discovery is that Venus's atmosphere is losing unexpectedly large quantities of oxygen to deep space, via non-thermal processes. This finding calls into question the long-standing assumption that massive escape of hydrogen from Venus's atmosphere must have left the atmosphere and surface highly oxidized.

Important Questions

Some important questions concerning the primordial climates on Venus and Mars and the search for clues into Earth's early environment include the following:

- Do volatiles on Mercury and the Moon constrain ancient atmospheric origins, sources and loss processes?
- How similar or diverse were the original states of the atmospheres and the coupled evolution of interiors and atmospheres on Venus, Earth, and Mars?
- How did early extreme ultraviolet flux and solar wind influence atmospheric escape in the early solar system?

Future Directions for Investigations and Measurements

To make significant progress towards the goal of understanding the processes controlling climate on the terrestrial planets requires observations over a significant fraction of a solar cycle in order to derive a time averaged escape flux for recent epochs and to understand the relative importance of several escape mechanisms. Several critical areas of investigation are as follows (1) measure and model the abundances and isotopic ratios of noble gases on Venus to understand how similar its original state was to those of Earth and Mars, and to understand the similarities and differences between the coupled evolution of interiors and atmospheres for these planets; (2) characterize ancient climates on the terrestrial planets, including searching for isotopic or mineral evidence of ancient climates on Venus; and (3) examine the geology and mineralogy of the tesserae on Venus to search for clues to ancient environments.

INTERCONNECTIONS

Links to Other Solar System Bodies

The processes that occur in the atmospheres, surfaces and interiors of the inner planets are governed by the same principles of physics and chemistry as those found on other solar system bodies. Comparing and contrasting the styles of past and present interior dynamic, volcanic, tectonic, aeolian, mass wasting, impact, and atmospheric processes can provide significant insight into such processes. The information gleaned from any single body, even Earth, is only one piece in the puzzle of understanding the history and evolution of the solar system and the bodies within it.

Impacts are ubiquitous across the solar system, and provide an important chronometer for the dating of surface regions on objects throughout the solar system. Unraveling solar system impact history has relied heavily on the lunar impact record. Both the Moon and Ganymede retain an impact signature that suggests a late heavy bombardment due to migration of the gas giants. The impactors themselves, derived mostly from asteroids and comets, provide important clues to evolution of the early solar system and the building blocks of the planets and their satellites.

Tectonic and volcanic styles vary significantly across the solar system. Comparison of active volcanic styles on Venus, Earth, Io, and several of the icy satellites in the outer solar system, and tectonic and volcanic styles on all solid planetary bodies provides information on the mechanisms by which planetary bodies dissipate primordial, tidal and radiogenic heat. In particular, the conditions that lead to planets like Earth with plate tectonics, single-plate bodies like Mercury and the Moon, and the spectrum of bodies with intermediate behavior can be characterized.

Further characterization of current or paleo-dynamos in the cores of the terrestrial planets and satellites of the outer solar system may significantly increase our knowledge of magnetic field generation and evolution in planetary cores.

Planetary exospheres, those tenuous atmospheres that exist on many planetary bodies, including the Moon, Mercury, asteroids, and some of the satellites of the giant planets, are poorly understood at present. Insight into how they form, evolve, and interact with the space environment would greatly benefit from comparisons of such structures on a diversity of bodies.

Understanding of atmospheric and climatic processes on Venus, Mars, and Titan may provide hints to the early evolution of the atmosphere on Earth, and clues to future climate. Similarly, increased understanding of potential past liquid water environments on Venus and Mars may result in greater insight into the evolution of habitable environments and early development of life.

There may be significant advantages in taking a multi-planet approach to instrument and mission definition and operation. Major cost and risk reductions for future missions can result from a synergistic approach to developing technologies for scientific exploration of planetary bodies. For example, technologies, including sample collection, cryogenic containment and transport, and tele-operation may have application for sample return missions across the solar system. Balloon technologies for Venus may find application at Titan.

Links to Astrobiology

The spatial extent and evolution of habitable zones within the early solar system are critical elements in the development and sustainment of life, and in addressing questions of whether life developed on Earth alone or was developed in other solar system environments and imported here. Studies of the origin and evolution of volatiles on the terrestrial planets, including loss of water from Venus and Mars, and the effects of early planetary magnetic fields and variation in the solar wind over time are critical to our understanding of where environments might have existed for the development of life. While recent orbital and rover missions on Mars have identified early environments on that planet

that may have fostered life, there is no evidence from the low-resolution images from past missions of the existence of early terrains on Venus. Surface mapping of Venus at higher resolution is needed.

An understanding of the impact flux in the early solar system as a function of time, including verification of the reality or otherwise of the late heavy bombardment, provides critical information on potential limits to the early development of life on Earth and other bodies. Age measurements on returned samples from a broader range of impact basins on the Moon would enable greater quantification of the impact history of the inner solar system.

Links to Extrasolar Planets

Ground- and space-based searches for extrasolar planets have expanded significantly over the last decade, resulting in an explosion of new discoveries. A significant reduction in the threshold planetary size for detection has been achieved. Moreover, the atmospheric compositions of a small number of these planets have been probed. In a number of cases, the sizes and orbits of extrasolar planets have run counter to prior models of the formation and dynamics of planetary systems. Studies of the structural and dynamical evolution of the solar system can significantly enable studies of extrasolar planets. For example, models for migration of the gas giants in the solar system, which could have caused the late heavy bombardment some 3.9 billion years ago, provide new perspectives on evolution in planetary systems.

In addition, characterization of planetary atmospheres within the solar system will facilitate greater understanding of atmospheric structure and chemistry in distant planetary systems, as well as providing potential signatures for habitable zones. Knowledge of the geophysical and geochemical structures of the terrestrial planets can be scaled to model the larger sizes of extrasolar super-Earths. In particular, the effects of planetary size on such processes as core dynamo formation, internal and surface dynamics, heat loss processes, and the development of atmospheres can be investigated.

Links to Human Exploration

The Moon is a logical step in the process of continued human exploration of the solar system, and it is conceivable that human precursor missions and human missions might return to the lunar surface in the coming decades. While human precursor missions are not necessarily science driven, science will definitely be a beneficiary of any precursor activity. Lunar scientists can provide critical scientific input to the design and implementation of any human precursor activity to ensure that the science return is maximized within the scope of the mission. Should human missions occur, the presence of geologically trained astronauts on the lunar surface could enable significant scientific in situ activities and make informed down-selections onsite to ensure the return of material with the highest scientific value.

SUPPORTING RESEARCH AND RELATED ACTIVITIES

Research and Analysis

For stability and scientific productivity, NASA research and analysis (R&A) need long-term core programs that sustain the science community and train the next generations of scientists. For flexibility, these core programs are complemented by R&A programs that target strategic needs (e.g., planetary cartography, comparative planetary climatology, and planetary major equipment) and shorter-term specific needs (e.g., data analysis programs, and participating scientist programs). R&A programs like planetary cartography are also critical for mission planning by ensuring that (for instance) cartographic and geodetic reference systems are consistent across missions to enable proper analysis of returned data.

PREPUBLICATION COPY—SUBJECT TO FURTHER EDITORIAL CORRECTION

To complement existing R&A programs, the committee recognizes a current need for a new focus on comparative climatology. There is a pressing need for more data and better models of climate evolution, prompted in part by the recognition of possible anthropogenic effects on Earth's climate and the need to understand the robustness of current climate trends, and determination whether apparent cause-effect relationships are accurate. Climate research cuts across the standard disciplines. Climate and its change on a single planet cannot be understood without in-depth knowledge of geology, hydrology, and meteorology. And each terrestrial planet (and satellite) with a "thick" atmosphere provides a different mix of processes and forcings that can inform and constrain models for the other planets. NASA's R&A programs support portions of this research (e.g., Titan hydrology in Outer Planets Research, Mars meteorology in Mars Fundamental Research), but lacks a program where cross-disciplinary, multi-planet climate research can be realized and funded.

TECHNOLOGY DEVELOPMENT

Although the inner solar system is Earth's immediate neighborhood, the exploration of Mercury, Venus, and the Moon presents unique challenges that require strategic investments in new technology and new spacecraft capabilities. While orbital missions to all of these bodies have been conducted or are underway now, in situ exploration requires that spacecraft can survive harsh chemical and physical environments. The lack of an atmosphere at Mercury and the Moon, for example, coupled with their relatively large masses, means that landed missions incur either a substantial propulsion burden for soft landing or large landing shocks at impact. The development of a robust airless body lander system incorporating high-impulse chemical propulsion, impact attenuation, and low-mass subsystems will enable extensive surface exploration in the coming decades.

Venus and Mercury, and to a lesser extent the Moon, also represent extreme thermal environments that will stress spacecraft capabilities. High-temperature survivability technologies such as new materials, batteries, electronics, and possibly cooled chambers will enable long-term in situ missions.

The development of robust scientific instruments and sampling systems, including age-dating systems, spectrometers, seismometers, and sub-surface drilling and related technologies is also critical in addressing the scientific objectives for the coming decades. New capabilities for in situ age dating are of particular importance, as they can help to provide constraints on models of surface and interior evolution of all the terrestrial planets.

ADVANCING STUDIES OF THE INNER PLANETS: 2013-2022

Previously Recommended Missions

A series of NRC reports, culminating in the 2003 planetary science decadal survey²⁰ affirm that the exploration of Mercury is central to the scientific understanding of the solar system. The successful achievement of scientific objectives of the NASA's MESSENGER and ESA/JAXA's BepiColombo missions remain a high priority. Given all the advances that will likely come from MESSENGER and BepiColombo, as well as ongoing technology and capability enhancement work, the high-priority of Mercury landed science could be revisited at the earliest opportunity mid to late in this decade.

Previously Recommended New Frontiers Missions

The 2003 planetary decadal survey included recommendations for New Frontiers missions to Venus and the Moon.²¹ They are:

- Venus In Situ Explorer
- South Pole-Aitken Basin Sample Return

Venus In Situ Explorer

WISE's importance was reaffirmed in the NRC's *Opening New Frontiers in Solar System Exploration*.²² The rationale for VISE is that many crucial analyses of Venus cannot be obtained from orbit and instead require in situ investigations. Sample return appears beyond current technology, and Venus's thick atmosphere limits the primary tools for surface investigations from orbit to radar, radio science, gravity, and a few windows in near-infrared wavelengths. The science mission objectives for VISE from these previous reports are as follows:

- Understand the physics and chemistry of Venus's atmosphere, especially the abundances of its trace gases, sulfur, light stable isotopes, and noble gas isotopes;
- Constrain the coupling of thermochemical, photochemical, and dynamical processes in Venus's atmosphere and between the surface and atmosphere to understand radiative balance, climate, dynamics, and chemical cycles;
- Understand the physics and chemistry of Venus's crust;
- Understand the properties of Venus's atmosphere down to the surface and improve our understanding of Venus's zonal cloud-level winds;
- Understand the weathering environment of the crust of Venus in the context of the dynamics of the atmosphere and the composition and texture of its surface materials; and
- Look for planetary scale evidence of past hydrological cycles, oceans, and life and for constraints on the evolution of the atmosphere of Venus.

Achieving all of these objectives represents a flagship-class investment,²³ but achieving a majority is considered feasible in the New Frontiers Program.²⁴

In the 2003 decadal survey, the long-term goal was extraction and return to Earth of samples (solid and gas) from the Venus surface, clearly a flagship-class mission, and VISE was considered in terms of its contribution to this sample return. The 2008 NRC report suggested that VISE not be tied to Venus sample return, given the huge (and so-far unanswered) technical challenges posed by the latter. VISE-like missions do, however, provide the rare opportunities for technical demonstrations in the Venus near-surface environment, and inclusion of demonstration technologies on a VISE mission would be justified (on a non-interference, non-critical-path basis).

South Pole–Aiken Basin Sample Return

The exploration and sample return from the Moon's South Pole-Aitken (SPA) basin is among the highest priority activities for solar system science. The mission's high priority stems from its role in addressing multiple science objectives outlined in this report, including understanding the interior of the Moon and impact history of the solar system. Though recent remote-sensing missions provide much valuable new data from orbit about the diversity of materials and the geophysical context of this important basin, achieving the highest-priority science objectives requires precision of age measurements to better than ± 20 million years and accuracy of trace elemental compositions to the parts-per-billion level, which is only achievable via sample return. The principal scientific reasons for undertaking a South Pole-Aitken Basin Sample Return mission are as follows:

- Determine the chronology of basin-forming impacts and constrain the period of late heavy bombardment in the inner solar system, and thus address fundamental questions of inner solar system impact processes and chronology;

- Elucidate the nature of the Moon’s lower crust and mantle by direct measurements of its composition and of sample ages;
- Characterize a large lunar impact basin through “ground truth” validation of global, regional, and local remotely sensed data of the sampled site;
- Elucidate the sources of thorium and other heat-producing elements in order to understand lunar differentiation and thermal evolution; and
- Determine ages and compositions of far-side basalts to determine how mantle source regions on the far side of the Moon differ from regions sampled by Apollo and Luna.

Landing on the Moon, collecting appropriate samples, and returning them to Earth requires a New Frontiers-class mission, which has been demonstrated through the 2003 decadal survey and the New Frontiers proposal process. The committee places very high priority on the return of at least 1 kg of rock fragments from the SPA region, selected to maximize the likelihood of achieving the above objectives. Such a mission is significantly enabled by recent orbital missions that have provided high-resolution surface images, allowing reduction in risk associated with appropriate site selection and hazard avoidance. Current technology for in situ instrumentation is not adequate for obtaining the required isotopic, geochemical, and mineral-chemical analyses on the Moon; terrestrial laboratories and instrumentation can do the requisite analyses, but expertise in the sample analysis must be sustained through core NASA R&A programs. A robotic lunar sample return mission has extensive feed forward to future sample return missions from other locations on the Moon as well as Mars and other bodies in the solar system.

New Missions

Flagship Class

The most recent report from the VEXAG details the community-based consensus on scientific priorities for the exploration of Venus.²⁵ Well over half of the science objectives and the suggested high-priority investigations to accomplish them target a deeper understanding of Venus’s complex climate system. Smaller Discovery and New Frontiers missions, while able to accomplish some of the highest priority VEXAG science objectives, do not have the capability to address all the interrelated aspects of climate (Figure 5.3). A flagship mission focused on studying the climate of Venus would answer many of the outstanding science questions that remain about the Venus climate system.

In 2009, NASA tasked the Venus Science and Technology Definition Team to define the science objectives for a possible flagship class mission to Venus with a nominal launch date in the mid-2020s. The resulting Venus Flagship Design Reference Mission (VFDRM)²⁶ addresses three overarching science goals:

1. Understand what Venus’s greenhouse atmosphere can tell us about climate change,
2. Determine how active Venus is (including the interior, surface and atmosphere), and
3. Determine where and when water, which appears to have been present in the past, has gone.

The VFDRM comprises synergistic measurements from two landers, two balloons, and a highly capable orbiter. However, while there are synergisms that can be realized by conducting these investigations within the same mission, much can be accomplished with multiple smaller (Discovery, New Frontiers or smaller Flagship Class) missions that address subsets of the VFDRM objectives, such as the Venus Climate Mission described below.

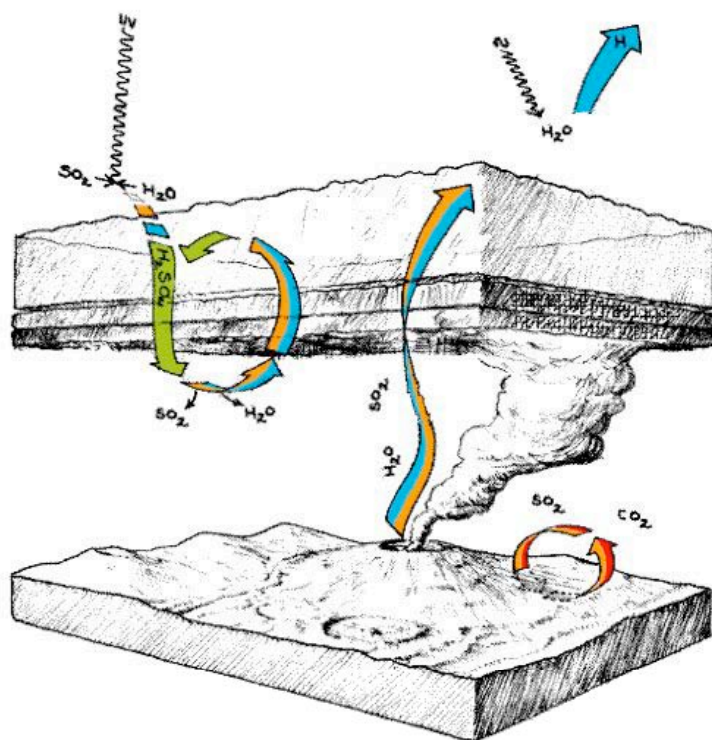

FIGURE 5.3 Venus's climate is controlled by interior processes (e.g., the rate of volcanism), processes within the atmosphere, and atmospheric escape processes. SOURCE: Courtesy David Grinspoon and Carter Emmart.

The Venus Climate Mission (VCM) will greatly improve our understanding of the current state and dynamics/evolution of the strong carbon dioxide greenhouse climate of Venus, providing fundamental advances in the understanding of and ability to model climate and global change on Earth-like planets. While the VISE mission focuses on the detailed characterization of the surface, deep atmosphere and their interaction, VCM provides three-dimensional constraints on the chemistry and physics of the middle and upper atmosphere in order to identify the fundamental climate drivers on Venus. VCM is a mission can only be accomplished through in situ, simultaneous measurements in Venus's atmosphere. The principal scientific objectives of the Venus Climate Mission are as follows:

- Characterize the strong carbon dioxide greenhouse atmosphere of Venus, including variability over longitude, solar zenith angle, altitude and time of the radiative balance, cloud properties, dynamics and chemistry of Venus's atmosphere.
- Characterize the nature and variability of Venus's superrotating atmospheric dynamics, to improve the ability of terrestrial general circulation models to accurately predict climate change due to changing atmospheric composition and clouds.
 - Constrain surface/atmosphere chemical exchange in the lower atmosphere.
 - Determine the origin of Venus's atmosphere.
 - Search for atmospheric evidence of recent climate change on Venus.
 - Understand implications of Venus's climate evolution for the long-term fate of Earth's climate, including if and why Venus went through radical climate change from a more Earth-like climate in the distant past, and when Earth might go through a similar transition.

Synergistic observations from an orbiter, a balloon, a mini-probe and two drop sondes will enable the first truly global 3-dimensional (and to a large extent 4-dimensional, including many measurements of temporal changes) characterization of Venus's atmosphere. The mission will return a dataset on Venus's radiation balance, atmospheric motions, cloud physics, and atmospheric chemistry and composition. The relationships and feedbacks among these parameters, such as cloud properties and radiation balance, are among the most vexing problems limiting the forecasting capability of terrestrial GCMs. Evidence will also be gathered for the existence, nature and timing of the suspected ancient radical global change from habitable, Earthlike conditions to the current hostile runaway greenhouse climate, with important implications for understanding the stability of climate and our ability to predict and model climate change on earth and extrasolar terrestrial planets. This mission does not require extensive technology development, and could be accomplished in the coming decade, providing extremely valuable data to improve our understanding of climate on the terrestrial planets.

New Frontiers-Class

Important contributions can be made to the goals for the study of the inner planets by a Lunar Geophysical Network.

Lunar Geophysical Network

The 2003 NRC decadal survey identified geophysical network science as a potential high-yield science mission concept. The importance of geophysical networks to both lunar and solar system science was strongly affirmed by subsequent reports.^{27,28,29} Deploying a global, long-lived network of geophysical instruments on the surface of the Moon to understand the nature and evolution of the lunar interior from the crust to the core will allow the examination of planetary differentiation that was essentially frozen in time at some 3-to-3.5 billion years ago. Such data (e.g., seismic, heat flow, laser ranging, and magnetic field/electromagnetic sounding) are critical to determining the initial composition of the Moon and the Earth-Moon system, understanding early differentiation processes that occurred in the planets of the inner solar system, elucidating the dynamical processes that are active during the early history of terrestrial planets, understanding the collision process that generated our unique Earth-Moon system, and exploring processes that are currently active at this stage of the Moon's heat engine.

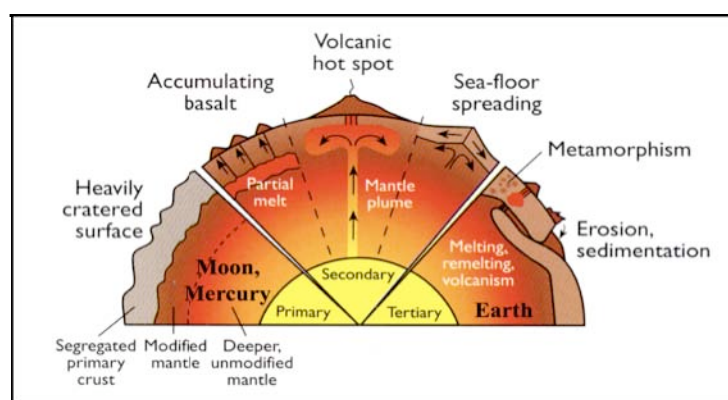

FIGURE 5.4 Understanding the interior of the Moon provides both a snapshot for the earliest stages of the interior evolution of a terrestrial planet and an end-member for understanding evolutionary pathways taken by planetary heat engines. SOURCE: J.W. Head III, Surfaces and interiors of the terrestrial planets, pp. 157-173 in *The New Solar System* (J.K. Beatty, C.C. Petersen, and A., Chaikin, eds.). Sky Publishing, Cambridge, Mass., Copyright 1999. Reprinted with permission of the Cambridge University Press.

Important scientific objectives that could be accomplished by a LGN mission are as follows:

- Determine the lateral variations, the structure, mineralogy, composition, and temperature of the lunar crust and upper mantle, the nature of the lower mantle, and the size, state, and composition of a lunar core to understand the formation of both primary and secondary crusts on terrestrial planets (Figure 5.4).
- Determine the distribution and origin of lunar seismic activity. Understanding the distribution and origin of both shallow and deep moonquakes will provide insights into the current dynamics of the lunar interior and its interplay with external phenomena (e.g., tidal interactions with Earth).
- Determine the global heat-flow budget for the Moon and the distribution of heat-producing elements in the crust and mantle in order to better constrain the thermal evolution of our only natural satellite.
- Determine the size of structural components (e.g., crust, mantle, and core) making up the interior of the Moon, including their composition and compositional variations to estimate bulk lunar composition and how they relate to that of Earth and other terrestrial planets, how the Earth-Moon system was formed, and how planetary compositions are related to nebular condensation and accretion processes.
- Determine the nature and the origin of the lunar crustal magnetic field to probe the thermal evolution of the lunar crust, mantle, and core, as well as the physics of magnetization and demagnetization processes in large basin-forming impacts.

The overarching goal of the LGN is to enhance knowledge of the lunar interior. The technology developed for this mission also feeds forward to the design and installation of robotically emplaced geophysical networks on other planetary surfaces. A four-node network would accomplish much of the science outlined above. Such a network could be emplaced or enhanced with international contributions of nodes, as with the ILN concept, providing opportunities for exploration synergies as well as cost savings among nations.

Summary

A combination of mission, research, and technology activities will advance the scientific study of the inner planets during the next decade. Such activities include the following:

- *Flagship missions*—The top and only priority for a flagship mission is the Venus Climate Mission, which would dramatically improve our understanding of climate on the terrestrial planets and provide an important context for comparison with Earth. This mission requires no new technology, can be accomplished in the next decade, and would serve as a key step toward more intensive Venus exploration in the future.
- *New Frontiers missions*—New Frontiers missions remain critical to a healthy program of mission activity throughout the inner solar system, providing opportunities for critical science in more challenging environments and for more comprehensive studies than can be supported under Discovery. A regular cadence of such missions is highly desirable. The committee point to three missions as being particularly important. They are, in priority order:
 1. Venus In Situ Explorer,
 2. South Pole-Aitken Basin Sample Return, and
 3. Lunar Geophysical Network.
- *Discovery missions*—Small missions remain an integral part of the exploration strategy for the inner solar system, with major opportunities for significant science return. A regular cadence of such

missions is needed. Such missions may include orbital, landed or mobile platforms that provide significant science return in addressing one or more of the fundamental science questions laid out earlier in this chapter.

- *Technology development*—The development of technology is critical for future studies of the inner planets. Robust technology development efforts are required to bring mission enabling technologies to TRL 6. The continuation of current initiatives is encouraged to infuse new technologies into Discovery and New Frontiers missions through the establishment of cost incentives. These could be expanded to include capabilities for surface access and survivability, particularly for challenging environments such as the surface of Venus and the frigid polar craters on the Moon. These initiatives offer the potential to dramatically enhance the scope of scientific exploration that will be possible in the next decade. In the long term, infusion of new technologies will also reduce mission cost, leading to an increased flight rate for competed missions and laying the groundwork for future flagship missions.

- *Research support*—A strong R&A program is critical to the health of the planetary sciences. Activities that facilitate missions and provide additional insight into the solar system are an essential component of a healthy planetary science program. An important opportunity for cross-disciplinary research exists concerning the climates of Venus, Mars, and Earth

- *Observing facilities*—Earth- and space-based telescopes remain highly valuable tools for the study of inner solar system bodies, often providing data to enable and/or complement spacecraft observations. Support for the building and maintenance of Earth-based telescopes is an integral part of solar system exploration. Chapter 10 contains a more complete discussion of observing facilities.

- *Data archiving*—Data management programs such as the PDS must evolve in innovative ways as the data needs of the planetary community grow. Chapter 10 contains a more complete discussion of archiving issues.

- *Deep space communication*—Systems must be maintained at the highest technical level to provide the appropriate pipeline of mission data as band-width demands increase with improved technology, as well as S-band capability to communicate from the surface of Venus. Chapter 10 contains a more complete discussion of communications issues.

- *International Cooperation*—The development of international teams to address fundamental planetary science issues, such as ILN and NLSI, is valuable. Continuing support by NASA for U.S. scientists to participate in foreign missions through participating scientist programs and Mission of Opportunity calls enables broader US participation in the growing international space community.

- *Education and outreach*—It is important that NASA strengthen both its efforts to archive past education and public outreach efforts and its evaluations and lessons-learned activities. Through such an archive, future education and public outreach projects can work forward from tested, evaluated curricula and exercises.

These mission priorities, research activities, and technology development initiatives will be assessed and prioritized in Chapters 9, 10, and 11, respectively.

BOX 5.1 Planetary Roadmaps

Roadmaps are important tools for laying out the exploration strategies for future exploration of the solar system, as has been demonstrated for Mars by the Mars Exploration Program Analysis Group. Such roadmaps include concepts for all mission classes, as well as identify supporting research, technology and infrastructure. Elements of an inner planets roadmap are outlined below.

For Mercury, the current MESSENGER mission will provide a wealth of new information that could further redefine our understanding of the planet and modify priorities for future missions. The planned ESA BepiColombo mission will augment those data and fill important data gaps. Given these missions, the next logical step for the exploration of Mercury would be a landed mission to perform in situ investigations, such as delineated in the committee's study of a Mercury lander concept. Additional Discovery missions and ground-based observations (e.g., Arecibo, Green Bank) will be important in addressing data gaps not filled by current and planned missions. Later Mercury missions would likely include establishment of a geophysical network and sample return.

The Venus Exploration Analysis Group has identified goals and objectives for the exploration of Venus, which will be met by future measurements from Earth, and by orbital, landed and mobile platforms. Currently ESA's Venus Express continues to focus on measurements of the atmosphere. These measurements were to have been augmented by JAXA's Akatsuki. Unfortunately, this spacecraft failed in its attempt to enter orbit around Venus and its current status is unclear. Venus Express and Akatsuki (if it can be salvaged) will add significantly to understanding the structure, chemistry and dynamics of the atmosphere. However, important gaps in atmospheric science key to understanding climate evolution will remain, requiring in situ measurements, such as can be performed during atmospheric transit by landers like VISE, using balloons, and/or drop sondes/probes. Significant new understanding of surface and interior processes on Venus will result from a landed geochemical mission such as VISE, as well as from orbital high-resolution imagery, topographic, polarimetric and interferometric measurements, which will also enable future landed missions. There is a critical future role for additional VISE-like missions to a variety of important sites, such as tessera terrain (e.g., the Venus Intrepid Tessera Lander concept described in Appendices D and G) that may represent early geochemically distinct crust. Later Venus missions would include establishment of a geophysical network, mobile explorers (e.g., the Venus Mobile Explorer concept described in Appendices D and G) and sample return, although these missions require technology development. While there remains significant scope for Discovery-class missions to Venus, more comprehensive flagship-class missions will be needed to address the long term goals for Venus exploration.

The Lunar Exploration Analysis Group has developed a comprehensive series of goals and objectives for the exploration of the Moon involving both robotic and human missions. In addition, recent and ongoing orbital missions have shaped a new view of the Moon and identified many opportunities for future exploration under Discovery and New Frontiers. The GRAIL mission, a recent Discovery selection, will soon launch to provide high-precision gravity data for the Moon, which will generate significant new insight into lunar structure and history. Launching on a similar timeframe, LADEE will determine the global density, composition, and time variability of the fragile lunar atmosphere before it is perturbed by further human activity, implementing a priority enunciated by the NRC report, *The Scientific Context for the Exploration of the Moon*.³⁰

Priority mission goals include sample return from the South Pole-Aitken Basin region and a lunar geophysical network, as identified in this chapter. Other important science to be addressed by future missions include the nature of polar volatiles (e.g., Lunar Polar Volatiles concept described in Appendices D and G), the significance of recent lunar activity at potential surface vent sites, and the reconstruction of both the thermal-tectonic-magmatic evolution of the Moon and the impact history of the inner solar system through the exploration of better characterized and newly revealed lunar terrains. Such missions may include orbiters, landers and sample return.

BOX 5.2 The Discovery Program's Value to Exploring the Inner Planets

The Discovery program continues to be an essential part of the exploration and scientific study of the inner planets. Their proximity to Earth and the Sun enable easy access by spacecraft in the Discovery class.

During the past decade inner planets science has benefited greatly from the Discovery program. Past and ongoing missions include:

- *MESSENGER*—The first mission to orbit Mercury; and
- *GRAIL*—An effort to use high-quality gravity field mapping of the moon to determine the moon's interior structure (scheduled for launch in 2011).

In addition, recent and planned missions to the Moon, although not Discovery missions, are generally equivalent to other missions in that program. The orbital LRO and impactor LCROSS missions address both exploration and science goals for characterizing the lunar surface and identifying potential resources, while LADEE will characterize the lunar atmosphere and dust environment.

The proximity and ready accessibility of the inner planets provides opportunities to benefit from the frequent launch schedule envisioned by this program. Although Discovery missions are competitively and not strategically selected, Mercury, Venus and the Moon offer many science opportunities for Discovery teams to seek to address. The most recent Discovery announcement of opportunity attracted over two dozen proposals, including a number of inner planets proposals.

At Mercury, orbital missions that build on the results from MESSENGER could characterize high-latitude, radar-reflective volatile deposits, map the chemistry and mineralogy of the surface, measure the composition of the atmosphere, characterize the stability and morphology of the magnetosphere, and precisely determine the long-term planetary rotational state. At Venus, platforms including orbiters, balloons, and probes could be used to study atmospheric chemistry and dynamics, surface geochemistry and topography, and current and past surface and interior processes. The proximity of the Moon makes it an ideal target for future orbital or landed Discovery missions, building on the rich scientific findings of recent lunar missions, and the planned GRAIL and LADEE missions. The variety of tectonic, volcanic and impact structures, as well as chemical and mineralogical diversity offer significant opportunity for future missions.

REFERENCES

1. The term inner planets is used here to refer to Mercury, Venus and the Moon. Whereas, the term terrestrial planets is used to refer to Earth, Mercury, Venus, Mars, and the Moon.
2. Although scientific and programmatic issues relating to Mars are described in Chapter 6, it is not always possible to entirely divorce martian studies from studies of the other terrestrial planets. Therefore, when issues concerning Mercury, Venus, or the Moon naturally touch upon corresponding issues relevant to Mars they are mentioned in the spirit of comparative planetology.
3. R. Jeanloz, D.L. Mitchell, A.L. Sprague, and I de Pater. 1995. Evidence for a basalt-free surface on Mercury and implications for internal heat. *Science* 268(5216):1455-1457, doi: 10.1126/science.7770770.
- D.T. Blewett, M.S. Robinson, B.W. Denevi, J.J. Gillis-Davis, J.W. Head, S.C. Solomon, G.M. Holsclaw, and W.E. McClintock. 2009. Multispectral images of Mercury from the first MESSENGER flyby: Analysis of global and regional color trends. *Earth Planet. Sci. Lett.* 285:272-282, doi: 10.1016/j.epsl.2009.02.021.

4. D.J. Lawrence, W.C. Feldman, J.O. Goldsten, T.J. McCoy, D.T. Blewett, W.V. Boynton, L.G. Evans, L.R. Nittler, E.G. Rhodes, and S.C. Solomon. 2010. Identification and measurement of neutron-absorbing elements on Mercury's surface, *Icarus*, in press, doi: 10.1016/j.icarus.2010.04.005.
5. J.L. Margot, S.J. Peale, R.F. Jurgens, M.A. Slade, and I.V. Holin. 2007. Large longitude libration of Mercury reveals a molten core. *Science* 316(5825):710-714, doi: 10.1126/science.1140514.
D.E. Smith, M.T. Zuber, R.J. Phillips, S.C. Solomon, G.A. Neumann, F.G. Lemoine, S.J. Peale, J.-L. Margot, M.H. Torrence, M.J. Talpe, J.W. Head III, S.A. Hauck II, C.L. Johnson, M.E. Perry, O.S. Barnouin, R.L. McNutt, Jr., and J. Oberst. 2010. The equatorial shape and gravity field of Mercury from MESSENGER flybys 1 and 2. *Icarus*, in press, doi:10.1016/j.icarus.2010.04.007.
6. B.J. Anderson, M.H. Acuña, H. Korth, M.E. Purucker, C.L. Johnson, J.A. Slavin, S.C. Solomon, and R.L. McNutt, Jr. 2008. The structure of Mercury's magnetic field from MESSENGER's first flyby. *Science* 321(5885):82-85, doi: 10.1126/science.1159081.
7. B.W. Denevi, M.S. Robinson, S.C. Solomon, S.L. Murchie, D.T. Blewett, D.L. Domingue, T.J. McCoy, C.M. Ernst, J.W. Head, T.R. Watters, and N.L. Chabot 2009. The evolution of Mercury's crust: A global perspective from MESSENGER. *Science* 324(5927):613-618.
J.W. Head, C.M. Weitz, and L. Wilson. 2002. Dark ring in southwestern Orientale Basin: Origin as a single pyroclastic eruption. *J. Geophys. Res.* 107:E1, doi: 10.1029/2000JE001438.
8. N. Mueller, J. Helbert, G.L. Hashimoto, C.C.C. Tsang, S. Erard, G. Piccioni, and P. Drossart. 2008. Venus surface thermal emission at 1 μm in VIRTIS imaging observations: Evidence for variation of crust and mantle differentiation conditions. *Journal of Geophysical Research* 113:E00B17, doi:10.1029/2008JE003225.
G.L. Hashimoto, M. Roos-Serote, S. Sugita, M.S. Gilmore, L.W. Kamp, R.W. Carlson, and K.H. Baines. 2008. Felsic highland crust on Venus suggested by Galileo Near-Infrared Mapping Spectrometer data. *J. Geophys. Res.* 113:E00B24, doi:10.1029/2008JE003134.
9. S.E. Smrekar, E.R. Stofan, N. Mueller, A. Treiman, L. Elkins-Tanton, J. Helbert, G. Piccioni, and P. Drossart. 2010. Recent hotspot volcanism on Venus from VIRTIS emissivity data. *Science* 328(5978):605-608, doi:10.1126/science.1186785.
10. T.R. Watters, S.C. Solomon, M.S. Robinson, J.W. Head, S.L. André, S.A. Hauck II, and S.L. Murchie. 2009. The tectonics of Mercury: The view after MESSENGER's first flyby. *Earth Planet. Sci. Lett.* 285(3-4):283-296.
B.W. Denevi, M.S. Robinson, S.C. Solomon, S.L. Murchie, D.T. Blewett, D.L. Domingue, T.J. McCoy, C.M. Ernst, J.W. Head, T.R. Watters, and N.L. Chabot. 2009. The evolution of Mercury's crust: A global perspective from MESSENGER. *Science* 324(5927):613-618.
J.W. Head, S.L. Murchie, L.M. Prockter, S.C. Solomon, C.R. Chapman, R.G. Strom, T.R. Watters, D.T. Blewett, J.J. Gillis-Davis, C.I. Fassett, J.L. Dickson, G.A. Morgan, and L. Kerber. 2009. Volcanism on Mercury: Evidence from the first MESSENGER flyby for extrusive and explosive activity and the volcanic origin of plains. *Earth Planet. Sci. Letters* 285: 227-242.
11. See, for example, K. Tsiganis, R. Gomes, A. Morbidelli, and H.F. Levison. 2005. Origin of the orbital architecture of the giant planets of the solar system. *Nature* 435:459-461, doi: 10.1038/nature03539.
12. S.E. Smrekar, E.R. Stofan, N. Mueller, A. Treiman, L. Elkins-Tanton, J. Helbert, G. Piccioni, and P. Drossart. 2010. Recent hotspot volcanism on Venus from VIRTIS emissivity data. *Science* 328(5978):605-608, doi:10.1126/science.1186785.
13. N. Mueller, J. Helbert, G.L. Hashimoto, C.C.C. Tsang, S. Erard, G. Piccioni, and P. Drossart. 2008. Venus surface thermal emission at 1 μm in VIRTIS imaging observations: Evidence for variation of crust and mantle differentiation conditions. *Journal of Geophysical Research* 113:E00B17, doi: 10.1029/2008JE003225.

14. G.L. Hashimoto, M. Roos-Serote, S. Sugita, M.S. Gilmore, L.W. Kamp, R.W. Carlson, and K.H. Baines. 2008. Felsic highland crust on Venus suggested by Galileo Near-Infrared Mapping Spectrometer data. *J. Geophys. Res.* 113:E00B24, doi: 10.1029/2008JE003134.
15. P.H. Schultz and P.D. Spudis. 1979. Evidence for ancient mare volcanism. *Proceedings Lunar Planetary Science Conference* 10:2899-2918.
- J.W. Head, C.M. Weitz, and L. Wilson. 2002. Dark ring in southwestern Orientale Basin: Origin as a single pyroclastic eruption. *J. Geophys. Res.* 107:E05001, doi: 10.1029/2000JE001438.
16. A.E. Saal, E.H. Hauri, M.L. Cascio, J.A. Van Orman, M.C. Rutherford, and R.F. Cooper, 2008 Volatile content of lunar volcanic glasses and the presence of water in the Moon's interior. *Nature* 454:192–195.
17. P.H. Schultz, M.I. Staid, and C.M. Pieters. 2006. Lunar activity from recent gas release. *Nature* 444:184-186.
18. M.C. Liang and Y.L. Yung. 2009. Modeling the distribution of H₂O and HDO in the upper atmosphere of Venus. *J. Geophys. Res.* 114:E00B28, doi:10.1029/2008JE003095.
19. F. Taylor and D. Grinspoon. 2009. Climate evolution of Venus. *Journal of Geophysical Research* 114:E00B40, doi:10.1029/2008JE003316.
20. See, for example, National Research Council, *Strategy for Exploration of the Inner Planets 1977-1987*, National Academy of Sciences, Washington, D.C., 1978.
21. National Research Council. 2003. *New Frontiers in the Solar System: An Integrated Exploration Strategy*. The National Academies Press, Washington, D.C.
22. National Research Council. 2008. *Opening New Frontiers in Space: Choices for the Next New Frontiers Announcement of Opportunity*. The National Academies Press, Washington, D.C.
23. See, for example, e.g., M.A. Bullock, D. Senske, and the VFDRM team, Venus flagship design reference mission (VFDRM), 2009, available at <http://vfm.jpl.nasa.gov/>.
24. National Research Council. 2008. *Opening New Frontiers in Space: Choices for the Next New Frontiers Announcement of Opportunity*. The National Academies Press, Washington, D.C.
25. S.S. Limaye and VEXAG Committee. 2009. *Pathways for Venus Exploration, Venus Exploration Analysis Group (VEXAG)*. Available at <http://www.lpi.usra.edu/vexag/reports/pathways1009.pdf>
- 26 M.A. Bullock, D. Senske, and the VFDRM team. 2009. Venus flagship design reference mission (VFDRM). Available at <http://vfm.jpl.nasa.gov/>.
27. National Research Council. 2007. *Scientific Context for Exploration of the Moon*. The National Academies Press, Washington, D.C.
28. NASA Advisory Council. 2007. *Workshop in Enabling Science in the Lunar Architecture*. Tempe, Ariz. Available at <http://www.lpi.usra.edu/meetings/LEA/>.
29. National Research Council. 2008. *Opening New Frontiers in Space: Choices for the Next New Frontiers Announcement of Opportunity*. The National Academies Press, Washington, D.C.
30. National Research Council. 2007. *Scientific Context for Exploration of the Moon*. The National Academies Press, Washington, D.C.

6

Mars: Evolution of an Earth-like World

Mars has a unique place in solar system exploration: it holds keys to many compelling planetary science questions and it is accessible enough to allow rapid, systematic exploration to address and answer these questions. The scientific objectives for Mars center on understanding the evolution of the planet as a system, focusing on the interplay between the tectonic and climatic cycles and the implications for habitability and life. These objectives are well aligned with the broad crosscutting themes of solar system exploration articulated in Chapter 3.

Mars presents an excellent opportunity to investigate the major question of habitability and life in the solar system. Conditions on Mars, particularly early in its history, are thought to have been conducive to formation of prebiotic compounds and potentially to the origin and continued evolution of life. Mars has also experienced major changes in surface conditions, driven by its thermal evolution, orbital evolution, and by changes in solar input and greenhouse gases, that have produced a wide range of environments. Of critical significance is the excellent preservation of the geologic record of early Mars, and thus the potential for evidence of prebiotic and biotic processes and how they relate to evolution of the planet as a system. This crucial early period is when life began on Earth, an epoch largely lost on our own planet. Thus, Mars provides the opportunity to address questions about how and whether life arose elsewhere in the solar system, about planetary evolution processes, and about the potential coupling between biological and geological history. Progress on these questions, important to both the science community and the public, can be made more readily at Mars than anywhere else in the solar system.

The spacecraft exploration of Mars began in 1965 with an exploration strategy of flybys, followed by orbiters, landers, and rovers with kilometers of mobility. This systematic investigation has produced a detailed knowledge of the planet's character, including global measurements of topography, geologic structure and processes, surface mineralogy and elemental composition, the near-surface distribution of water, the intrinsic and remnant magnetic field, gravity field and crustal structure, and the atmospheric composition and time-varying state (Figure 6.1).¹ The orbital surveys framed the initial hypotheses and questions and identified the locations where in situ exploration could test them. The surface missions—the Viking landers, Pathfinder, Phoenix, and the Mars Exploration Rovers—have acquired detailed information on surface morphology, stratigraphy, mineralogy, composition, and atmosphere-surface dynamics and confirmed what was strongly suspected from orbital data: Mars has a long-lasting and varied history during which water has played a major role.

A new phase of exploration began with the Mars Express and Mars Reconnaissance (MRO) orbiters, which carry improved instrumentation to pursue the questions raised in the earlier cycles of exploration. Among the discoveries (Table 6.1) is the realization that Mars is a remarkably diverse planet with a wide range of aqueous environments (Figure 6.2). The role of water and the habitability of the ancient environment will be further investigated by the Mars Science Laboratory (MSL), scheduled for launch in 2011, which will carry the most advanced suite of instrumentation ever landed on the surface of a planetary object (Box 6.1).

The program of Mars exploration over the past 15 years has provided a framework for systematic exploration, allowing hypotheses to be formulated and tested and new discoveries to be rapidly and effectively pursued with follow-up observations. In addition, the program has produced missions that support each other both scientifically and through infrastructure, with orbital reconnaissance and site selection, data relay, and critical event coverage significantly enhancing the quality of the in situ

missions.² Finally, this program has allowed the Mars science community to construct a logical series of missions that are each modest in scope and systematically advance our scientific understanding of Mars.

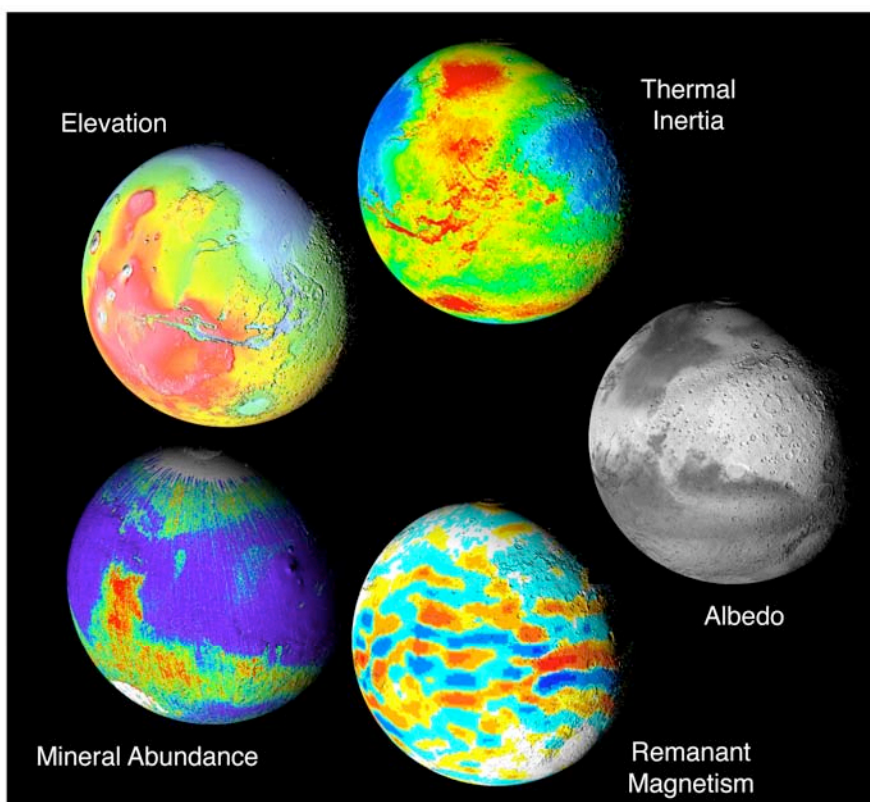

FIGURE 6.1 Examples of globally data sets highlight major accomplishments from multiple recent missions. SOURCE: Christensen, P.R., N.S. Gorelick, G.L. Mehall, and K.C. Murray, THEMIS Public Data Releases, Planetary Data System node, Arizona State University, <<http://themis-data.asu.edu>>.

TABLE 6.1 Major Accomplishments of Studies of Mars in the Past Decade

Major Accomplishment	Mission and/or Technique
Provided global mapping of surface composition, topography, remanent magnetism, atmospheric state, crustal structure	Mars Global Surveyor, Odyssey, Mars Express, Mars Reconnaissance Orbiter
Mapped the current distribution of near-surface ice and the morphologic effects of recent liquid water associated with near-surface ice deposits	Odyssey
Confirmed the significance of water through mineralogic measurements of surface rocks and soils	Mars Exploration Rovers, Phoenix
Demonstrated the diversity of aqueous environments, with major differences in aqueous chemistry, conditions, and processes	Mars Express, Odyssey, Mars Reconnaissance Orbiter, Mars Exploration Rovers
Mapped the three-dimensional temperature, water vapor, and aerosol properties of the atmosphere through time; found possible evidence of the presence of methane	Mars Global Surveyor, Odyssey, Mars Express, Mars Reconnaissance Orbiter and ground-based telescopes

BOX 6.1 Mars Science Laboratory

Scheduled to launch in the fall of 2011, Mars Science Laboratory is an advanced rover designed to follow the highly successful Mars Exploration Rovers, Spirit and Opportunity. Its primary focus is on assessing the habitability of geochemical environments identified from orbit where water-rock interactions have occurred and preservation of biosignatures is possible. MSL, weighing nearly a metric ton, carries a sophisticated suite of instruments for remote and in-situ rock/soil analysis, including x-ray diffraction, high precision mass spectroscopy, laser induced breakdown spectroscopy, alpha-proton x-ray spectroscopy, and a suite of cameras including microscopic imaging at ten-micron resolution. This analysis suite will provide detailed mineralogy and elemental composition, including the ability to assess light elements such as carbon, hydrogen, oxygen and their isotopes. The mission will also demonstrate the sky crane precision landing system, long-term surface operations, and long-range mobility.

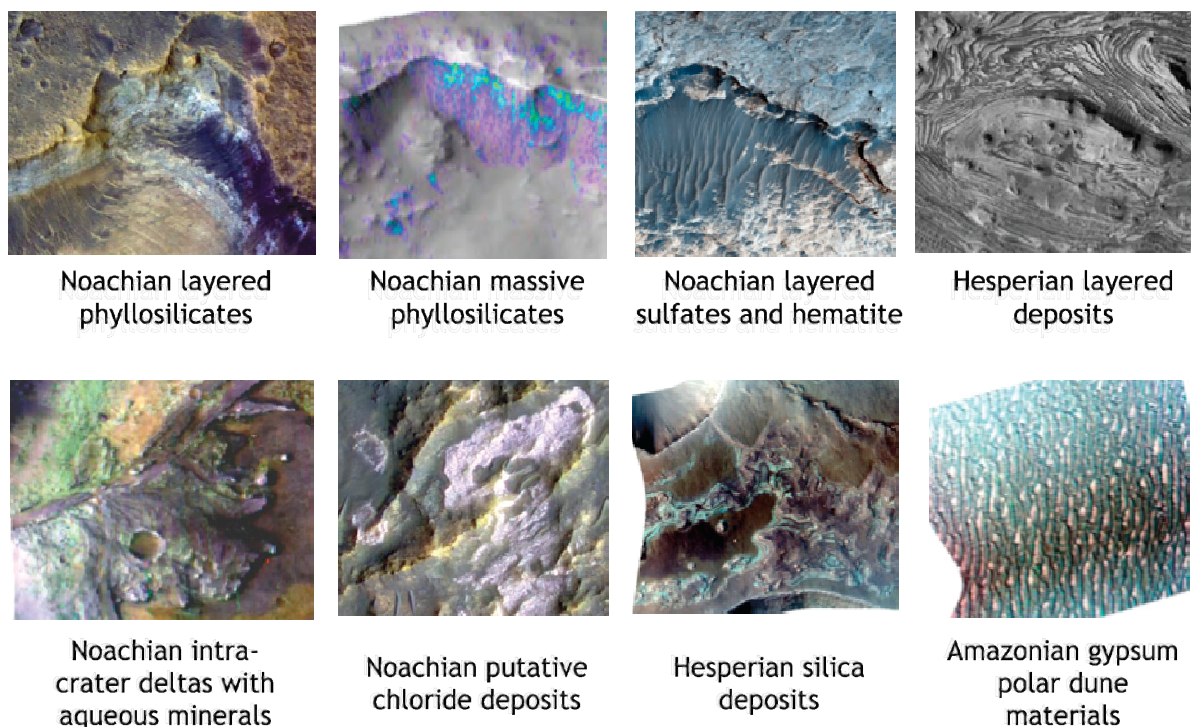

FIGURE 6.2 Examples of the diversity of environments and their mineralogy and morphology. SOURCE: Adapted from S. Murchie, A. McEwen, P. Christensen, J. Mustard, and J.-P. Bibring, Discovery of Diverse Martian Aqueous Deposits from Orbital Remote Sensing, presentation from the Curation and Analysis Planning Team for Extraterrestrial Materials Workshop on Ground Truth from Mars, Science Payoff from a Sample Return Mission, April 21-23, 2008, Albuquerque, New Mexico, available at <http://www.lpi.usra.edu/captem/msr2008/presentations/>.

Over the past decade the Mars science community, as represented by the Mars Exploration Program Analysis Group (MEPAG), has formulated three major science themes that pertain to understanding Mars as a planetary system:

- Life—Understand the potential for life elsewhere in the universe;
- Climate—Characterize the present and past climate and climate processes; and
- Geology—Understand the geological processes affecting Mars’s interior, crust, and surface.

From these themes, MEPAG has derived key, overarching science questions that drive future Mars exploration. These include the following:

- What are the nature, ages, and origin of the diverse suite of geologic units and aqueous environments evident from orbital and landed data, and were any of them habitable?
- How, when, and why did environments vary through Mars history, and did any of them host life or its precursors?
- What are the inventory and dynamics of carbon compounds and trace gases in the atmosphere and surface, and what are the processes that govern their origin, evolution, and fate?
- What is the present climate and how has it evolved on time scales of 10 million years, 100 million years, and 1 billion years?
- What are the internal structure and dynamics and how have these evolved over time?

The next decade holds great promise for Mars exploration. The MSL rover (Box 6.1), scheduled for launch in 2011, will significantly advance our knowledge of surface mineralogy and chemistry at a site specifically selected to provide insight into aqueous processes. The MAVEN mission currently in development and the ESA/NASA ExoMars Trace Gas Orbiter (TGO) will provide major new insights into the state and evolution of the Mars atmosphere. Following these missions the highest priority science goal will be to address in detail the questions of habitability and the potential origin and evolution of life on Mars.

The major focus of the next decade will be to initiate a Mars sample-return campaign, beginning with a rover mission to collect and cache samples, followed by missions to retrieve these samples and return them to Earth. It is widely accepted within the Mars science community that analysis of carefully selected samples from sites that have the highest scientific potential that are returned to Earth for intense study using advanced analytical techniques will provide the highest scientific return on investment for understanding Mars as a planetary system.

These samples can be collected and returned to Earth in a sequence of three missions that collect the samples, place them into Mars orbit, and return them to Earth. This modular approach is scientifically, technically, and programmatically robust, with each mission possessing a small number of discrete engineering challenges, and multiple sample caches providing resiliency against failure of subsequent elements. This modular approach also allows the sample return campaign to proceed at a pace determined by prioritization within the solar system objectives and by available funding. The study of Mars as an integrated system is so scientifically compelling that it will continue well beyond the coming decade, with future missions implementing geophysical and atmospheric networks, providing in situ studies of diverse sites, and additional sample returns that build on the coming decade’s discoveries.

All three of the crosscutting science themes for the exploration of the solar system include Mars, and studying Mars is vital to answering a number of the priority questions in each of them. The Building New Worlds theme includes the question “what governed the accretion, supply of water, chemistry, and internal differentiation of the inner planets and the evolution of their atmospheres, and what roles did bombardment by large projectiles play?” Mars is central to the Planetary Habitats theme which also includes two questions: “what were the primordial sources of organic matter, and where does organic synthesis continue today?” and “beyond Earth, are there modern habitats elsewhere in the solar system with necessary conditions, organic matter, water, energy, and nutrients to sustain life, and do organisms

live there now?”—both key components of Mars’s scientific exploration. The Workings of the Solar System theme includes the question “can understanding the roles of physics, chemistry, geology, and dynamics in driving planetary atmospheres and climates lead to a better understanding of climate change on Earth?” Mars’s climate has transpired from an early, warm, wet environment to its current state of a cold, dry planet with a thin atmosphere; its study can shed light on the evolution, and perhaps future, of Earth’s own climate. Most like Earth in its atmosphere, climate, geology, and surface environment, Mars plays a central role in the broad question as to “how have the myriad chemical and physical processes that shaped the solar system operated, interacted, and evolved over time?”

SCIENCE GOALS FOR THE STUDY OF MARS

The Mars science community, through MEPAG, has worked to establish consensus priorities for the future scientific exploration of Mars.³ One overarching theme is to understand whether life arose in the past and persisted to the present within the context of a differentiated rocky planet (deep interior, crust, and atmosphere) that has been strongly influenced by its interior evolution, solar evolution and orbital dynamics. Parallel investigations among multiple disciplines are required to understand how habitable environments and life might have developed on a dynamic planet where materials and processes have been closely coupled. The Mars science goals embrace this approach by articulating an interdisciplinary research program that drives a multi-decadal campaign of Mars missions. These goals include multiple objectives that embody the strategies and milestones needed to understand an early wet Mars, a transitional Mars, and the more recent and modern frozen, dry Mars. Ultimately these efforts will create a context of knowledge for understanding whether martian environments ever sustained habitable conditions and life.

Building on the work of MEPAG, the committee has established three high priority science goals for the exploration of Mars in the coming decade. These goals are:

- **Determine If Life Ever Arose on Mars**—Does life exist, or did it exist, elsewhere in the universe? This is perhaps one of the most compelling questions in science, and Mars is the most promising and accessible place to begin to begin the search. If successful it will be important to know where and for how long life evolved, and how the development of life relates to the planet’s evolution.
- **Understand the Processes and History of Climate**—Climate and atmospheric studies remain a major objective of Mars exploration. They are key to understanding how the planet may have been suited for life and how major parts of the surface have been shaped. In addition, studying Mars’s atmosphere and the evolution of its climate at various timescales is directly relevant for our understanding of the past, present, and future climate of Earth. Finally, characterizing Mars’s environment is also necessary for the safe implementation of future robotic and human spacecraft missions.
- **Determine the Evolution of the Surface and Interior.** Insight into the composition, structure, and history of Mars is fundamental to understanding the solar system as a whole, as well as providing context for the history and processes of our own planet. Geological and geophysical investigations will shed light on critical environmental aspects such as heat flow, loss of a global magnetic field, pathways of water-rock interaction, and sources and cycling of volatiles including water and carbon species (e.g. carbon dioxide and hydrocarbons). In contrast to Earth, Mars appears to have a rich and accessible geological record of the igneous, sedimentary, and cratering processes that occurred during the early solar system history. Geophysical measurements of Mars’s interior structure and heat flow, together with detailed mineralogic, elemental, and isotopic data from a diverse suite of martian geological samples, are essential for determining the chemical and physical processes that have operated through time on this evolving, Earth-like planet.

Subsequent sections examine each of these goals in turn.

DETERMINE IF LIFE EVER AROSE ON MARS

The prime focus of this goal is to determine if life is or was present on Mars. If life was there we must understand the resources that support or supported it. If life never existed yet conditions appear to have been suitable for formation and/or maintenance of life, a focus would then be to understand why life did not originate. A comprehensive conclusion about the question of life on Mars will necessitate understanding the planetary evolution of Mars and whether Mars is or could have been habitable, using multi-disciplinary scientific exploration at scales ranging from planetary to microscopic. The strategy adopted to pursue this goal has two sequential science steps: assess the habitability of Mars on an environment-by-environment basis using global remote sensing observations; and then test for prebiotic processes, past life, or present life in environments that can be shown to have high habitability potential. A critical means to achieve both objectives is to characterize martian carbon chemistry and carbon cycling.

Therefore, the committee's specific objectives to pursue the life goal are to as follows:

- Assess the past and present habitability of Mars,
- Assess whether life is or was present on Mars in its geochemical context, and
- Characterize carbon cycling and prebiotic chemistry.

Subsequent sections examine each of these objectives in turn, identifies critical questions to be addressed and future investigations and measurements that could provide answers.

BOX 6.2 Biosignatures

Life can be defined as essentially a self-sustaining system capable of evolution. But to guide the search for signs of life on Mars requires a working concept of life that helps to identify its key characteristics and its environmental requirements. Biosignatures are features that can be unambiguously interpreted as evidence of life and so provide the means to address fundamental questions about the origins and evolution of life. Types of biosignatures include morphologies (e.g., cells, and plant or animal remnants), sedimentary fabrics (e.g., laminations formed by biofilms), organic molecules, biominerals (e.g., certain forms of magnetite),⁴ elemental abundances, and stable isotopic patterns. Because some biosignatures are preserved over geologic time scales and in environments that are no longer habitable, they are important targets of exploration. It is not unreasonable to anticipate that any martian life might differ significantly from life on Earth, though Earth's environments have been more similar to those on Mars than to the environments of any other object in the solar system. Moreover, Mars and Earth may have exchanged life forms through impact ejecta. Any martian life may reasonably be assumed to have shared at least some of its basic attributes with life as we know it, which implies that any martian life also requires liquid water, carbon-based chemistry, and electron transfer processes.^{5,6}

Our working concept of life should also identify environmental conditions that are most conducive to life. A habitable environment must sustain liquid water at least intermittently and also allow key biological molecules to survive. The elements carbon, hydrogen, nitrogen, oxygen, phosphorus, and sulfur (CHNOPS) must be available, as they are essential for forming the covalently bonded compounds of all known life. Organic compounds are therefore key targets, with the caveat that martian and Earthly life might have employed different compounds. Energy drives metabolism and motility, and must be available from, for example, light or energy-yielding chemical reactions.⁷ Finally, the rates of environmental changes must not exceed rates at which life could adapt.⁸

Even if habitable environments supported the origination and evolution of life on Mars, the right set of environmental conditions is required in order to preserve biosignatures. The study of fossilization processes will be as important for Mars as it has been for Earth.⁹ The preservation of biosignatures is critically sensitive to the diagenetic processes that control preservation and, paradoxically, the very

characteristics (water, gradients in heat, chemicals, and light, and oxidant supply) that make so many environments habitable also cause them to be destructive to biosignature preservation. There are, however, habitable environments with geochemical conditions that favor very early mineralization that facilitate spectacular preservation. Authigenic silica, phosphate, clay, sulfate, and less commonly, carbonate precipitation are all known to promote biosignature preservation.¹⁰ The search for environments that have been *both* habitable as well as favorable for preservation can be optimized by pursuing an exploration strategy that focuses on the search for “windows of preservation”, remembering that Mars may indeed have its own uniquely favorable conditions.

Assess the Past and Present Habitability of Mars

Understanding whether a past or present environment could sustain life will include establishing the distribution of water, its geological history and the processes that control its distribution, identifying and characterizing phases containing C, H, O, N, P and S, and determining the available energy sources.

Recent exploration has confirmed that the surface of Mars today is cold, dry, chemically oxidizing, and exposed to intense solar ultraviolet radiation. These factors probably limit or even prohibit any life near its surface, although liquid water might occur episodically near the surface as dense brines or associated with melting ice.¹¹

Mars’s subsurface appears to be more hospitable. With mean annual surface temperatures close to 215 K at the equator and 160 K at the poles, a thick cryosphere could extend to a depth of several kilometers. Hydrothermal activity is likely in past or present volcanic areas, and even the background geothermal heat flux could drive water to the surface. At depths below a few kilometers, warmer temperatures would sustain liquid water in pore spaces, and a deep-subsurface biosphere is possible provided that nutrients are accessible and water can circulate.¹²

Biotic and abiotic pathways for the formation of complex organic molecules require an electron donor closely coupled to carbon in a form suitable to serve as an electron acceptor. On Mars, igneous minerals containing ferrous iron and/or partially reduced sulfur (e.g., olivine and pyrrhotite) are potential electron acceptors for reduction of carbon. The report of methane in the martian atmosphere contends that an active source is required to balance its destruction (its photochemical lifetime is <300 years).¹³ Any sources would likely reside in the subsurface and might include volcanic emissions, low-temperature rock-water reactions, microorganisms, or gas from the thermal degradation of organic matter.

Climate changes in the recent geological past might have allowed habitable conditions to arise episodically in near-surface environments. For example, Mars undergoes large changes in its obliquity (i.e., the tilt of its polar axis). At present the obliquity ranges from 23 to 27°, with values as high as 46° during the last 10 million years.¹⁴ At these higher obliquities, the water content of the atmosphere is likely higher, ground ice is stable closer to the equator, and surface ice may be transferred from the poles to lower latitudes.¹⁵

Past Habitable Environments and Life

Recent observations confirm that conditions in the distant past were probably very different from present conditions, with wetter and warmer conditions prior to about 3.5 billion years ago (the oldest definitive evidence of life on Earth is at least 3.7 billion years old). This evidence includes valley networks with relatively high drainage densities, evaporites and groundwater fluctuations,¹⁶ clay minerals, hydrothermally altered rocks, deltas, and large inferred surface erosion rates (Figure 6.3).¹⁷ Early Mars also witnessed extensive volcanism and high impact rates. The formation of large impact basins likely

developed hydrothermal systems and hot springs that might have sustained locally habitable environments.¹⁸

Since ~3.5 billion years ago, rates of weathering and erosion appear to have been very low and the most characteristic fluvial features are outflow channels formed by the catastrophic release of near-surface water.¹⁹ Groundwater is likely to be stable at greater depths and it might sustain habitable environments. In all epochs, the combination of volcanism and water-rich conditions might have sustained hydrothermal systems in which life could have thrived.

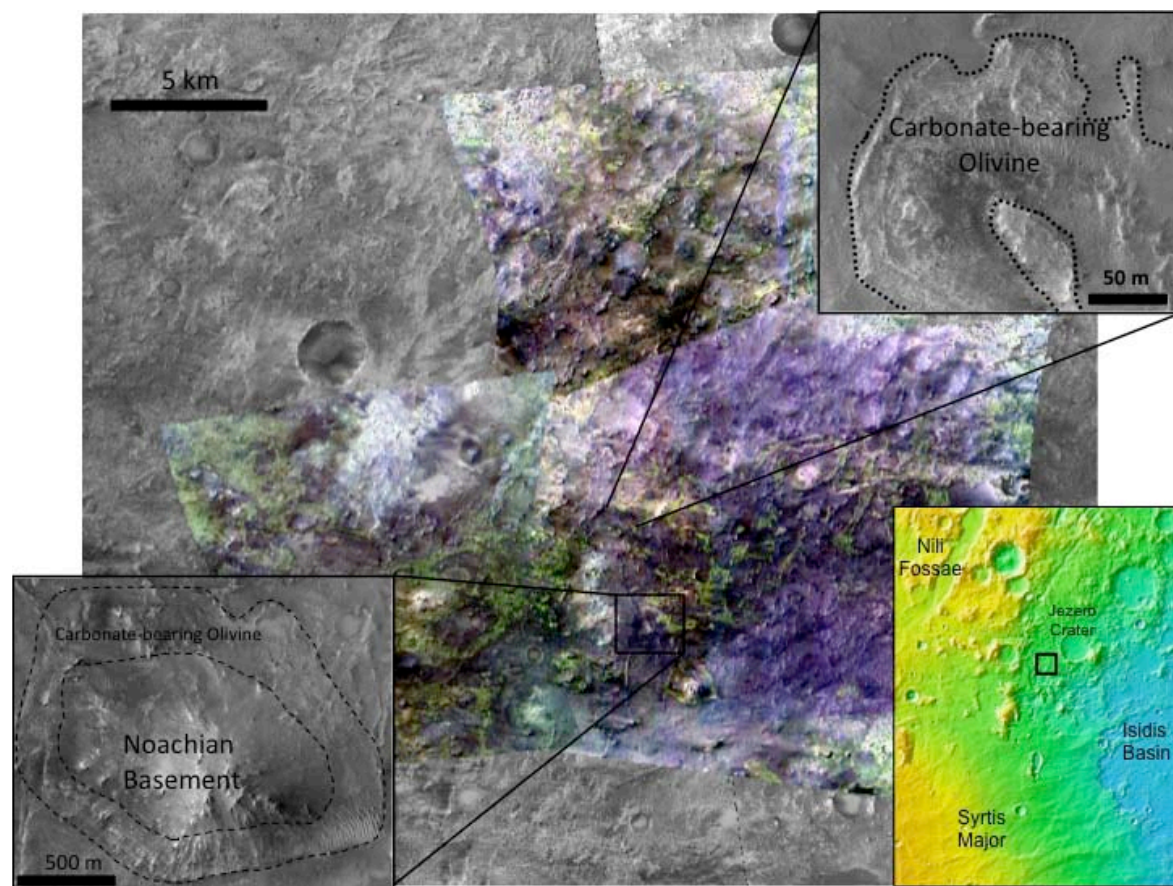

FIGURE 6.3 Diverse mineralogy observed with CRISM data formed by water-related processes and indicative of potentially habitable environments. SOURCE: B.L. Ehlmann and J.F. Mustard, Stratigraphy of the Nili Fossae and the Jezero Crater Watershed: A Reference Section for the Martian Clay Cycle, presentation at the First International Conference on Mars Sedimentology and Stratigraphy, April 19-21, 2010, El Paso, Texas, #6064, Lunar and Planetary Science Conference 2010. Lunar and Planetary Institute.

Important Questions

Some important questions concerning the past and present habitability of Mars include the following:

- Which accessible sites on Mars offer the greatest potential for having supported life in the past? How did the major factors that determine habitability—duration and activity of liquid water, energy

availability, physicochemical factors (temperature, pH, Eh, fluid chemistry), and availability of biogenic elements—vary among environments, and how did they influence the habitability of different sites?

- Which accessible sites favor preservation of any evidence of past habitable environments and life? How did the major factors that affect preservation of such evidence—for example aqueous sedimentation and mineralization, oxidation, radiation—vary among these sites?
- How have the factors and processes that give rise to habitable conditions at planetary and local scales changed over the long term in concert with planetary and stellar evolution?

Future Directions for Investigations and Measurements

Central to addressing habitability-related questions is searching for future landing sites that have both high habitability and biosignatures preservation potential (Box 6.2). Key here is identifying accessible rocks that show evidence for formation in aqueous environments such as fluvial, lacustrine, or hydrothermal systems.²⁰ An additional requirement is to be able to place the rock exposures in a stratigraphic framework that will allow reconstruction of past environmental conditions.²¹ Another key aspect in understanding present and past habitability is to characterize the current geologic activity of the martian interior. The long-term evolution of geologic processes, habitable environments, and life on Earth have been closely linked. Accordingly, geophysical observations that contribute to our understanding of the martian interior are important to the search for signs of martian life.

Ultimately our best understanding of present and past habitability will await the return to Earth of carefully selected samples from sites that have the highest scientific potential for analysis in terrestrial laboratories. Analyses of returned samples in Earth-based laboratories are essential in order to establish the highest confidence in any potential martian biosignatures and to interpret fully the habitable environments in which they were formed and preserved.^{22,23}

Key technological developments for surface exploration and sampling include modest-sized rovers capable of selecting samples and documenting their context. These rovers should include imaging and remote-sensing spectroscopy adequate to establish local geologic context and to identify targets. Suggested capabilities include surface abrasion tool(s), arm-mounted sensors, and a rock core caching system to collect suites of samples that meet the appropriate standards.²⁴ The in situ measurements used to select samples for return to Earth must go beyond identifying locations where liquid water has occurred.²⁵ They should also characterize the macroscopic and microscopic fabrics of sedimentary materials, be capable of detecting organic molecules, reconstruct the history of mineral formation as an indicator of preservation potential and geochemical environments, and determine specific mineral and chemical compositions as indicators of organic matter or coupled redox reactions characteristic of life.

Also essential to better understand the geochemistry of martian environments and the compositional and morphologic signatures these different environments produce is the continuation of a robust R&A program. Theoretical, laboratory, and terrestrial analog studies should develop models, analysis approaches, and instrumentation to interpret ancient environments from orbital, in situ, and returned sample data^{26,27,28}

Assess Whether Life is or Was Present on Mars and Characterize Carbon Cycling and Prebiotic Chemistry in a Geochemical Context

Assessing whether life is or was present on Mars will include characterizing complex organics, the spatial distribution of chemical and isotopic signatures, the morphology of mineralogical signatures, and identifying temporal chemical variations requiring life. Characterizing the carbon cycle will include determining the distribution and composition of organic and inorganic carbon species, characterizing the distribution and composition of inorganic carbon reservoirs through time, characterizing the links

between C and H, O, N, P, and S, and characterizing the preservation of reduced carbon compounds on the near-surface through time.

Organic and inorganic chemical reactions in early planetary environments pioneered the pathways that, on Earth, ultimately led to the origins of life. Organic compounds may have formed on early Mars through energetic reactions in reducing atmospheres, mineral-catalyzed chemical reactions, transient reactions caused by bolide impacts, and delivery of comets, meteorites, and interplanetary dust. The challenge is first to find organic matter and any redox-sensitive minerals and compounds, and then to characterize the conditions and processes that determined their composition. The Mars Science Laboratory is specifically designed to address many of these questions, and it is expected that significant progress will come from the MSL results.

Important Questions

Some important questions concerning whether life is or was present on Mars and the characterization of carbon cycling and prebiotic chemistry in a geochemical context include the following:

- Can evidence of past (or present) life in the form of organic compounds, aqueous minerals, cellular morphologies, biosedimentary structures, or patterns of elemental and mineralogical abundance be found at sites that have been carefully selected for high habitability and preservation potential?
- Do habitable environments exist today that may be identified by atmospheric gases, exhumed subsurface materials, or geophysical observations of the subsurface? Does life exist today, as evidenced by biosignatures, atmospheric gases, or other indicators of extant metabolism?

Future Directions for Investigations and Measurements

To address these key life questions, a broad range of mineralogic, elemental, isotopic, and textural measurements must be made of a diverse suite of martian rocks from well characterized sites that have high habitability potential. Deposits formed by aqueous sedimentation, hydrothermal activity, or aqueous alteration are important targets in the search for life. These deposits typically contain assemblages of materials that indicate geologic (and biologic?) processes. Accordingly, a “sample suite” is defined as the set of samples required to determine the key processes that formed them and, in turn, to assess any evidence of habitable environments or life. Many of the specific investigations and measurements overlap with those necessary to determine the geologic context and understand the potential for habitability described earlier, including technological development of modest-sized rovers capable of selecting samples and documenting their context along with the development of critical sample selection criteria and analysis instrumentation. Additionally preparation of return to Earth of carefully selected samples from sites with the highest scientific potential will mandate establishing curation methodologies needed to accommodate the contamination, alteration and planetary protection challenges posed by the complex martian returned samples.

A direct way to search for extant life is to map the distribution of atmospheric trace gases as will be done by the ESA-NASA Trace Gas Orbiter. Both biotic and abiotic processes involving water in subsurface environments can produce gases that escape into the atmosphere. Measurements of the composition, abundances, variability, and formation processes of atmospheric trace gases will allow the separation of potential geologic and biologic sources.

Finally support of a robust R&A program is crucial to understand better the interactions between organisms and their geological environments and their biosignatures. Terrestrial analog studies should test instrumentation, develop techniques for measuring biosignatures under martian conditions, and conduct technological proof-of-concept studies.

UNDERSTAND THE PROCESSES AND HISTORY OF CLIMATE

The fundamental scientific questions that underlie this goal are how the climate of Mars has evolved over time to reach its current state, and what processes have operated to produce this evolution. The climate history of Mars can be divided into three distinct epochs:

1. Modern, operating under the current obliquity;
2. Recent past, operating under similar pressures and temperatures but over a range of orbital variations (primarily obliquity); and
3. Ancient, when the atmospheric pressure and temperature may have been substantially higher than at present and liquid water may have been stable on the surface, either intermittently or for extended periods.

The specific objectives to pursue the climate goal are to:

- Characterize Mars's atmosphere, present climate, and climate processes under both current and different orbital configuration; and
- Characterize Mars's ancient climate and climate processes.

Subsequent sections examine each of these objectives in turn, identifies critical questions to be addressed and future investigations and measurements that could provide answers.

Understanding the current climate includes investigating the processes controlling the present distributions of water, carbon dioxide, and dust, determining the production/loss, reaction rates, and global distribution of key photochemical species, and understanding how volatiles and dust exchange between surface and atmospheric reservoirs. Understanding past climates includes determining how the composition of the atmosphere has evolved to its present state, the chronology of compositional variability, and the record of climatic change expressed in the surface stratigraphy and morphology. The ancient climate can be addressed by determining the escape rates of key species and their correlation with seasonal and solar variability, the influence of the magnetic field, the physical and chemical records of past climates, and the evolution of the isotopic, noble gas, and trace gas composition through time.

Mars's current climate system is complex and highly variable because the atmospheric circulation is coupled to three cycles:

- The dust cycle—dust lifted by the wind modifies the atmosphere's radiative properties;
- The carbon dioxide cycle—the atmosphere condenses and sublimates at seasonal polar caps and causes planetary-scale transport and pressure cycles; and
- The water cycle—water vapor is transported by the atmosphere between surface reservoirs, allowing the formation of clouds, hazes and frost.

The atmosphere is also the location of an active photochemistry coupled to these cycles and to the atmospheric dynamics, and must be taken into account to understand the development of habitable near-surface environments. Photochemistry and dynamics are especially vigorous in the upper martian atmosphere (thermosphere and ionosphere), and an understanding of these processes is critical to understanding the loss of Mars's upper atmosphere to space, which has probably controlled Mars long-term climate evolution and testing Earth-based theories in meteorology and aeronomy.

Observing and characterizing the present-day climate system is key for understanding the past. Two concepts of past climate (or "paleoclimate") must be distinguished for Mars. For modern and transitional (recent) Mars time frames it appears that the climate was periodically different from what it is today because of the oscillations of Mars orbit and rotation parameters. For ancient Mars the observations of the geology and mineralogy of the oldest surfaces provide evidence that there was abundant liquid water or brines on the martian surface either episodically or for extended periods of time.

Characterize Mars's Atmosphere, Present Climate, and Climate Processes Under Both Current and Different Orbital Configuration

A multi-year record of the seasonal cycles of water, carbon dioxide and dust (including episodic hemispheric and global dust events) and temperature is becoming available.²⁹ The record reveals complex interannual variability but is not extensive enough yet to identify regimes and understand the patterns and the controlling processes. Comparisons of these observations with numerical climate model predictions help to explain some processes, but often raise questions. For instance, the occurrence of global dust events some years and not others is not yet understood. Recent observations from Mars Global Surveyor, Mars Reconnaissance Orbiter, Mars Express, and Phoenix have also shown puzzling structures in the airborne dust vertical profiles, unexpected water vapor distributions, and surprising precipitating ice clouds.³⁰

The carbon dioxide cycle itself is more complex than anticipated, with a condensation phase controlled by atmospheric precipitation, subsurface heating and non-condensable gas enrichment and a sublimation phase characterized by the formation of high-velocity carbon dioxide vents that erupt sand-sized grains in jets able to form spots and control the polar cap albedo.³¹ The residual carbon dioxide ice cap near the south pole has been found to lie on a water ice substrate, but appears to be only a few meters thick.³² This discovery is surprising, because models suggest that it should either grow thick or disappear on a decadal timescale, unless it is the product of climate variations on such timescales, and because its thinness indicates that the readily available carbon dioxide reservoir may be smaller than previously thought.³³

The atmospheric circulation has been observed using mostly remote measurements of the temperature at elevations between 0 and 60 km. Recent observations covering the middle martian atmosphere (60-130 km) by both MCS (<90 km) and SPICAM (70-130 km, but with a very limited sampling) have revealed a very active dynamic atmosphere.³⁴

Among the most striking recent findings on the Mars atmosphere is the report of the detection of methane.³⁵ Its very presence would suggest an active subsurface source, as discussed in relation to the goals of life and geology. Reported variations in space and time, still controversial, require a considerable source (even by Earth geological standards) and the destruction of methane by very efficient chemical processes which must affect methane much more strongly than other known reactive species such as ozone or carbon monoxide.³⁶

In the past decade, new studies based on geomorphology, neutron spectroscopy, radar sounding, and in situ observations, combined with numerical modelling of the global climate, have demonstrated that the same climate system observed today can transport volatiles back and forth between the polar and low-latitude regions in response to orbital and obliquity variations.³⁷ These processes have created an array of glacial landforms at most martian latitudes, including debris covered icy landforms, polar layered deposits, and a ground ice mantle extending from the mid-latitudes to the poles (Figure 6.4). Major aspects of the climatic processes involved remain poorly understood. The apparent ages of the icy landforms are difficult to reconcile with or relate to the polar stratigraphy and specific climate processes. The origin of the latitude dependant ice mantle is still debated; is it the remnant of past ice precipitation,³⁸ or does it accumulate due to the diffusion of water vapour into ground pores?³⁹

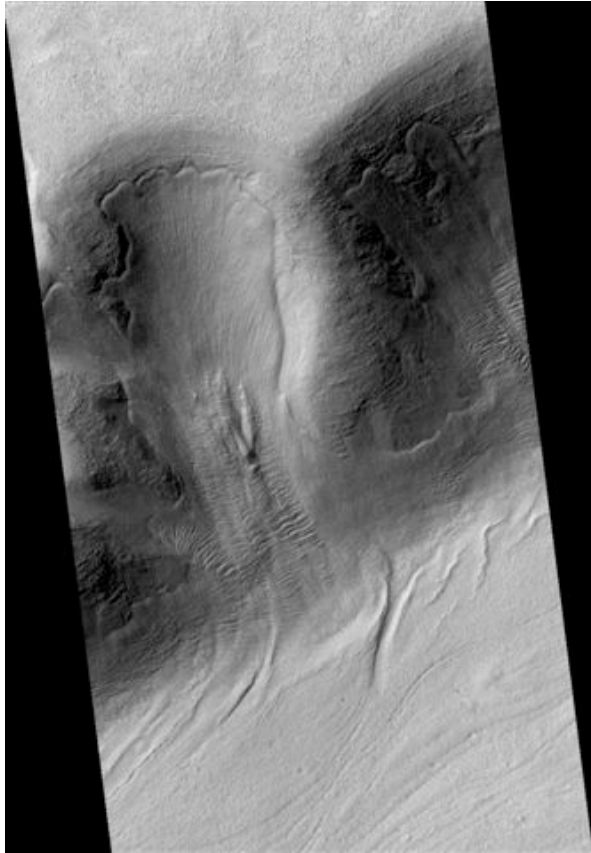

FIGURE 6.4 Examples of recent climate changes seen in the surface morphology. The image is 3.05 km wide. SOURCE: NASA/JPL.

Important Questions

Some important questions concerning Mars's atmosphere, present climate, and climate processes under both current and different orbital configuration include the following.⁴⁰

- What are the processes controlling the variability of the present-day climate? What is the four-dimensional wind structure of the martian atmosphere from the surface boundary layer to the upper atmosphere? What are the primary causes behind the occurrence of global dust events? What are the processes coupling the CO₂, dust and water cycles?
- What is the distribution of chemical species in the atmosphere and what are their sources and sinks? Do unexpected short-lived trace gases indicate a subsurface activity or even the presence of life, currently or in the past? What was the role of volcanic gases and aerosols in controlling the atmospheric composition? What is the role of photochemical reactions? Are we missing key chemical or physical processes in our models?
- Is there an observable change in martian climate on the 10- to 1,000- years timescale? If so what causes it? Which processes control the evolution and stability of the residual carbon dioxide ice cap?
- How do the climate and especially the water cycle vary with orbital and obliquity variations? What is the global history of ice on Mars? How and when did the polar layered deposits form? What is the origin of the latitude-dependant ice mantle?

Future Directions for Investigations and Measurements

To address these key questions a set of investigations achievable in the next decade have been identified that relate to the atmosphere, upper atmosphere and surface volatiles. These investigations include detection and mapping possible trace gases and key isotopes, with the highest sensitivity achievable, as a window into underlying geological and possible biological activity. This will be addressed by the ESA-NASA Trace Gas Orbiter now under development. Fundamental advances in our understanding of modern climate would come from a complete determination of the three-dimensional structure of the martian atmosphere from the surface boundary layer to the exosphere. This should be performed globally, ideally by combining wind, surface pressure and accurate temperature measurements from landed and orbital payloads. Surface measurements are required to complement these measurements and to characterize the boundary layer and monitor accurately the long-term evolution of the atmospheric mass. On a global scale, a network of at least 16 meteorological stations would be ideal, and carrying capable a meteorological payload to measure surface pressure, temperature, electrical fields, and winds on all future landed missions would provide an excellent start to developing such a network. These investigations should be complemented by systematically monitoring the three-dimensional fields of water vapor, clouds, and surface frosts. Isotopic signatures of volatiles (such as HDO) should also be monitored to investigate the signature of ancient reservoirs and study fractionation processes (e.g., clouds microphysics). Finally, research and analysis should continue to improve the numerical climate modelling of the key atmospheric processes and to support laboratory research, notably in relation to the properties of carbon dioxide ice and its behaviour under martian conditions.

Characterize Mars's Ancient Climate and Climate Processes

Recent analyses of the geomorphology and surface composition of ancient terrains have confirmed that the early Mars climate system was very different and that the global environment varied throughout this early period.⁴¹ Reconstructing early martian climates remains a challenge. Whether liquid water occurred episodically or persisted over geological time scales remains debated. Solar luminosity was 25 percent lower in early martian history than today, and climate modellers have difficulty understanding how Mars's atmosphere greenhouse effect could have allowed sustained liquid water and precipitation consistent with the geological records,⁴² although volcanic greenhouse gases⁴³ or clouds⁴⁴ or impact-induced warming⁴⁵ have been suggested.

Important Questions

Some important questions concerning Mars's ancient climate and climate processes include the following:

- What was the nature of the early martian climate? Were the conditions suitable for liquid water episodic or stable on longer time scales? What processes enabled such conditions?
- How and why did the atmosphere evolve? Which process did and still do control the escape and the outgassing of the atmosphere?

Future Directions for Investigations and Measurements

Major progress in understanding the ancient martian climate can come from determining the rates of escape and outgassing of key species from the martian atmosphere, their variability and the processes at work. It will also be crucial to investigate the physical and chemical record constraining past climates

particularly the polar-layered deposits.⁴⁶ In order to follow up on scientific results and discoveries from the Phoenix and Mars Reconnaissance Orbiter missions an in situ analysis of laterally or vertically resolved measurements of grain size, dust content, composition, thickness and extent of layers, elemental and isotopic ratios relevant to age (e.g., deuterium/hydrogen) and astrobiology (CHNOPS) should be performed.

DETERMINE THE EVOLUTION OF THE SURFACE AND INTERIOR

Determining the composition, structure, and history of Mars is fundamental to understanding the planet as a whole, and provides the context for virtually every aspect of the study of conditions of habitability and the potential for the origin and persistence of life.

The specific objectives of the geology goal are to:

- Determine the nature and evolution of the geologic processes that have created and modified the martian crust over time; and
- Characterize the structure, composition, dynamics, and evolution of Mars's interior.

Subsequent sections examine each of these objectives in turn, identifies important questions to be addressed, and future investigations and measurements that could provide answers.

Determine the Nature and Evolution of the Geologic Processes that Have Created and Modified the Martian Crust over Time

The study of geologic processes will include investigating the formation and modification processes of the major geologic units, constraining the absolute ages of these processes, exploring potential hydrothermal environments, characterizing surface-atmosphere interactions, determining the tectonic history and structure of the crust, determining the present distribution of water on Mars, determining the nature and origin of crustal magnetization, and evaluating the effect of large-scale impacts. Despite our rich knowledge of martian surface properties, many questions remain about the nature of the surface and interior processes. Mars is the object in our solar system most similar to Earth, and insights into its history and evolution will inform our understanding of our planet's origin and history.

Research over the past decade has resulted in a new integrated understanding of Mars as a dynamic geologic system that has changed significantly over time.⁴⁷ In this context martian geologic history can be divided in ancient, transitional, and recent periods, with modern Mars, as observed today, providing insights into past processes and conditions.

Unlike Earth, a substantial fraction of the exposed terrain of Mars is inferred to be older than ~3.5-3.7 billion years (Noachian period). These terrains are represented by topographically high, extensively cratered surfaces that dominate the southern latitudes and provide a unique geologic record of the early stages of planet formation and possibly of the origin of prebiotic chemicals and life. Ancient Mars was marked by the presence of near-surface liquid water, with evidence for standing water, lakes, valley networks, and thick, layered sequences of sedimentary rocks with internal stratification.⁴⁸ Secondary minerals on the surface of Mars, including Fe-oxides/hydroxides/oxyhydroxides, hydrous sulfates, carbonates, phyllosilicates, and chlorides have been found by orbiters and surface missions and in martian meteorites. These minerals occur in thick, layered sedimentary units, in the soil, and in cements, veins, and rinds in individual rocks (Figure 6.5). The diversity of these mineral assemblages has been hypothesized to result from significant differences in the chemistry of the waters (brines), pH and water availability.⁴⁹ Whether or not these represent a general temporal trend⁵⁰ or more complex relationships remains uncertain (Figure 6.6).⁵¹

In situ exploration has documented mineral assemblages and aqueous processes that are more diverse and complex than seen from orbital observations. The hematite deposits discovered in Meridiani Planum from orbit⁵² were found by Opportunity to also include jarosite and other sulfates and a stratigraphic sequence inferred to indicate a sabkha-like environment that underwent wetting and drying cycles and diagenesis.⁵³ The Gusev Crater landing site has revealed complex volcanic rocks, altered materials, carbonates, Fe³⁺-hydrated sulfates in the soils, halide enrichments, and silica-rich materials thought to have formed in a hydrothermal environment.⁵⁴ The soil chemistry at the Phoenix landing site includes the presence of perchlorates and an inferred slightly basic pH⁵⁵ in contrast to the inferred acid-sulfate aqueous systems that may have dominated the wet periods in Meridiani Planum and Gusev crater.⁵⁶

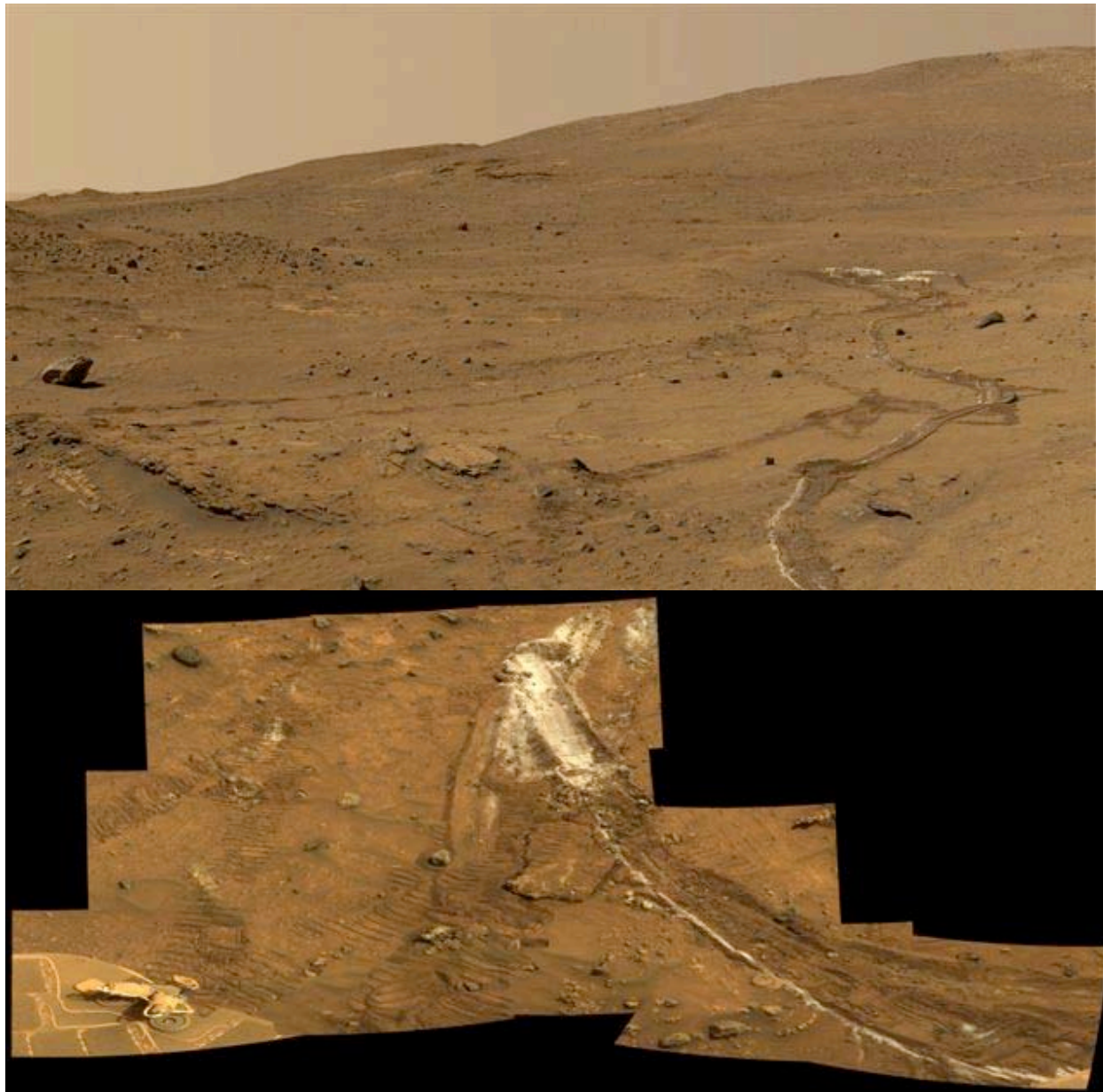

FIGURES 6.5 Examples of the mineralogic diversity recorded accessible from a surface rover mission. This image was taken by Spirit on the south side of Husband Hill. Each rover track is 10 cm wide. SOURCE: NASA/JPL.

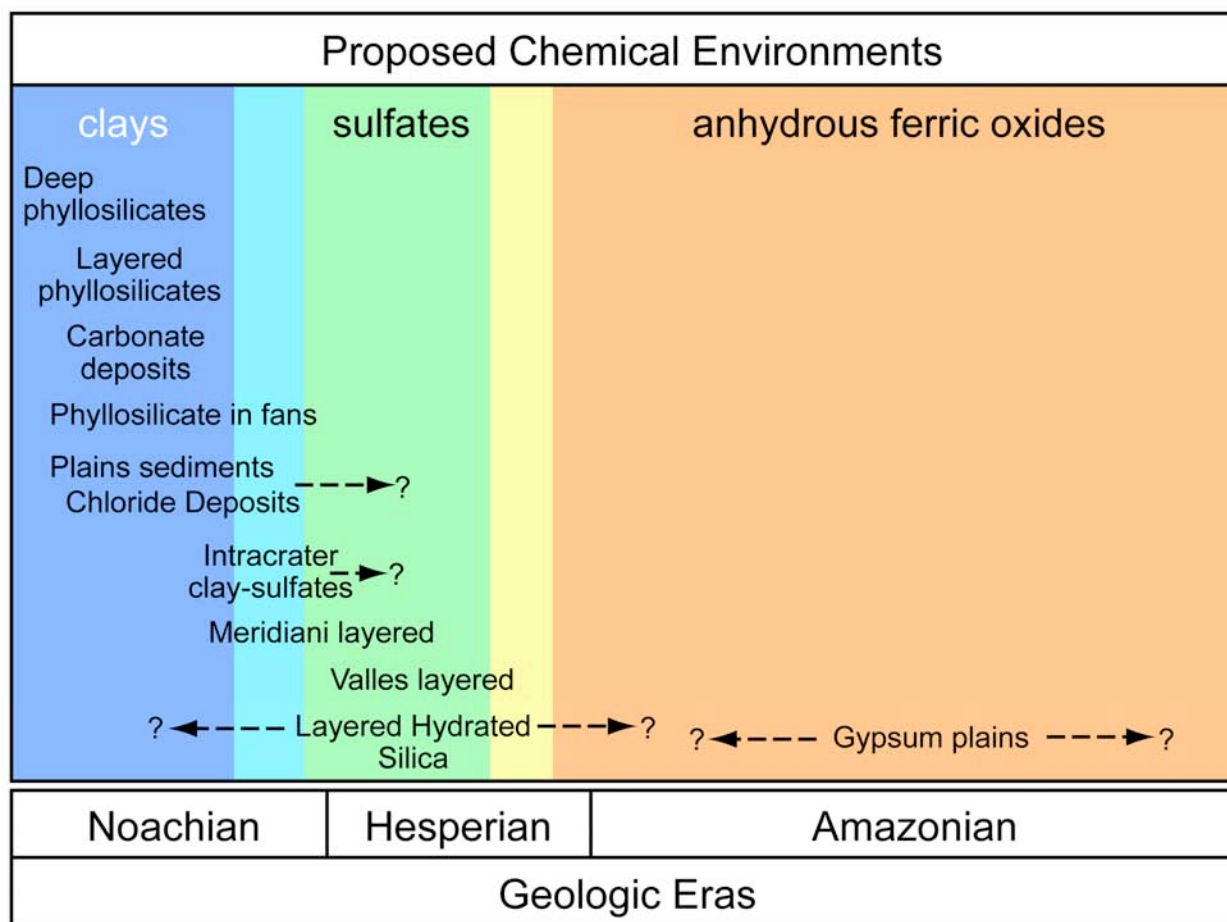

FIGURE 6.6 Geologic time sequence of events on Mars. Martian geologic eras are not well constrained in terms of absolute age. SOURCE Modified from S.L. Murchie, J.F. Mustard, B.L. Ehlmann, R.E. Milliken, J.L. Bishop, N.K. McKeown, E.Z. Noe Dobrea, F.P. Seelos, D.L. Buczowski, S.M. Wiseman, R.E. Arvidson, et al., A synthesis of martian aqueous mineralogy after one Mars year of observations from the Mars Reconnaissance Orbiter, *J. Geophys. Res.* 114:E00D06, 2009, doi: 10.1029/2009JE003342, copyright 2009 American Geophysical Union, modified by permission of American Geophysical Union.

The diversity of minerals detected from orbit has increased significantly as the spectrometers have improved dramatically in spatial and spectral resolution. A myriad of hydrated minerals have been discovered, including iron and magnesium clays, chlorite, prehnite, serpentine, kaolinite, potassium mica, opaline, analcime, and magnesium carbonate (Figure 6.2).⁵⁷ Exposures of the mineral serpentine have been identified in a variety of martian outcrops,⁵⁸ with potential significance for the formation of the reported methane as a product in alteration of olivine to serpentine. Another key discovery is the occurrence of carbonate rocks in Mars’s ancient strata using data from the CRISM aboard Mars Reconnaissance Orbiter⁵⁹ and the suite of instruments on the Spirit rover.⁶⁰ Through most of its history Mars has had very acidic surface chemistry, rarely wet and usually dry. Finding old carbonates informs us that some ancient Martian environments could have been less acid and therefore more conducive to life’s emergence.

Ancient rocks also record processes in the planet’s interior such as heat transfer from the mantle, and magnetism in the core. Radiogenic isotopes in martian meteorites and data from magnetic regions show that Mars differentiated relatively quickly (25-100 million years). Hypotheses for how the martian

dynamo formed (giant impact, degree-one convection, magma ocean cumulate overturn) have striking similarity to those proposed for the formation of the martian crustal dichotomy.⁶¹ Massive volcanic domes and escarpments (e.g., Tharsis and Elysium) indicate that large hotspots likely played a significant role in the geologic, tectonic, and thermal evolution of the planet, as well as the surface history through release of acidic volatiles to the martian atmosphere,⁶² the transport of aqueous fluids over immense distances, and the formation of hydrothermal deposits.⁶³ It is likely that the cessation of the magnetic field had a major effect on the evolution of the early martian atmosphere.⁶⁴ Thus, the history of the interior is closely connected to the atmosphere, surface mineralogy, and potential habitability, and the measurement of interior properties, identification of possible mantle phase transformations, and petrologic/geochemical studies of martian meteorites would provide crucial constraints on magmatic processes on early Mars.

Recent Mars (post ~3.0 Ga) appears to have been less active than its earlier history, with substantially reduced global aqueous modification and lowered erosion rates.⁶⁵ Radiogenic isotopes in martian basaltic meteorites show that the products of early differentiation may have remained isolated for most of the history of Mars. The young ages of martian meteorites have placed constraints on both the igneous history of the planet and also dynamic models for material transport from Mars to Earth. Orbital observations show clues for volcanic activity in the last hundred million years.

Secondary minerals in martian meteorites show a range of ages from 3.9-billion to 100-million years old, suggesting that fluids were present in the martian crust for most of Mars's history.⁶⁶ Secondary minerals in martian meteorites also record isotopic signatures indicating interaction with the martian atmosphere, and impact glasses have trapped martian atmosphere and possibly regolith material.

We now have global maps of topography,⁶⁷ mineral distribution,⁶⁸ and morphology at scales of 6-18 m,⁶⁹ with local topography and texture at scales of <1 m.⁷⁰ Maps of gravity and magnetic fields show a thicker crust with isostatic compensation in the south and uncompensated gravity anomalies in the north.⁷¹ Orbital data have revealed active or recent processes of impacts, landslides, gully formation, wind, the formation of widespread mid-latitude ice deposits, and changing carbon dioxide ice cover. The reported methane in Mars's atmosphere may be related to active near-surface processes. In the polar regions, layered deposits dominated by ice and sedimentary deposits likely record geologically recent climate change. These results have significantly expanded the known water inventory and demonstrated that the surface and near surface is an active, changing environment, with water, particularly in the form of ice, apparently redistributed by climate changes on timescales of 10's to 100's of thousand years.

Important Questions

Some important questions concerning the nature and evolution of the geologic processes that have created and modified the martian crust over time include the following:

- How, when, and why did environments vary through Mars's history and were these environments habitable? What was the origin and nature of the diverse sedimentary units and inferred aqueous environments, what are their ages, and how did significant accumulations of layered sediments form? What is the mineralogy of the regolith and how did it form?
 - Are reduced carbon compounds preserved and, if so, in what geologic environments? What is the origin of the reported methane? What is the martian carbon cycle?
 - What is the petrogenesis and character of the igneous rocks, how old are they, and what does this tell us about martian crustal and mantle processes and formation of the core? How do martian meteorites relate to the martian surface?
 - What is the geologic record of climate change? How do the polar layered deposits and layered sedimentary rocks record the present-day and past climate and the volcanic and orbital history of Mars?

Future Directions for Investigations and Measurements

Key investigations to advance our understanding of geologic processes that have governed Mars's evolution include understanding the origin and nature of the sedimentary units by applying physical and geochemical models, remote and in situ observations of diverse suites of sedimentary materials on Mars, and laboratory investigations of Mars analog materials to study the formation, transport, and deposition of sedimentary materials by fluvial, Aeolian, impact, and mass wasting processes. Major advances will come from the investigation of the petrologic, mineralogic, isotopic, geochronologic properties of rock suites in returned martian samples, martian meteorites, and Mars analog materials in order to understand environmental conditions and habitability over time, the history and timing of core separation and differentiation, past tectonic processes, Mars's past and present geophysical properties, the bulk, mantle and core compositions, and the relationship between martian meteorites and igneous rocks on Mars's surface. Key investigations are needed to explore the distribution and source of reduced carbon compounds in the surface and atmosphere. Better characterization of the distribution of carbon dioxide and water on a long-term scale and more detailed examination the polar layered deposits and layered sedimentary rocks for the record of the present-day and past climate will both help to better understand volatile budgets and cycles.

Refined criteria need to be developed for selecting sample suites for return to Earth, including sample suites for sensitive analysis of biomarkers (e.g., CHNOPS elements), suites representing diverse sedimentary environments with possible rapid burial, suites showing chemical gradients formed through alteration, oxidation, neutralization and precipitation, and those from aqueous alteration environments including hydrothermal suites that show potential for preserving biosignatures; igneous suites; regolith samples, and atmospheric. Finally we need advances in technologies to better collect, handle, curate, analyze, and study martian materials, meteorites and analog samples on all scales in a range of environmental conditions, and in the context of new experimental and theoretical data, and planetary protection guidelines.

Characterize the Structure, Composition, Dynamics, and Evolution of Mars's Interior

The interior of Mars will be investigated by characterizing the structure and dynamics of the interior, determining the origin and history of the magnetic field, and determining the chemical and thermal evolution of the planet. Unfortunately, there has been little progress made toward a better understanding of the martian interior and the processes that have occurred. Probing the interior is best done through a network of geophysical stations, and such a network has not yet been implemented at Mars.

Important Questions

Some important questions concerning the structure, composition, dynamics, and evolution of Mars's interior include the following:

- What is the interior structure of Mars? How are core separation and differentiation processes related to the initiation and/or failure of plate tectonic processes on Mars?
- When did these major interior events occur, and how did they affect the magnetic field and internal structure? What is the history of the martian dynamo? What were the major heat flow mechanisms that operated on Early Mars?
- What is Mars's tectonic, seismic, and volcanic activity today? How, when, and why did the crustal dichotomy form? What is the present lithospheric structure? What are the martian bulk, mantle

and core compositions? How has Mars's internal structure affected its magmatism, atmosphere, and habitability?

Future Directions for Investigations and Measurements

Major progress in understanding Mars's interior requires obtaining key geophysical data through a network.⁷² Seismic data will enhance understanding of the martian interior structure, including present lithosphere/crust structure and thickness, the current seismic and volcanic activity, the depth of crustal magnetization, the basal structures of the crust under large topographic highs (e.g., Tharsis and Elysium) and lows (e.g., Hellas Basin), and place boundary conditions on models of the early thermal profiles, heat flows and geologic evolution. Also we need to acquire other geophysical data (e.g., heat flow and magnetic sounding) to better constrain the mineralogical, density and temperature structure of the martian interior.

INTERCONNECTIONS

To Earth and the Terrestrial Planets

Mars is unique in solar system exploration because it has had processes comparable to Earth during its formation, interior evolution, surface modification, geochemical alteration, and atmospheric and climate evolution. Crucially, and perhaps uniquely, the martian surface preserves a record of the early solar system history on a planet with water and an atmosphere in which the conditions may have been similar to those on Earth when life originated. This record has been obliterated on Earth during crustal recycling related to plate tectonics. Mars records critical information that can provide a means to approach (and possibly answer) questions about the environmental conditions that may have accompanied the origin and evolution of life, short and long-term climate change, in comparison to Earth, and the early evolution and origin of the terrestrial planets.

When and how life began on Earth is not yet known. Evidence for early life on Earth has been reported in rocks at least as old as 3.7 billion years.⁷³ The general processes by which the inventory of the basic building blocks of life was assembled, how those pre-biotic components were chemically reorganized, and how replicating life forms originated and evolved all took place during the critical time period before 3.5 Ga. However, for the first billion years of Earth's history, our ability to read the geologic record is either fragmentary or non-existent. Mars has a number of characteristics that make it the most probable location for pre-biotic processes to have occurred and for that record to be preserved. Mars is in the "habitable zone" around our host star, it likely had liquid water at some points in the past, and it might have had a thicker atmosphere that protected the prebiotic and biotic material from radiation. Mars today contains the essential ingredients to support and sustain life, and the geologic record shows numerous promising ancient habitable environments.⁷⁴

The martian atmosphere is a simpler system than Earth, but it is also the most Earth-like of all the planetary atmospheres. This provides the opportunity to validate climate and atmospheric circulation models and to test these models of physical systems with different boundary conditions. Mars's atmosphere has evolved significantly with time. It shows clear evidence for periodic climate change, which, combined with calculations of the effects of large excursions in orbital parameters, all point to significant changes in insolation driving major redistributions of water over the planet in cyclic episodes that are analogous to Earth's ice ages.

The inferred origins and evolution of the four terrestrial planets are as varied as their surfaces and current environments. Mars is unique in the accessibility and comparative hospitability of its surface relative to Venus and Mercury. Its level of historical thermal and geological activity, intermediate between Earth and the Moon, is ideally suitable both for elucidating the initial conditions of the terrestrial

planets and for understanding subsequent processes such as accretion, magma oceans, differentiation, core convection, dynamo generation, partial melting and volcanism. Mars, the Moon, Venus, and Mercury are linked by similar bombardment histories, and all contain evidence for volcanism, differentiation and early crustal growth. Of these inner planets, Mars has evidence of an early dynamo process, absent on Venus and the Moon. Thus, Mars provides information on the early stages of planet formation and heat-loss mechanisms that are crucial for putting the differentiation history, bulk chemistry and geophysical properties of all of the inner planets, including Earth, in context.

To Extrasolar Planets

Mars provides a unique alternative to Earth as a leading potential example of a planet that has been habitable in the past, at least episodically. Therefore, it is especially interesting with regard to our understanding of the habitability of extrasolar terrestrial planets and the likeliness of life elsewhere. In particular:

- Mars has a low mass/radius relative to Earth and therefore expands the possible range of silicate extrasolar planet mass/radius values that may be targeted for habitability;
- The potential discovery of habitable regions on Mars forces us to expand the concept of the classic “habitable zone”⁷⁵ within planetary systems;
- Ancient Mars was probably a case of a relatively dry planet (no global oceans) with an environmental regime fundamentally different than that of our planet, and which we can study through the geological records; and
- The fact that Mars has lost its ability to sustain liquid water teaches us lessons about possible processes that may prevent many extrasolar planets from remaining habitable.

To Human Exploration

Mars is the only planet in the solar system that is realistically accessible to human exploration, and has been proposed as a target for orbital flybys and future landing by human explorers. To reduce the cost and risk for future human exploration, robotic precursor missions would be needed to acquire information concerning potential resources and hazards, perform technology and flight system demonstrations, and deploy infrastructure to support future human exploration activities. The elements of the Mars Sample Return campaign, beginning with MSL, will provide crucial data for landing significant mass, executing surface ascent and return to Earth, and identifying potential hazards and resources.⁷⁶

IMPORTANCE OF MARS SAMPLE RETURN

For the past three decades, the scientific community has consistently advocated the return of geological samples from Mars. Summaries of the literature on this topic appear in the extensive writings of the NRC,⁷⁷ several major recent reports by MEPAG,⁷⁸ and a significant recent contribution by the International Mars Exploration Working Group.⁷⁹ Numerous white papers submitted to the NRC Decadal Survey indicated substantial community support via signatories and addressed the importance and significance of Mars Sample Return as the keystone of future Mars exploration.⁸⁰

The committee, building on numerous community assessment groups, open discussions, and white papers, places as the highest priority Mars science goal to address in detail the questions of habitability and the potential origin and evolution of life on Mars. The committee carefully considered the alternative of several rover missions instead of sample return. It is our opinion that sample return would have significantly higher science return and a much higher science-to-dollar ratio. Thus, a critical

next step toward answering these questions would be provided through the analysis of carefully selected samples from geologically diverse and well-characterized sites that are returned to Earth for detailed study. Existing scientific knowledge of Mars makes it possible to select a site from which to collect an excellent suite of rock and soil samples to address the life and habitability questions, and the technology to implement the sample return campaign exists, or will be developed—including required entry, descent, and landing and rover mobility systems. Existing and future analysis techniques developed in laboratories around the world will provide the means to perform a wide array of tests on these samples, develop hypotheses for the origin of their chemical, isotopic, and morphologic signatures, and, most importantly, perform follow-up measurements to test and validate the findings.

BOX 6.3 Sample Return is the Next Step

The analysis of carefully selected and well documented samples from a well characterized site will provide the highest scientific return on investment for understanding Mars in the context of solar system evolution and addressing the question of whether Mars has ever been an abode of life.

The purpose and context of a Mars sample return has changed significantly since the early concepts that focused solely on reconnaissance. At that time the key questions centered on bulk planetary geochemistry, petrology, and geochronology, for which a wide range of sample types would be acceptable. Today the emphasis is on well characterized and carefully selected rocks, with the recognition of the critical importance of sedimentary rocks that provide clues to aqueous and environmental conditions. While it is widely accepted that we have samples of Mars on Earth in the form of the SNC meteorites, they are not representative of the diversity of Mars. They are all igneous in origin, whereas recent observations have shown the occurrence of chemical sedimentary rocks of aqueous origin as well as igneous, metamorphic, and sedimentary rocks that have been aqueously altered. It is these aqueous and altered materials that will provide the opportunity to study aqueous environments and potential prebiotic chemistry.

Two approaches exist to study martian materials – *in situ* measurements or through returned samples. Returning samples allows for the analysis of elemental, mineralogic, petrologic, isotopic, and textural information using state-of-the-art instrumentation in multiple laboratories. In addition, it allows for the application of different analytical approaches using technologies that advance over a decade or more, and, most importantly, the opportunity to conduct follow-up experiments that are essential to validate and corroborate the results. On an *in situ* mission, only an extremely limited set of experiments can be performed because of the difficulty of miniaturizing state-of-the-art analytical tools within the limited payload capacity of a lander or rover. In addition, these discrete experiments must be selected years in advance of the mission's launch. Finally, calibrating and validating the results of sophisticated experiments can be challenging in a lab, and will be significantly more difficult when done remotely. The Viking and the ALH84001 martian meteorite experiences underscore the differences in these approaches. It has proven difficult to reach unique conclusions regarding the existence of possible extant life or organic materials from the Viking data because of the assumptions regarding the nature of the martian surface materials that were necessary to design the instrument payload. For example, recent analysis of the Phoenix data suggest that oxidizing compounds may have been present that would have destroyed any organics during the sample heating required for the Viking instruments, raising significant questions about the interpretation of the Viking results. In contrast, the ALH84001 experience underscores the tremendous value of being able to perform a large number of independent analyses and follow-on experiments. Multiple approaches in numerous laboratories have been possible over a decade because the samples were on Earth, and new experiments could be performed to test differing hypotheses. One essential lesson from ALH84001 is how involved sample studies can be, requiring multiple methods, complex sample preparation, and the collective capability of Earth's research laboratories to evaluate complex questions. Finally, searching for evidence of extant life at Mars with a limited suite of

experiments, compounded by the uncertainty regarding the nature of possible martian life and issues of terrestrial contamination, would be difficult and carries very high scientific risk.

Discoveries by MSL could provide additional justification for sample return, but are unlikely to alter the basic architecture of sample return, in which the primary system variables—the sample site and the samples that are collected—are not constrained in the proposed architecture. Similarly, the lack of major new discoveries by MSL would not impact the importance of getting samples back to Earth, and may well increase the importance of collecting and studying samples in terrestrial labs where a much broader suite of measurements could be obtained.

Experience based on previous studies (e.g., of meteorites, the Moon, cometary dust, and the solar wind) strongly supports the importance of sample analysis. Such a diversity of techniques, analysis over time, improvements in sensitivity, and new approaches available in terrestrial labs are expected to revolutionize our understanding of Mars in ways that simply cannot be done in situ or by remote sensing.^{81,82}

Site Selection and Context

The information needed to select a sample return site that would address high-priority science objectives has been, or can be, acquired with current assets.

Mars is a remarkably diverse planet with a wide range of aqueous environments preserved in its rock record. As a result of two decades of orbital and in situ exploration of Mars, a large number of excellent candidate sample return sites, where water played a major role in the surface evolution, have already been identified. Significantly, the geologic setting of these sites—as identified through mineralogic and stratigraphic mapping—indicate that there were major differences in water chemistry and temperature, weathering processes, and sediment transport and deposition processes across Mars, providing a diversity of environments from which to collect samples. The known sites also contain diverse sedimentary and igneous terrains within the roving range of existing spacecraft.

The site will be selected on the basis of compelling evidence in the orbital data for aqueous processes and a geologic context for the environment (e.g., fluvial, lacustrine, or hydrothermal). The sample collection rover must have the necessary mobility and in situ capability to collect a diverse suite of samples based on stratigraphy, mineralogy, composition, and texture.⁸³ Some biosignature detection, such as a first-order identification of carbon compounds, should be included, but it does not need to be highly sophisticated, because the samples will be studied in detail on Earth.⁸⁴

Sample Criteria

Selecting and preserving high quality samples is essential to the success of the sample return effort. MEPAG identified 11 scientific objectives for Mars sample return (MSR) and specified the minimum criteria for the sample to meet these objectives.⁸⁵ The collection of Mars samples will be most valuable if they are collected as sample suites chosen to represent the diverse products of various planetary processes (particularly aqueous processes), and addressing the scientific objectives for MSR will require multiple sample suites. A full program of science investigations is expected to require samples of ≥ 8 g for bedrock, loose rocks and finer-grained regolith and 2 g. to support biohazard testing, each for an optimal size of 10 g.⁸⁶ Textural studies of some rock types might require one or more larger samples of ~ 20 g. The number of samples needed to address the MSR scientific objectives effectively is 35 (28 rock, 4 regolith, 1 dust, 2 gas). In order to retain scientific value, returned samples must be fully isolated and sealed from the martian atmosphere, each sample must be linked uniquely to its documented field context, and rocks should be protected against fragmentation during transport. The encapsulation of at least some samples must retain any released volatile components.⁸⁷

Technical Implementation and Feasibility

A three-element, step-by-step sample return campaign would reduce scientific, technical and cost risks. It builds on technologies developed over the last decade of Mars exploration, though major technical challenges remain that must be addressed in a technology development effort that would be an integral part of the sample return campaign.

The proposed strategy would conduct sample return as a campaign with three separate steps:

1. A caching rover, the Mars Astrobiology Explorer-Cacher (MAX-C), followed by;
2. A sample return lander (MSR-L) that would include a rover to fetch the sample cache and an ascent vehicle to loft it into orbit for
3. Rendezvous and return by a sample return orbiter (MSR-O).

This campaign would be scientifically robust, with the flexibility to return to a previously visited site (e.g., if motivated by an MSL discovery), go to a new site, or fly a second MAX-C rover if the first mission was unsuccessful for any reason. It would also be technically and programmatically robust, with a modular approach and multiple caches left on the surface by MAX-C to recover from a failure of either the MSR-L or –O elements without requiring a reflight of MAX-C.

The Mars Exploration Program has made significant strides in developing the technologies needed for this multi-element sample return scenario. In particular:

- Mars Pathfinder and the Mars Exploration Rovers (MER) have demonstrated surface mobility, and MER has demonstrated much of the basic instrumentation needed to select high-priority samples.
- MER and Phoenix have provided valuable experience in sample handling and surface preparations; MSL will go significantly further.
- The MSL Sky Crane entry, descent, and landing system design will support Mars sample return. It can deploy a caching rover and can accommodate the MSR-L with a fetch rover and Mars Ascent Vehicle.
- Technologies that can be adapted to orbital rendezvous and sample canister capture have been demonstrated in Earth orbit.
- Sample-return protocols and Earth-return entry encapsulation have been validated by the Stardust and Genesis missions.

Critical technologies still need to be developed.⁸⁸ These include sample collection and handling, the Mars Ascent Vehicle (MAV), orbital acquisition, and back planetary protection. The MAV, in particular, is a system with significant development risk, pointing to the need for an early start to perform trade studies, retire technology risks, and develop and flight-test a flight-like engineering unit in a relevant environment. Key technology elements for the MSR-O include autonomously actuated mechanisms for orbital capture; optical sensors; orbital radio beacon; autonomous rendezvous guidance, navigation and control; and ground validation tests.

SUPPORTING RESEARCH AND RELATED ACTIVITIES

Sample Handling Facilities

Perhaps the largest driving force for planning and funding is return of martian samples. Planning should begin on the requirements and needs for this facility to curate and analyze these unique samples and preserve them in a Mars-like environment to prevent alteration.

PREPUBLICATION COPY—SUBJECT TO FURTHER EDITORIAL CORRECTION

Curation

Martian samples require screening for evidence of life and for biohazards, possibly necessitating robotic handling, temperature and atmosphere control, and strict biological isolation. They will also require special procedures beyond those in typical biosafety facilities. For example, most biosafety facilities maintain negative pressure, driving outside air into the facility, and only controlling the air exiting the facility. In the case of Mars samples the outside air must also be carefully controlled to prevent contamination. No existing sample handling facility currently meets the biosafety and environmental controls required for martian samples.

Sample Analysis

The possibility of detecting life in martian samples and the attendant risk of terrestrial contamination require the preparation of extensive new analysis facilities, which will require a major planning and implementation process. Instruments will need to be sterile and isolated. Some instruments may also need environmental controls, particularly including temperature, and monitoring for gas release. Major instrumentation may need to include mass spectrometers, and electron microscopes, and microprobes. Significant planning is required, along with updates to the NRC's 2002 report, *The Quarantine and Certification of Martian Samples*, with specific attention to facility and handling recommendations.

TECHNOLOGY DEVELOPMENT

As Mars exploration moves toward sample return, surface networks, and sophisticated in situ analysis, it will require a suite of technology development efforts, primarily focused in the areas of sample acquisition and handling, Mars ascent, and orbital rendezvous. Improvements in instrumentation, ground-based infrastructure and data analysis are also critical to the long-term success of the Mars exploration program. The highest priority recommendations for the coming decade for Mars sample return are, sample acquisition and processing technology funding to support the MAX-C mission, and sufficient technology development funding for the Mars Ascent Vehicle (MAV). Future technology development should focus on the Earth Entry Vehicle and sample containment. No technology development is required for the 2016 Trace Gas Orbiter mission. MAX-C will rely heavily on existing entry, descent, and landing technology and derivatives of existing remote-sensing and contact instrumentation. The necessary investments in technology for MAX-C should focus on the continued development of tools to effectively acquire and cache samples and on development and demonstration of high technology readiness level sample selection instruments. (See Table 6.2)

The Mars Ascent Vehicle (MAV), as part of the MSR-L element is the greatest technology challenge for this decadal period. It must survive both the landing shock and the martian surface thermal environment. The risk of mass and cost growth must be mitigated through an early test program because of its currently low TRL. Technology development for this element of the MSR-L mission (which is under consideration for the following decade) should begin in this decade.

The MAX-C rover may require improvement in the entry, descent and landing precision—landing ellipse semi-major axis reduction from 10 kilometers to 6-7 kilometers can be accomplished with more accurate inertial measurement unit handover at separation, and the use of range, rather than velocity, trigger for deployment of the parachute. A straightforward approach to contain and efficiently transfer the samples from the sample acquisition device to the storage medium and its effective sealing for planetary protection must be developed. The rover may require improvement in the on-board operations avionics to enable faster traverse mobility, in addition to automating target approach, measurement, and sample acquisition. If required, this technology development should begin immediately.

The MSR-O element (which is under consideration for the following decade) and includes the flight of the Earth entry vehicle requires development of optical sensors, autonomous rendezvous guidance and radio beacons for rendezvous with the orbiting sample container. Technology development for the MSR-Orbiter would need to begin in FY17 to support an FY22 launch. All of the component technologies for the Earth-entry vehicle are available today, including the carbon phenolic heat shield material that meets the planetary protection requirements. However, the Earth-entry vehicle requires a rigorous ground-based test program and a systems validation flight test to ensure sufficiently high reliability. This technology development would need to begin in FY15 to support an FY22 launch.

INSTRUMENTATION AND INFRASTRUCTURE

Science instruments for future missions will require increased funding beyond that provided by current levels of programs to mature instrumentation to TRL 6. In addition to the near-term development of miniaturized instruments, such as Raman, infrared, and elemental spectrometers, needed for selection of samples for caching by MAX-C, and the long-term development of instruments for follow-on in situ science should be supported, focusing on the most important future in situ measurements. Examples include isotopic characterization of a variety of biomarkers, identification of organic materials indicative of current or past biological systems, sensitive life detection experiments, analysis of metastable minerals and organic compounds, and in situ geochronology experiments.

Mars Telecommunications

Addition of a relay payload with standardized protocols to each science orbiter provides an extremely cost-effective means for establishing a Mars orbiter relay network. Maintaining redundant relay assets whenever relay services are required is a goal, and the key to achieving this goal is attaining a long operational lifetime for each orbital relay asset. NASA's Deep Space Network remains a critical part of the Mars exploration infrastructure. Continued development of on-board data processing methods can alleviate mission bandwidth constraints for near term missions. In the longer term both orbital and landed missions will greatly benefit from optical communication technologies.

Sample Curation and Laboratory Facilities

Sample return missions are unique in that they require a well-developed infrastructure and capabilities for the appropriate curation and analyses of the returned materials. Dedicated curation laboratories must be designed and constructed before samples are returned. Special requirements for long-term preservation of ices, atmospheric samples, volatiles, and metastable materials are required, as are screening for life and biohazards in a dedicated sample receiving facility. There is need for continued development of advanced sample processing and preparation techniques. The recommendations of the NRC's 2002 report *The Quarantine and Certification of Martian Samples* may need to be examined and updated as necessary based on the current plans for the nature and quantity of the returned sample.

Supporting Laboratory and Theoretical Studies

Relevant laboratory studies have in the past been deferred, due largely to their expense, but are essential to support sample return. The development and maintenance of spectral reference libraries for atmospheric and surface composition studies, in ultraviolet, visible, infrared, and microwave spectral ranges need to be undertaken. Materials must be measured at the appropriate temperatures, pressures,

particle sizes, wavelength ranges, and viewing geometries for applicability to spacecraft observations of the martian surface and atmosphere. Theoretical model developments must also proceed to be able to link quantitatively flight and laboratory-based data sets. Laboratory studies are also needed that help determine the survival of organics under martian surface conditions. Support is required for basic laboratory research with potential in situ instrument development even at laboratory scale. Increased collaboration with the National Science Foundation, National Institutes of Health and other institutions addressing similar scientific and technological challenges related to microbial life at low temperatures will enhance this work.

Earth-Based Observations

Earth-based telescopic observations have been important for understanding the current and past conditions for the martian atmosphere and surface. For example, the reported detection of methane in the atmosphere has been a critical factor that has helped shape the plans for new orbital measurements. These observation types should continue and evolve to support spacecraft observations.

ADVANCING STUDIES OF MARS: 2013-2022

Previously Recommended Missions

The 2003 planetary science decadal survey recommended five Mars missions—technology development to enable Mars sample return, the Mars Science Laboratory, a long-lived lander network, an upper atmosphere orbiter, and the Mars Scout program. Of these five recommended missions, three have flown or are in final development. The upper atmosphere mission is being implemented as the Mars Scout MAVEN mission, with a planned 2013 launch. The MSL mission is planned to launch in 2011 and the Mars Scout program has produced both the Phoenix lander (2008) and MAVEN. MSL, which was described only in very general terms in the 2003 report, grew significantly in capability beyond what the 2003 survey envisioned, and will achieve significantly more science than originally planned. The PI-led Scout program has been incorporated into the Discovery program.

New Mission

Mars Sample Return Campaign

The committee places as the highest priority Mars science goal to address in detail the questions of habitability and the potential origin and evolution of life on Mars. A critical next step toward answering these questions will be provided through the analysis of carefully selected samples from geologically diverse and well-characterized sites that are returned to Earth for detailed study using a wide diversity of laboratory techniques. Therefore, the highest priority missions for Mars in the coming decade are the elements of the Mars sample return campaign—the Mars Astrobiology Explorer-Cacher (MAX-C) to collect and cache samples, followed by the Mars Sample Return Lander (MSR-L) and the Mars Sample Return Orbiter (MSR-O) to retrieve these samples and return them to Earth, where they will be analyzed in the Mars returned sample handling facility (MRSF) (Figure 6.7).

MAX-C is the critical first element of Mars sample return and should be viewed primarily in the context of sample return, rather than as a separate mission that is independent of the sample return objective. The MAX-C mission, by design, focuses on the collection and caching of samples from a site with the highest potential to study aqueous environments, potential prebiotic chemistry, and habitability. In order to minimize cost and focus the technology development, the mission emphasizes the sample

system and deemphasizes the use of *in situ* science experiments. This design approach naturally leads to a mission that has a lower science value if sample return does not occur. However, exploring a new site on a diverse planet with a science payload similar in capability to that of the MER rovers will significantly advance our understanding of the geologic history and evolution of Mars, even before the cached samples are returned to Earth.

By implementing sample return as a sequence of three missions, the highest-priority Mars objective of advancing the search for evidence of life on Mars can be achieved at a pace that maintains solar system balance and fits within the available funding. The architecture provides resilience to adapt to budgetary changes and robustness against mission failures. Two caches will be collected and remain scientifically viable for up to 20 years on the surface or in orbit about Mars so that a failure of the MAV would not necessitate reflight of MAX-C and neither the MAV nor MAX-C would need to be reflown if the return orbiter failed to achieve orbit. A modular approach also permits timely reaction to scientific discoveries, in which a follow-on rover mission could pursue a major new finding, and it enables additional Mars sample return missions using these same flight elements.

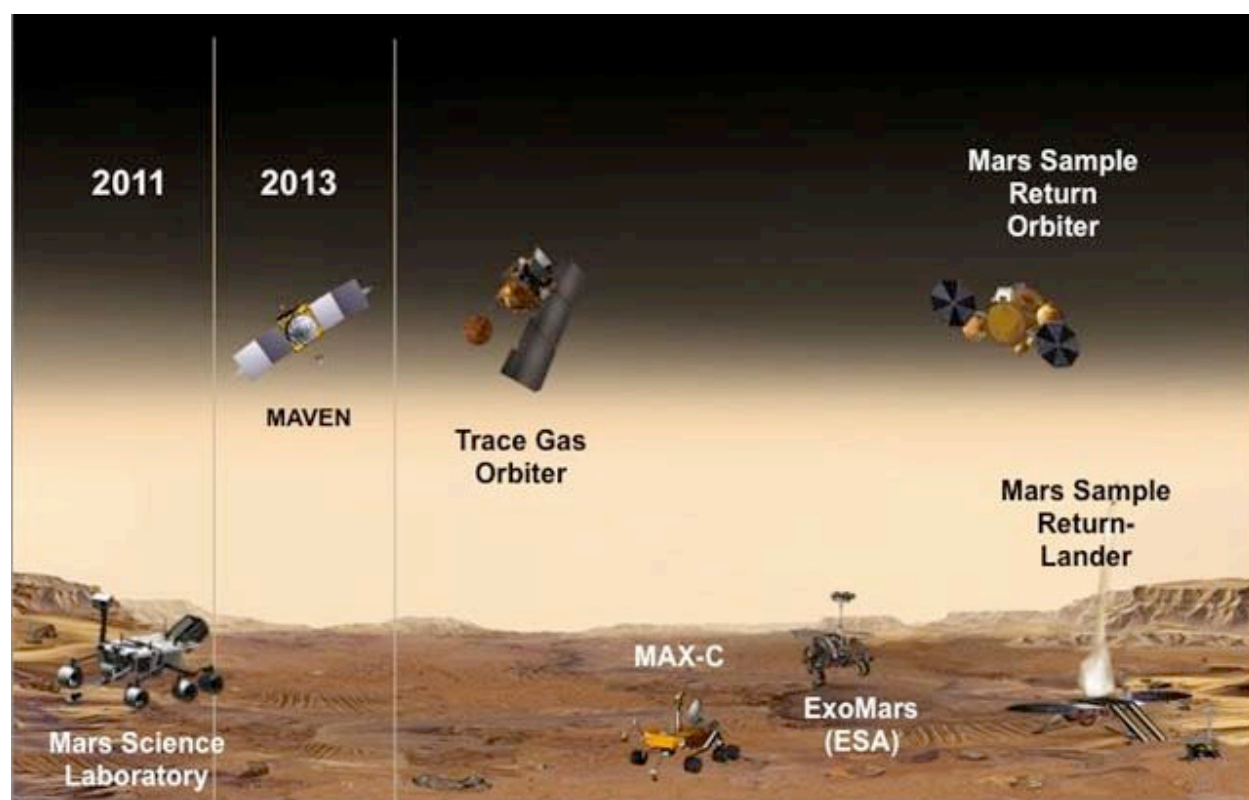

FIGURE 6.7 Mars Sample Return architecture. SOURCE: NASA Planetary Science Division.

Mars Astrobiology Explorer-Cacher

MAX-C, the sample collection rover would be landed using a duplicate of the Sky Crane entry, descent, and landing (EDL) system. The baseline design is a MER-class (~350 kg), solar-powered rover with ~20 km of mobility over a 500-sol mission lifetime. It will carry ~35 kg of payload for sample collection, handling, and caching, and a MER-class (~25 kg) suite of mast- and arm-mounted remote sensing and contact instruments to select the samples. The key new development will be the sample coring, collection, and caching system. MAX-C will acquire ~20 primary and ~20 contingency rock cores, each 10 gm in mass, from rock targets with a high likelihood of preserving evidence for past

environmental conditions including habitability, and the possibility of preserved biosignatures. These cores will be sealed in two separate caches for redundancy and left on the surface for retrieval by a subsequent mission. The cache systems will be designed to prevent cross contamination between samples, prevent exposure to the martian atmosphere, keep the samples within the temperature range that they experienced prior to collection, and preserve the samples in this condition for up to 20 years.

Mars Sample Return Lander

The MSR-L will also land using the Sky Crane system, and will carry a fetch rover, local regolith and atmosphere sample collection system, and the Mars ascent vehicle (MAV). The fetch rover will be capable of reaching the cache from any point within the 11-km radius landing error ellipse within three months. The strawman MAV design is a solid rocket that is maintained in a thermally controlled cocoon while on the martian surface for up to 1 Earth year. Following sample retrieval, the lander will place the cache in the orbital sample (OS) container, collect regolith and atmospheric samples, and seal the container to meet the planetary protection requirements. The MAV will insert the OS into a stable 500-km altitude near-circular orbit.

Mars Sample Return Orbiter

The MSR-O will consist of a Mars orbiter, the orbital sample acquisition and capture system, the sample isolation system for planetary protection, and the Earth-entry vehicle. The orbiter will detect, track, and rendezvous with the OS, then capture and seal it in the Earth entry vehicle. The orbiter will leave Mars and release the entry vehicle to Earth, where it will enter Earth's atmosphere and hard land using a parachute-less, self-righting system.

Mars Returned Sample Handling Facility

The Mars returned sample-handling element will meet the planetary protection requirements and will be based on practices and procedures at existing biocontainment laboratories, the NASA's Lunar Sample Facility, and pharmaceutical laboratories.

Trace Gas Orbiter

The Trace Gas Orbiter (TGO) is currently conceived as a joint ESA-NASA collaboration to study the temporal and spatial distribution of trace gases, atmospheric state, and surface-atmosphere interactions on Mars. This mission builds upon the reported discovery of methane in the martian atmosphere.⁸⁹ The committee could only evaluate the science return of this mission in a general sense, because the payload had not been selected as of the time of the evaluation. In addition, no independent cost estimate for this mission was generated because it would have been inappropriate to perform such a science and cost evaluation during the competitive instrument payload selection that was underway at the time of this assessment. NASA-provided cost estimates were used instead.

Technology Development

One of the highest priority activities for the upcoming decade will be to develop the technologies necessary to return samples from Mars. The technology program also needs to continue a robust instrument development program so that future in situ missions can include the most advanced technologies possible. The new developments needed for MAX-C are the sample coring, collection, and caching system. The modest technology development for these systems have begun and should be continued at a the level necessary to develop them to TRL 6 at the time the mission is approved.

The major new sample-return technology needed will be the MAV. While this launch system will be based on existing solid rocket motor designs, major development will be needed in thermal control, autonomous launch operations, and ascent and guidance under martian conditions. It is essential that these elements receive major investments during the coming decade in order to assure that they will reach the necessary maturity to be used by the end of the coming decade or early in the next.

The second major technology development that will require attention is the tracking, rendezvous, and capture of the OS. An initial demonstration of this technology has been performed by the Defense Advanced Research Projects Agency's Orbital Express mission, which performed detection and rendezvous in Earth orbit under similar conditions. The MSR capture-basket concept has been demonstrated on zero-g aircraft flights. However, significant technology development will still be required to develop this system for application at Mars.

The third technology element development is the planetary protection component of MSR to ensure that the back contamination (contamination of Earth by martian materials) requirements are met. This system will require isolating the Mars sample cache completely and reliably throughout the entry, retrieval, and transport process. This work will require the development and testing of the technology elements, and the development of methods and procedures to verify the required level of cleanliness in flight.

Finally, the definition and architecture development of the Mars return sample-handling facility needs to be accomplished in the coming decade. Significant issues must be resolved and requirements defined regarding the methods, procedures, and equipment that can verify the required level of isolation and planetary protection and sample characterization.

New Frontiers Missions

Mars Geophysical Network

A high priority Mars science goals can be addressed by a New Frontiers-class geophysical network. The prioritized science objectives for a Mars Geophysical Network mission are as follows:

1. Measure crustal structure and thickness, and core size, density, and structure, and investigate mantle compositional structure and phase transitions.
2. Characterize the local meteorology and provide ground truth for orbital climate measurements.

A study of the Mars Geophysical Network was performed at the committee's request (Appendices D and G). Two identical free-flying vehicles would be launched on a single Atlas V 401 independently targeted for Mars entry 7 days apart, and land at sites geographically distributed to meet the science objectives. Each node of the network will carry a three-axis very broad band seismometer with a shield and a X-band transponder, an atmospheric package with pressure sensor, thermistors, and hotwire anemometer, a deployment arm, descent and post-landing cameras, and a radio science package.

The science payload would have a 1 martian year nominal mission with continuous operation. This instrumentation would allow the determination of crustal and lithosphere structure by cross-correlation of the atmospherically induced seismic noise and would locate the seismic sources from joint travel times and azimuth determinations. No major new technologies are required. The selected entry, descent, and landing architecture for this study employs a powered descent lander with heritage from previous Mars missions. Key technology development for the seismometer has been conducted over the past two decades, culminating in a TRL 5–6 instrument developed for the ESA ExoMars mission.

Mars Polar Climate Mission

As a follow on to Phoenix, the next step for in situ high-latitude ice studies is to explore the exposed polar layered deposits (PLD). A mission study initiated at the committee's request (see Appendices D and G) addressed science objectives include understanding the mechanism of climate change on Mars and how it relates to climate change on Earth, to determine the chronology, compositional variability, and record of climatic change expressed in the PLD, and to understand the astrobiological potential of the observable water ice deposits. Both mobile and static lander concepts were explored and could answer significant outstanding questions with spacecraft and instrument heritage from existing systems. These concepts will likely fall within the New Frontiers mission size range.

Discovery Missions

NASA does not intend to continue the Mars Scout program beyond the MAVEN mission, and instead plans to include Mars in the Discovery Program. The Discovery Program has utility for Mars studies. Discovery is not strategically directed, but is competitively selected, a process that has been highly effective at producing affordable, scientifically valuable missions. Examples of potential Mars missions that could be performed in the Discovery Program, in no priority order, include the following:

- A one-node geophysical pathfinder station,
- A polar science orbiter,
- A dual satellite atmospheric sounding and/or gravity mapping mission,
- An atmospheric sample collection and Earth return mission,
- A Phobos/Deimos surface exploration mission (See Chapter 4), and
- An in situ aerial mission to explore the region of the martian atmosphere and remnant magnetic field that is not easily accessible from orbit or from the surface

Summary

A combination of missions and technology development activities will advance the scientific study of Mars during the next decade. Such activities include the following:

- *Flagship missions*—The major focus of the next decade should be to initiate the Mars sample return campaign. The first and highest priority element of this campaign is the Mars Astrobiology Explorer-Cacher.
- *New Frontiers missions*—Although the committee looked at both Mars Geophysical Network and Mars Polar Climate missions (see Appendix D and G), due to cost constraints, neither was considered high priority relative to other medium-class missions (see Chapter 9).
- *Discovery missions*—Small spacecraft missions can make important contributions to the study of Mars.
- *Technology development*—The key technologies necessary to accomplish Mars sample return include: the Mars ascent vehicle; the rendezvous and capture of the orbiting sample return container; and the technologies to ensure that planetary protection requirements are met. Continued robust support for the development of instrument for future in situ exploration is appropriate.
- *Research support*—Vigorous research and analysis programs are needed to enhance the development and payoff of the orbital and surface missions and refine the sample collection requirements and laboratory analysis techniques needed for Mars sample return.

- *International cooperation*—While Mars sample return could proceed as a NASA-only program, international collaboration will be necessary to make real progress. The 2016 Trace Gas Orbiter mission is an appropriate start to a proposed joint NASA-ESA Mars program.

REFERENCES

1. Smith, D.E., M.T. Zuber, H.V. Frey, J.B. Garvin, J.W. Head, D.O. Muhleman, G.H. Pettengill, R.J. Phillips, S.C. Solomon, H.J. Zwally, W.B. Banerdt, et al. 2001. Mars Orbiter Laser Altimeter: Experiment summary after the first year of global mapping of Mars. *J. Geophys. Res.* 106:23689-23722.
Zuber, M.T., S.C. Solomon, R.J. Phillips, D.E. Smith, G.L. Tyler, O. Aharonson, G. Balmino, W.B. Banerdt, J.W. Head, C.L. Johnson, R.G. Lemoine, P.J. McGovern, G.A. Neumann, D.D. Rowlands, and S. Zhong. 2000. Internal structure and early thermal evolution of Mars from Mars Global Surveyor topography and gravity. *Science* 287:1788-1793.
M.C. Malin and K.S. Edgett. 2001. Mars Global Surveyor Mars Orbiter Camera: Interplanetary cruise through primary mission. *J. Geophys. Res.* 106:23429-23570.
P.R. Christensen, J.L. Bandfield, V.E. Hamilton, S.W. Ruff, H.H. Kieffer, T. Titus, M.C. Malin, R.V. Morris, M.D. Lane, R.N. Clark, B.M. Jakosky, et al. 2001a. The Mars Global Surveyor Thermal Emission Spectrometer experiment: Investigation description and surface science results. *J. Geophys. Res.* 106:23823-23871.
J.-P. Bibring, Y. Langevin, J.F. Mustard, F. Poulet, R. Arvidson, A. Gendrin, B. Gondet, N. Mangold, P. Pinet, F. Forget, and the OMEGA team. 2006. Global mineralogical and aqueous Mars history derived from OMEGA/Mars Express data. *Science* 312:400-404, doi:410.1126/science.1122659.
S.L. Murchie, J.F. Mustard, B.L. Ehlmann, R.E. Milliken, J.L. Bishop, N.K. McKeown, E.Z.N. Dobreá, F.P. Seelos, D.L. Buczkowski, and S.M. Wiseman. 2009. A synthesis of martian aqueous mineralogy after 1 Mars year of observations from the Mars Reconnaissance Orbiter. *J. Geophys. Res.* 114:E00D06.
W.C. Feldman, W.V. Boynton, R.L. Tokar, T.H. Prettyman, O. Gasnault, S.W. Squyres, R.C. Elphic, D.J. Lawrence, S.L. Lawson, S. Maurice, G.W. McKinney, K.R. Moore, and R.C. Reedy. 2002. Global distribution of neutrons from Mars: Results from Mars Odyssey. *Science* 297:75-78.
I. Mitrofanov, D. Anfimov, A. Kozyrev, M. Litvak, A. Sanin, V. Tret'yakov, A. Krylov, V. Shvetsov, W. Boynton, C. Shinohara, D. Hamara, and R.S. Saunders. 2002. Maps of subsurface hydrogen from the high energy neutron detector, Mars Odyssey. *Science* 297:78-81.
J.E.P. Connerney, M.H. Acuna, P.J. Wasilewski, G. Kletetschka, N.F. Ness, H. Reme, R.P. Lin, and D.L. Mitchell. 2001. The global magnetic field of Mars and implications for crustal evolution. *Geophys. Res. Lett.* 28(21):4015-4018.
M.D. Smith. 2004. Interannual variability in TES atmospheric observations of Mars during 1999-2003. *Icarus* 167:148-165.
2. R.E. Arvidson, C.C. Allen, D.J. Des Marais, J. Grotzinger, N. Hinners, B. Jakosky, J.F. Mustard, R. Phillips, and C.R. Webster. 2006. *Science Analysis of the November 3, 2005 Version of the Draft Mars Exploration Program Plan*. January. Available at <http://mepag.jpl.nasa.gov/reports/index.html>. White papers received by decadal survey: John F. Mustard, Seeking Signs of Life on a Terrestrial Planet: An Integrated Strategy for the Next Decade of Mars Exploration; Douglas Stetson, Mars Exploration 2016-2032: Rationale and Principles for a Strategic Program.
3. Mars Exploration Program Analysis Group (MEPAG). 2001. *Mars Scientific Goals, Objectives, Investigations, and Priorities*. Available at <http://mepag.jpl.nasa.gov/reports/index.html>. White papers received by decadal survey: Jeffrey R. Johnson, Summary of the Mars Science Goals, Objectives, Investigations, and Priorities.

R.E. Arvidson, C.C. Allen, D.J. Des Marais, J. Grotzinger, N. Hinners, B. Jakosky, J.F. Mustard, R. Phillips, and C.R. Webster. 2006. *Science Analysis of the November 3, 2005 Version of the Draft Mars Exploration Program Plan*. January. Available at <http://mepag.jpl.nasa.gov/reports/index.html>.

MEPAG. 2008. *Mars Scientific Goals, Objectives, Investigations, and Priorities: 2008*. September. Available at <http://mepag.jpl.nasa.gov/reports/index.html>

4. R.E. Kopp and J.L. Kirshvink. 2008. The identification and biogeochemical interpretation of fossil magnetotactic bacteria. *Earth Science Reviews* 86:42-61.

5. For a detailed discussion of these assumptions see, for example, National Research Council, *An Astrobiology Strategy for the Exploration of Mars*, The National Academies Press, Washington, D.C., 2007.

6. For a discussion of the possibilities opened by relaxing some of these assumptions see, for example, National Research Council, *The Limits of Organic Life in Planetary Systems*, The National Academies Press, Washington, D.C., 2007.

7. T.M. Hoehler. 2007. An energy balance concept for habitability. *Astrobiology* 7:824-838.

8. D.J. Des Marais, B.M. Jakosky, and B.M. Hynek. 2008. Astrobiological implications of Mars surface composition and properties. Pp. 599-623 in *The Martian Surface: Composition, Mineralogy and Physical Properties* (J.F. Bell III, ed.). Cambridge University Press.

9. J.P. Grotzinger. 2009. Mars Exploration, Comparative Planetary History, and the Promise of Mars Science Laboratory. *Nature Geoscience* 2:1-3.

10. J.D. Farmer and D.J. Des Marais. 1999. Exploring for a record of ancient Martian life. *J. Geophys. Res.* 103:26977-26995.

11. P.R. Christensen. 2006. Water at the poles and in permafrost regions on Mars. *Elements* 2:151-157.

12. National Research Council. 2007. *An Astrobiology Strategy for the Exploration of Mars*. The National Academies Press, Washington, D.C.

13. M.J. Mumma, G.L. Villanueva, R.E. Novak, T. Hewagama, B.P. Bonev, M.A. DiSanti, A.M. Mandell, and M.D. Smith. 2009. Strong release of methane on Mars in Northern Summer 2003. *Science* 323:1041-1045, doi: 10.1126/science.1165243.

14. J.A. Laskar, C.A. Correia, M. Gastineau, F. Joutel, B. Levrard, and P. Robutel. 2004. Long term evolution and chaotic diffusion of the insolation quantities of Mars. *Icarus* 170:343-364.

15. F. Forget, R.M. Haberle, F. Montmessin, B. Levrard, and J.W. Head. 2006. Formation of glaciers on Mars by atmospheric precipitation at high obliquity. *Science* 311:368-371.

N. Schorghofer. 2007. Dynamics of ice ages on Mars. *Nature* 449(7159):192-194.

16. J. Grotzinger, J.F. Bell III, W. Calvin, B.C. Clark, D. Fike, M. Golombek, R. Greeley, K.E. Herkenhoff, B. Jolliff, A.H. Knoll, M. Malin, et al. 2005. Stratigraphy, sedimentology and depositional environment of the Burns Formation, Meridiani Planum, Mars. *Earth Planet. Sci. Lett.* 240:11-72.

J.C. Andrews-Hanna, M.T. Zuber, R.E. Arvidson, and S.J. Wiseman. 2010. Mars hydrology: Meridiani playa deposits and the sedimentary record of Arabia Terra. *J. Geophys. Res.* doi: 10.1029/2009JE003485.

17. M.H. Carr. 2006. *The Surface of Mars*. Cambridge University Press.

V. Chevrier, F. Poulet, and J.P. Bibring. 2007. Early geochemical environment of Mars as determined from thermodynamics of phyllosilicates. *Nature* 448(7149):60-63.

S.L. Murchie, J.F. Mustard, B.L. Ehlmann, R.E. Milliken, J.L. Bishop, N.K. McKeown, E.Z.N. Dobra, F.P. Seelos, D.L. Buczkowski, and S.M. Wiseman. 2009. A synthesis of Martian aqueous mineralogy after 1 Mars year of observations from the Mars Reconnaissance Orbiter. *J. Geophys. Res.* 114:E00D06.

18. M.R. Walter and D.J. Des Marais. 1993. Preservation of biological information in thermal spring deposits: Developing a strategy for the search for fossil life on Mars. *Icarus*. 101:129-143.

- T.L. Segura, O.B. Toon, and A. Colaprete. 2008. Modeling the environmental effects of moderate-sized impacts on Mars. *Journal of Geophysical Research* 113(E11):E11007. White paper received by decadal survey: Andrew Steele, Astrobiology Sample Acquisition and Return.
19. M.H. Carr and J.W. Head III. 2003. Oceans on Mars: An assessment of the observation evidence and possible fate. *J. Geophys. Res.* 108:5042, doi:10.1029/2002JE001963.
20. J. Grotzinger, J.F. Bell III, W. Calvin, B.C. Clark, D. Fike, M. Golombek, R. Greeley, K.E. Herkenhoff, B. Jolliff, A.H. Knoll, M. Malin, et al. 2005. Stratigraphy, sedimentology and depositional environment of the Burns Formation, Meridiani Planum, Mars. *Earth Planet. Sci. Lett.* 240:11-72.
- R.E. Arvidson, S.W. Ruff, R.V. Morris, D.W. Ming, L.S. Crumpler, A.S. Yen, S.W. Squyres, R.J. Sullivan, J.F. Bell III, and N.A. Cabrol. 2008. Spirit Mars Rover Mission to the Columbia Hills, Gusev Crater: Mission overview and selected results from the Cumberland Ridge to Home Plate. *J. Geophys. Res.* 113(E12):E12S33.
21. L.E. Borg, D.J.D. Marais, D.W. Beaty, O. Aharonson, S.A. Benner, D.D. Bogard, J.C. Bridges, C.J. Budney, W.M. Calvin, B.C. Clark, J.L. Eigenbrode, et al. 2008. Science priorities for Mars sample return. *Astrobiology* 8:489-535.
22. J. Grotzinger, J.F. Bell III, W. Calvin, B.C. Clark, D. Fike, M. Golombek, R. Greeley, K.E. Herkenhoff, B. Jolliff, A.H. Knoll, M. Malin, et al. 2005. Stratigraphy, sedimentology and depositional environment of the Burns Formation, Meridiani Planum, Mars. *Earth Planet. Sci. Lett.* 240:11-72. White paper received by decadal survey: Lisa Pratt, Mars Astrobiology Explorer-Cacher (MAX-C): A Potential Rover Mission for 2018.
- R.E. Arvidson, S.W. Ruff, R.V. Morris, D.W. Ming, L.S. Crumpler, A.S. Yen, S.W. Squyres, R.J. Sullivan, J.F. Bell III, and N.A. Cabrol. 2008. Spirit Mars Rover Mission to the Columbia Hills, Gusev Crater: Mission overview and selected results from the Cumberland Ridge to Home Plate. *J. Geophys. Res.* 113(E12):E12S33.
23. National Research Council. 2007. *An Astrobiology Strategy for the Exploration of Mars*. The National Academies Press, Washington, D.C.
- iMARS Working Group 2008. *Preliminary Planning for an International Mars Sample Return Mission: Report of the International Mars Architecture for the Return of Samples (iMARS) Working Group*.
24. L.E. Borg, D.J.D. Marais, D.W. Beaty, O. Aharonson, S.A. Benner, D.D. Bogard, J.C. Bridges, C.J. Budney, W.M. Calvin, B.C. Clark, J.L. Eigenbrode, et al. 2008. Science priorities for Mars sample return. *Astrobiology* 8:489-535.
- L.M. Pratt, C. Allen, A.C. Allwood, A. Anbar, S.K. Atreya, D.W. Beaty, M.H. Carr, A. Crisp, D.J.D. Marais, J.A. Grant, D.P. Glavin, et al. 2009. *Mars Astrobiology Explorer-Cacher (MAX-C): A Potential Rover Mission for 2018*. Final report from the Mid-Range Rover Science Analysis Group (MRR-SAG). Posted by the Mars Exploration Program Analysis Group (MEPAG). November 10. Available at <http://mepag.jpl.nasa.gov/reports/>.
25. A.H. Knoll and J. Grotzinger. 2006. Water on Mars and the prospect of martian life. *Elements* 2(3):169.
- T.M. Hoehler. 2007. An energy balance concept for habitability. *Astrobiology* 7:824-838.
26. J. Grotzinger, J.F. Bell III, W. Calvin, B.C. Clark, D. Fike, M. Golombek, R. Greeley, K.E. Herkenhoff, B. Jolliff, A.H. Knoll, M. Malin, et al. 2005. Stratigraphy, sedimentology and depositional environment of the Burns Formation, Meridiani Planum, Mars. *Earth Planet. Sci. Lett.* 240:11-72. White paper received by decadal survey: Lisa Pratt, Mars Astrobiology Explorer-Cacher (MAX-C): A Potential Rover Mission for 2018.
- R.E. Arvidson, S.W. Ruff, R.V. Morris, D.W. Ming, L.S. Crumpler, A.S. Yen, S.W. Squyres, R.J. Sullivan, J.F. Bell III, and N.A. Cabrol. 2008. Spirit Mars Rover Mission to the Columbia Hills, Gusev Crater: Mission overview and selected results from the Cumberland Ridge to Home Plate. *J. Geophys. Res.* 113(E12):E12S33.

27. J. Grotzinger, J.F. Bell III, W. Calvin, B.C. Clark, D. Fike, M. Golombek, R. Greeley, K.E. Herkenhoff, B. Jolliff, A.H. Knoll, M. Malin, et al. 2005. Stratigraphy, sedimentology and depositional environment of the Burns Formation, Meridiani Planum, Mars. *Earth Planet. Sci. Lett.* 240:11-72. White paper received by decadal survey: Lisa Pratt, Mars Astrobiology Explorer-Cacher (MAX-C): A Potential Rover Mission for 2018.

R.E. Arvidson, S.W. Ruff, R.V. Morris, D.W. Ming, L.S. Crumpler, A.S. Yen, S.W. Squyres, R.J. Sullivan, J.F. Bell III, and N.A. Cabrol. 2008. Spirit Mars Rover Mission to the Columbia Hills, Gusev Crater: Mission overview and selected results from the Cumberland Ridge to Home Plate. *J. Geophys. Res.* 113(E12):E12S33.

28. J. Grotzinger, J.F. Bell III, W. Calvin, B.C. Clark, D. Fike, M. Golombek, R. Greeley, K.E. Herkenhoff, B. Jolliff, A.H. Knoll, M. Malin, et al. 2005. Stratigraphy, sedimentology and depositional environment of the Burns Formation, Meridiani Planum, Mars. *Earth Planet. Sci. Lett.* 240:11-72. White paper received by decadal survey: Lisa Pratt, Mars Astrobiology Explorer-Cacher (MAX-C): A Potential Rover Mission for 2018.

R.E. Arvidson, S.W. Ruff, R.V. Morris, D.W. Ming, L.S. Crumpler, A.S. Yen, S.W. Squyres, R.J. Sullivan, J.F. Bell III, and N.A. Cabrol. 2008. Spirit Mars Rover Mission to the Columbia Hills, Gusev Crater: Mission overview and selected results from the Cumberland Ridge to Home Plate. *J. Geophys. Res.* 113(E12):E12S33.

29. M.D. Smith. 2004. Interannual variability in TES atmospheric observations of Mars during 1999-2003. *Icarus* 167:148-165.

A. Kleinböhl, J.T. Schofield, D.M. Kass, W.A. Abdou, C.R. Backus, B. Sen, J.H. Shirley, W.G. Lawson, M.I. Richardson, F.W. Taylor, N.A. Teanby, and D.J. McCleese. 2009. Mars Climate Sounder limb profile retrieval of atmospheric temperature, pressure, and dust and water ice opacity. *J. Geophys. Res.* 113:E10006.

30. T. Fouchet, E. Lellouch, N.I. Ignatiev, F. Forget, D.V. Titov, M. Tschimmel, F. Montmessin, V. Formisano, M. Giuranna, A. Maturilli, and T. Encrenaz. 2007. Martian water vapor: Mars Express PFS/LW observations. *Icarus* 90:32-49.

A. Whiteway, L. Komguem, C. Dickinson, C. Cook, M. Illnicki, J. Seabrook, V. Popovici, T.J. Duck, R. Davy, P.A. Taylor, J. Pathak, et al. 2009. Mars water-ice clouds and precipitation. *Science* 325:68.

31. H.H. Kieffer, P.R. Christensen, and T.N. Titus. 2006. CO₂ jets formed by sublimation beneath translucent slab ice in Mars' seasonal south polar ice cap. *Nature* 442:793-796, doi: 710.1038/nature04945.

32. S. Byrne and A.P. Ingersoll. 2003. A sublimation model for martian south polar ice features. *Science* 299:1051-1053.

J.-P. Bibring, Y. Langevin, F. Poulet, A. Gendrin, B. Gondet, M. Berthe, A. Soufflot, P. Drossart, M. Combes, G. Bellucci, V. Moroz, N. Mangold, B. Schmitt, and OMEGA team 2004. Perennial water ice identified in the south polar cap of Mars. *Nature* 428:627-630.

33. S. Byrne and A.P. Ingersoll. 2003. A sublimation model for martian south polar ice features. *Science* 299:1051-1053.

34. A. Kleinböhl, J.T. Schofield, D.M. Kass, W.A. Abdou, C.R. Backus, B. Sen, J.H. Shirley, W.G. Lawson, M.I. Richardson, F.W. Taylor, N.A. Teanby, and D.J. McCleese. 2009. Mars Climate Sounder limb profile retrieval of atmospheric temperature, pressure, and dust and water ice opacity. *J. Geophys. Res.* 113:E10006.

F. Forget, F. Montmessin, J. Bertaux, F. González-Galindo, S. Lebonnois, E. Quémerais, A. Reberac, E. Dimarellis, and M. A. López-Valverde. 2009. Density and temperatures of the upper martian atmosphere measured by stellar occultations with Mars Express SPICAM. *J. Geophys. Res.* 114:E01004.

35. M.J. Mumma, G.L. Villanueva, R.E. Novak, T. Hewagama, B.P. Bonev, M.A. DiSanti, A.M. Mandell, and M.D. Smith. 2009. Strong release of methane on Mars in Northern Summer 2003. *Science* 323:1041-1045, DOI: 10.1126/science.1165243.

36. F. Lefèvre and F. Forget. 2009. Observed variations of methane on Mars unexplained by known atmospheric chemistry and physics. *Nature* 460:720-723.
37. J.W. Head, J.F. Mustard, M.A. Kreslavsky, R.E. Milliken, and D.R. Marchant. 2003. Recent ice ages on Mars. *Nature* 426:797-802.
- M.A. Mischna, M.I. Richardson, R.J. Wilson, and D.J. McCleese. 2003. On the orbital forcing of Martian water and CO₂ cycles: A general circulation model study with simplified volatile schemes. *J. Geophys. Res.* 108:5062, doi:5010.1029/2003JE002051.
- B. Levrard, F. Forget, F. Montmessin, and J. Laskar. 2004. Recent ice-rich deposits formed at high latitudes on Mars by sublimation of unstable equatorial ice during low obliquity. *Nature* 431:1072-1075.
- F. Forget, R.M. Haberle, F. Montmessin, B. Levrard, and J.W. Head. 2006. Formation of glaciers on Mars by atmospheric precipitation at high obliquity. *Science* 311:368-371.
38. B. Levrard, F. Forget, F. Montmessin, and J. Laskar. 2004. Recent ice-rich deposits formed at high latitudes on Mars by sublimation of unstable equatorial ice during low obliquity. *Nature* 431:1072-1075.
39. M.T. Mellon, R.E. Arvidson, H.G. Sizemore, M.L. Searls, D.L. Blaney, S. Cull, M.H. Hecht, T.L. Heet, H.U. Keller, M.T. Lemmon, W.J. Markiewicz, D.W. Ming, R.V. Morris, W.T. Pike, and A.P. Zent. 2009. Ground ice at the Phoenix landing site: Stability state and origin. *J. Geophys. Res.* 114:E00E07.
40. White papers received by decadal survey: Michael D. Smith, Mars Trace Gas Mission: Scientific Goals and Measurement Objectives; Michael A. Mischna, Atmospheric Science Research Priorities for Mars; Timothy N. Titus, Mars Polar Science for the Next Decade.
41. M.H. Carr and J.W. Head III. 2003. Oceans on Mars: An assessment of the observation evidence and possible fate. *J. Geophys. Res.* 108:5042, doi:10.1029/2002JE001963.
- M.C. Malin and K.S. Edgett. 2003. Evidence for persistent flow and aqueous sedimentation on early Mars. *Science* 302:1931-1934.
- J.-P. Bibring, Y. Langevin, J.F. Mustard, F. Poulet, R. Arvidson, A. Gendrin, B. Gondet, N. Mangold, P. Pinet, F. Forget, and OMEGA team. 2006. Global mineralogical and aqueous Mars history derived from OMEGA/Mars Express data. *Science* 312:400-404, doi:410.1126/science.1122659.
- J.C. Andrews-Hanna, M.T. Zuber, R.E. Arvidson, and S.J. Wiseman. 2010. Mars hydrology: Meridiani playa deposits and the sedimentary record of Arabia Terra. *J. Geophys. Res.* 115:E06002. doi:10.1029/2009JE003485.
42. R.M. Haberle. 1998. Early Mars climate models. *J. Geophys. Res.* 103:28467-28479.
43. S.S. Johnson, M.A. Mischna, T.L. Grove, and M.T. Zuber. 2008. Sulfur-induced greenhouse warming on early Mars. *J. Geophys. Res.* 113:E08005.
44. F. Forget and R.T. Pierrehumbert. 1997. Warming early Mars with carbon dioxide clouds that scatter infrared radiation. *Science* 278(5341):1273.
45. T.L. Segura, O.B. Toon, and A. Colaprete. 2008. Modeling the environmental effects of moderate-sized impacts on Mars. *Journal of Geophysical Research* 113(E11):E11007.
46. White paper received by decadal survey: Michael Hecht, Next Steps in Mars Polar Science.
47. S.C. Solomon, O. Aharonson, J.M. Aurnou, W.B. Banerdt, M.H. Carr, A.J. Dombard, H.V. Frey, M.P. Golombek, S.A. Hauck, and J.W. Head III. 2005. New perspectives on ancient Mars. *Science* 307(5713):1214.
- J.F. Mustard, S.L. Murchie, S.M. Pelkey, B.L. Ehlmann, R.E. Milliken, J.A. Grant, J.P. Bibring, F. Poulet, J. Bishop, and E.N. Dobreá. 2008. Hydrated silicate minerals on Mars observed by the Mars Reconnaissance Orbiter CRISM instrument. *Nature* 454(7202):305-309.
- J.-P. Bibring, Y. Langevin, J.F. Mustard, F. Poulet, R. Arvidson, A. Gendrin, B. Gondet, N. Mangold, P. Pinet, F. Forget, and OMEGA team. 2006. Global mineralogical and aqueous Mars history derived from OMEGA/Mars Express data. *Science* 312:400-404, doi:410.1126/science.1122659.
48. M.H. Carr. 2006. *The Surface of Mars*. Cambridge University Press.

PREPUBLICATION COPY—SUBJECT TO FURTHER EDITORIAL CORRECTION

- B.M. Jakosky and R.J. Phillips. 2001. Mars' volatile and climate history. *Nature* 412(6843):237-244.
49. N.J. Tosca and S. McLennan. 2006. Chemical divides and evaporite assemblages on Mars. *Earth and Planetary Science Letters* 241:21-31.
- N.J. Tosca, S.M. McLennan, B.C. Clark, J.P. Grotzinger, J.A. Hurowitz, A.H. Knoll, C. Schröder, and S.W. Squyres. 2005. Geochemical modeling of evaporation processes on Mars: Insight from the sedimentary record at Meridiani Planum. *Earth and Planetary Science Letters* 240(1):122-148.
- P.L. King and H.Y. McSween, Jr. 2005. Effects of H₂O, pH, and oxidation state on the stability of Fe minerals on Mars. *Journal of Geophysical Research* 110(E12):E12S10.
50. J.-P. Bibring, Y. Langevin, J.F. Mustard, F. Poulet, R. Arvidson, A. Gendrin, B. Gondet, N. Mangold, P. Pinet, F. Forget, and OMEGA team. 2006. Global mineralogical and aqueous Mars history derived from OMEGA/Mars Express data. *Science* 312:400-404, doi:410.1126/science.1122659.
51. S.L. Murchie, J.F. Mustard, B.L. Ehlmann, R.E. Milliken, J.L. Bishop, N.K. McKeown, E.Z.N. Dobreá, F.P. Seelos, D.L. Buczkowski, and S.M. Wiseman. 2009. A synthesis of martian aqueous mineralogy after 1 Mars year of observations from the Mars Reconnaissance Orbiter. *J. Geophys. Res.* 114:E00D06.
52. P.R. Christensen, R.V. Morris, M.D. Lane, J.L. Bandfield, and M.C. Malin. 2001b. Global mapping of martian hematite mineral deposits: Remnants of water-driven processes on early Mars. *J. Geophys. Res.* 106:23873-23885.
53. J. Grotzinger, J.F. Bell III, W. Calvin, B.C. Clark, D. Fike, M. Golombek, R. Greeley, K.E. Herkenhoff, B. Jolliff, A.H. Knoll, M. Malin, et al. 2005. Stratigraphy, sedimentology and depositional environment of the Burns Formation, Meridiani Planum, Mars. *Earth Planet. Sci. Lett.* 240:11-72.
54. R.E. Arvidson, S.W. Ruff, R.V. Morris, D.W. Ming, L.S. Crumpler, A.S. Yen, S.W. Squyres, R.J. Sullivan, J.F. Bell III, and N.A. Cabrol. 2008. Spirit Mars Rover Mission to the Columbia Hills, Gusev Crater: Mission overview and selected results from the Cumberland Ridge to Home Plate. *J. Geophys. Res.* 113(E12):E12S33.
55. P.H. Smith, L.K. Tamppari, R.E. Arvidson, D. Bass, D. Blaney, W.V. Boynton, A. Carswell, D.C. Catling, B.C. Clark, and T. Duck. 2009. H₂O at the Phoenix landing site. *Science* 325(5936):58.
56. M.H. Hecht, S.P. Kounaves, R.C. Quinn, S.J. West, S.M.M. Young, D.W. Ming, D.C. Catling, B.C. Clark, W.V. Boynton, and J. Hoffman. 2009. Detection of perchlorate and the soluble chemistry of martian soil at the Phoenix lander site. *Science* 325(5936):64.
57. J.-P. Bibring, Y. Langevin, J.F. Mustard, F. Poulet, R. Arvidson, A. Gendrin, B. Gondet, N. Mangold, P. Pinet, F. Forget, and OMEGA team 2006. Global mineralogical and aqueous Mars history derived from OMEGA/Mars Express data. *Science* 312:400-404, doi:410.1126/science.1122659.
- J.F. Mustard, S.L. Murchie, S.M. Pelkey, B.L. Ehlmann, R.E. Milliken, J.A. Grant, J.P. Bibring, F. Poulet, J. Bishop, and E.N. Dobreá. 2008. Hydrated silicate minerals on Mars observed by the Mars Reconnaissance Orbiter CRISM instrument. *Nature* 454(7202):305-309.
- S.L. Murchie, J.F. Mustard, B.L. Ehlmann, R.E. Milliken, J.L. Bishop, N.K. McKeown, E.Z.N. Dobreá, F.P. Seelos, D.L. Buczkowski, and S.M. Wiseman. 2009. A synthesis of Martian aqueous mineralogy after 1 Mars year of observations from the Mars Reconnaissance Orbiter. *J. Geophys. Res.* 114:E00D06.
- B.L. Ehlmann, J.F. Mustard, S.L. Murchie, F. Poulet, J.L. Bishop, A.J. Brown, W.M. Calvin, R.N. Clark, D.J.D. Marais, and R.E. Milliken. 2008. Orbital identification of carbonate-bearing rocks on Mars. *Science* 322(5909):1828.
- M.M. Osterloo, V.E. Hamilton, J.L. Bandfield, T.D. Glotch, A.M. Baldridge, P.R. Christensen, L.L. Tornabene, and F.S. Anderson. 2008. Chloride-bearing materials in the southern highlands of Mars. *Science* 319(5870):1651-1654, doi: 10.1126/science.1150690.
58. B.L. Ehlmann, J.F. Mustard, and S.L. Murchie. 2010. Geologic setting of serpentine deposits on Mars. *Geophys. Res. Lett.* 37:L06201.

59. B.L. Ehlmann, J.F. Mustard, S.L. Murchie, F. Poulet, J.L. Bishop, A.J. Brown, W.M. Calvin, R.N. Clark, D.J.D. Marais, and R.E. Milliken. 2008. Orbital identification of carbonate-bearing rocks on Mars. *Science* 322(5909):1828.
60. R.V. Morris, S.W. Ruff, R. Gellert, D.W. Ming, R.E. Arvidson, B.C. Clark, D.C. Golden, K. Siebach, G. Klingelhöfer, C. Schröder, I. Fleischer, A.S. Yen, and S.W. Squyres. 2010. Identification of carbonate-rich outcrops on Mars by the Spirit Rover. *Science* 329 no. 5990 pp. 421-424.
61. S. Stanley, L. Elkins-Tanton, M.T. Zuber, and E.M. Parmentier. 2008. Mars' paleomagnetic field as the result of a single-hemisphere dynamo. *Science* 321(5897):1822.
- M.M. Marinova, O. Aharonson, and E. Asphaug. 2008. Mega-impact formation of the Mars hemispheric dichotomy. *Nature* 453(7199):1216-1219.
62. B.M. Jakosky and R.J. Phillips 2001. Mars' volatile and climate history. *Nature* 412(6843):237-244.
63. J.C. Andrews-Hanna, M.T. Zuber, R.E. Arvidson, and S.J. Wiseman. 2010. Mars hydrology: Meridiani playa deposits and the sedimentary record of Arabia Terra. *J. Geophys. Res.* 115:E06002. doi: 10.1029/2009JE003485.
64. S.C. Solomon, O. Aharonson, J.M. Aurnou, W.B. Banerdt, M.H. Carr, A.J. Dombard, H.V. Frey, M.P. Golombek, S.A. Hauck, and J.W. Head III. 2005. New perspectives on ancient Mars. *Science* 307(5713):1214.
- S. Stanley, L. Elkins-Tanton, M.T. Zuber, and E.M. Parmentier. 2008. Mars' paleomagnetic field as the result of a single-hemisphere dynamo. *Science* 321(5897):1822.
65. M.H. Carr. 2006. *The Surface of Mars*. Cambridge University Press.
66. L.S. Rothman, D. Jacquemart, A. Barbe, D.C. Benner, M. Birk, L.R. Brown, M.R. Carleer, C. Chackerian, Jr., K. Chance, L.H. Coudert, V. Dana, et al. 2005. The HITRAN 2004 molecular spectroscopic database. *Journal of Quantitative Spectroscopy* 96:139-204.
67. D.E. Smith, M.T. Zuber, H.V. Frey, J.B. Garvin, J.W. Head, D.O. Muhleman, G.H. Pettengill, R.J. Phillips, S.C. Solomon, H.J. Zwally, W.B. Banerdt, et al. 2001. Mars Orbiter Laser Altimeter: Experiment summary after the first year of global mapping of Mars. *J. Geophys. Res.* 106: 23689-23722.
68. P.R. Christensen, J.L. Bandfield, V.E. Hamilton, S.W. Ruff, H.H. Kieffer, T. Titus, M.C. Malin, R.V. Morris, M.D. Lane, R.N. Clark, B.M. Jakosky, et al. 2001a. The Mars Global Surveyor Thermal Emission Spectrometer experiment: Investigation description and surface science results. *J. Geophys. Res.* 106:23823-23871.
- J.-P. Bibring, Y. Langevin, J.F. Mustard, F. Poulet, R. Arvidson, A. Gendrin, B. Gondet, N. Mangold, P. Pinet, F. Forget, and OMEGA team. 2006. Global mineralogical and aqueous Mars history derived from OMEGA/Mars Express data. *Science* 312:400-404, doi:410.1126/science.1122659.
- J.F. Mustard, S.L. Murchie, S.M. Pelkey, B.L. Ehlmann, R.E. Milliken, J.A. Grant, J.P. Bibring, F. Poulet, J. Bishop, and E.N. Dobreá. 2008. Hydrated silicate minerals on Mars observed by the Mars Reconnaissance Orbiter CRISM instrument. *Nature* 454(7202):305-309.
- S.L. Murchie, J.F. Mustard, B.L. Ehlmann, R.E. Milliken, J.L. Bishop, N.K. McKeown, E.Z.N. Dobreá, F.P. Seelos, D.L. Buczkowski, and S.M. Wiseman. 2009. A synthesis of martian aqueous mineralogy after 1 Mars year of observations from the Mars Reconnaissance Orbiter. *J. Geophys. Res.* 114:E00D06.
69. M.C. Malin and K.S. Edgett. 2001. Mars Global Surveyor Mars Orbiter Camera: Interplanetary cruise through primary mission. *J. Geophys. Res.* 106:23429-23570.
70. A.S. McEwen, C.J. Hansen, W.A. Delamere, E.M. Eliason, K.E. Herkenhoff, L. Keszthelyi, V.C. Gulick, R.L. Kirk, M.T. Mellon, and J.A. Grant. 2007. A closer look at water-related geologic activity on Mars. *Science* 317(5845):1706.
71. G.A. Neumann, M.T. Zuber, M.A. Wieczorek, P.J. McGovern, F.G. Lemoine, and D.E. Smith. 2004. Crustal structure of Mars from gravity and topography. *J. Geophys. Res.* 109:E08002.

72. White papers received by decadal survey: Bruce Banerdt, The Rationale for a Long-Lived Geophysical Network Mission To Mars; Thomas Ruedas, Seismological Investigations of Mars's Deep Interior.
73. M.T. Rosing. 1999. 13C-depleted carbon microparticles in >3700-Ma sea-floor sedimentary rocks from West Greenland. *Science* 283:674-676.
74. A.H. Knoll and J. Grotzinger. 2006. Water on Mars and the prospect of martian life. *Elements* 2(3):169.
75. J.F. Kasting, D.P. Whitmire, and R.T. Reynolds. 1993. Habitable zones around main sequence stars. *Icarus* 101(1):108-128.
76. National Research Council. 2002. *Safe on Mars: Precursor Measurements Necessary to Support Human Operations on the Martian Surface*. The National Academies Press, Washington, D.C.
77. National Research Council. 1978. *Strategy for the Exploration of the Inner Planets: 1977-1987*. National Academy Press, Washington, D.C.
- National Research Council. 1990. *The Search for Life's Origins: Progress and Future Directions in Planetary Biology and Chemical Evolution*. National Academy Press, Washington, D.C.
- National Research Council. 1994. *An Integrated Strategy for the Planetary Sciences: 1995-2010*. National Academy Press, Washington, D.C.
- National Research Council. 1997. *Mars Sample Return: Issues and Recommendations*. National Academy Press, Washington, D.C.
- National Research Council. 2007. *An Astrobiology Strategy for the Exploration of Mars*. The National Academies Press, Washington, D.C.
78. Mars Exploration Program Analysis Group (MEPAG). 2001. *Mars Scientific Goals, Objectives, Investigations, and Priorities*. Available at <http://mepag.jpl.nasa.gov/reports/index.html>.
- L.M. Pratt, C. Allen, A.C. Allwood, A. Anbar, S.K. Atreya, D.W. Beaty, M.H. Carr, A. Crisp, D.J.D. Marais, J.A. Grant, D.P. Glavin, et al. 2009. *Mars Astrobiology Explorer-Cacher (MAX-C): A Potential Rover Mission for 2018*. Final report from the Mid-Range Rover Science Analysis Group (MRR-SAG). Posted by the Mars Exploration Program Analysis Group (MEPAG). November 10. Available at <http://mepag.jpl.nasa.gov/reports/>.
- Mars Exploration Program Analysis Group Next Decade Science Analysis Group. 2008. *Science Priorities for Mars Sample Return*. March. Available at <http://mepag.jpl.nasa.gov/reports/ndsag.html>.
- White papers received by decadal survey: Lars Borg, A Consensus Vision for Mars Sample Return; Jack Farmer, Astrobiology Research and Technology Priorities for Mars; Samad Hayati, Strategic Technology Development for Future Mars Missions; Bruce M. Jakosky, Are there Signs of Life on Mars? A Scientific Rationale for a Mars Sample-Return Campaign as the Next Step in Solar System Exploration; John F. Mustard, Seeking Signs of Life on a Terrestrial Planet: An Integrated Strategy for the Next Decade of Mars Exploration; Lisa Pratt, Mars Astrobiology Explorer-Cacher (MAX-C): A Potential Rover Mission for 2018; Andrew Steele, Astrobiology Sample Acquisition and Return; Allan H. Treiman, Groundbreaking Sample Return from Mars: The Next Giant Leap in Understanding the Red Planet.
79. iMARS Working Group 2008. *Preliminary Planning for an International Mars Sample Return Mission: Report of the International Mars Architecture for the Return of Samples (iMARS) Working Group*.
80. White papers received by decadal survey: Lars Borg, A Consensus Vision for Mars Sample Return; Jack Farmer, Astrobiology Research and Technology Priorities for Mars; Samad Hayati, Strategic Technology Development for Future Mars Missions; Bruce M. Jakosky, Are there Signs of Life on Mars? A Scientific Rationale for a Mars Sample-Return Campaign as the Next Step in Solar System Exploration; John F. Mustard, Seeking Signs of Life on a Terrestrial Planet: An Integrated Strategy for the Next Decade of Mars Exploration; Lisa Pratt, Mars Astrobiology Explorer-Cacher (MAX-C): A Potential Rover Mission for 2018; Andrew Steele, Astrobiology Sample Acquisition and Return; Allan H.

Treiman, Groundbreaking Sample Return from Mars: The Next Giant Leap in Understanding the Red Planet

81. Numerous previous studies have consistently pointed out the important contributions that sample-return missions from planetary bodies can make to virtually every area of solar system exploration in general, and to Mars exploration in particular. For general discussions of the importance of sample-return missions see the following and references therein:

M.J. Drake, W.V. Boynton, and D.P. Blanchard, “The Case for Planetary Sample Return Missions: 1. Origin of the Solar System,” *Eos* 68:105, 111-113, 1987.

J.L. Gooding, M.H. Carr, and C.P. McKay, “The Case for Planetary Sample Return Missions: 2. History of Mars,” *Eos* 70:745, 754-755, 1989.

G. Ryder, P.D. Spudis, and G.J. Taylor, “The Case for Planetary Sample Return Missions: 3. The Origin and Evolution of the Moon and Its Environment,” *Eos* 70:1495, 1505-1509, 1989.

T.D. Swindle, J.S. Lewis, and L.A. McFadden, “The Case for Planetary Sample Return Missions: 4. Near-Earth Asteroids and the History of Planetary Formation,” *Eos* 72:473, 479-480, 1991.

National Research Council, *Assessment of Mars Science and Mission Priorities*, The National Academies Press, Washington, D.C., 2001, pp. 83-88.

82. A Mars sample-return mission has been an essential component of the Mars exploration strategies advocated by the National Research Council for 30 years. For specific discussions, see the following:

National Research Council, *Strategy for the Exploration of the Inner Planets: 1977-1987*, National Academy of Sciences, Washington, D.C., 1978.

National Research Council, *Update to Strategy for Exploration of the Inner Planets*, National Academy Press, Washington, D.C., 1990.

National Research Council, *International Cooperation for Mars Exploration and Sample Return*, National Academy Press, Washington, D.C., 1990, pp. 1, 3, and 25.

National Research Council, *An Integrated Strategy for the Planetary Sciences: 1995-2010*, National Academy Press, Washington, D.C., 1994.

National Research Council, *Review of NASA’s Planned Mars Program*, National Academy Press, Washington, D.C., 1996, pp. 3, 26, and 29.

National Research Council, *Assessment of Mars Science and Mission Priorities*, The National Academies Press, Washington, D.C., 2001, pp. 3, 83-88, and 99-102.

National Research Council, *New Frontiers in the Solar System: An Integrated Exploration Strategy*, The National Academies Press, Washington, D.C., 2003, pp. 85-87.

National Research Council, *An Astrobiology Strategy for the Exploration of Mars*, The National Academies Press, Washington, D.C., 2007, pp.8-9 and 105-107.

83. Mars Exploration Program Analysis Group Next Decade Science Analysis Group. 2008. *Science Priorities for Mars Sample Return*. March. Available at <http://mepag.jpl.nasa.gov/reports/ndsag.html>.

L.M. Pratt, C. Allen, A.C. Allwood, A. Anbar, S.K. Atreya, D.W. Beaty, M.H. Carr, A. Crisp, D.J.D. Marais, J.A. Grant, D.P. Glavin, et al. 2009. *Mars Astrobiology Explorer-Cacher (MAX-C): A Potential Rover Mission for 2018*. Final report from the Mid-Range Rover Science Analysis Group (MRR-SAG). Posted by the Mars Exploration Program Analysis Group (MEPAG). November 10. Available at <http://mepag.jpl.nasa.gov/reports/>.

84. Mars Exploration Program Analysis Group Next Decade Science Analysis Group. 2008. *Science Priorities for Mars Sample Return*. March. Available at <http://mepag.jpl.nasa.gov/reports/ndsag.html>.

L.M. Pratt, C. Allen, A.C. Allwood, A. Anbar, S.K. Atreya, D.W. Beaty, M.H. Carr, A. Crisp, D.J.D. Marais, J.A. Grant, D.P. Glavin, et al. 2009. *Mars Astrobiology Explorer-Cacher (MAX-C): A Potential Rover Mission for 2018*. Final report from the Mid-Range Rover Science Analysis Group

(MRR-SAG). Posted by the Mars Exploration Program Analysis Group (MEPAG). November 10. Available at <http://mepag.jpl.nasa.gov/reports/>.

85. Mars Exploration Program Analysis Group Next Decade Science Analysis Group. 2008. *Science Priorities for Mars Sample Return*. March. Available at <http://mepag.jpl.nasa.gov/reports/ndsag.html>.

L.E. Borg, D.J.D. Marais, D.W. Beaty, O. Aharonson, S.A. Benner, D.D. Bogard, J.C. Bridges, C.J. Budney, W.M. Calvin, B.C. Clark, J.L. Eigenbrode, et al. 2008. Science priorities for Mars sample return. *Astrobiology* 8:489-535.

86. Mars Exploration Program Analysis Group Next Decade Science Analysis Group. 2008. *Science Priorities for Mars Sample Return*. March. Available at <http://mepag.jpl.nasa.gov/reports/ndsag.html>.

L.E. Borg, D.J.D. Marais, D.W. Beaty, O. Aharonson, S.A. Benner, D.D. Bogard, J.C. Bridges, C.J. Budney, W.M. Calvin, B.C. Clark, J.L. Eigenbrode, et al. 2008. Science priorities for Mars sample return. *Astrobiology* 8:489-535.

87. Mars Exploration Program Analysis Group Next Decade Science Analysis Group. 2008. *Science Priorities for Mars Sample Return*. March. Available at <http://mepag.jpl.nasa.gov/reports/ndsag.html>.

L.E. Borg, D.J.D. Marais, D.W. Beaty, O. Aharonson, S.A. Benner, D.D. Bogard, J.C. Bridges, C.J. Budney, W.M. Calvin, B.C. Clark, J.L. Eigenbrode, et al. 2008. Science priorities for Mars sample return. *Astrobiology* 8:489-535.

88. See, for example, the Samad Hayati, Strategic Technology Development for Future Mars Missions, white paper received by decadal survey.

89. M.J. Mumma, G.L. Villanueva, R.E. Novak, T. Hewagama, B.P. Bonev, M.A. DiSanti, A.M. Mandell, and M.D. Smith. 2009. Strong release of methane on Mars in Northern Summer 2003. *Science* 323:1041-1045, doi: 10.1126/science.1165243.

7

The Giant Planets: Local Laboratories and Ground Truth for Planets Beyond

Jupiter, Saturn, Uranus, and Neptune are the giants of the solar system. These four planets define the dominant characteristics of our planetary system in multiple ways, e.g., they contain over 99 percent of the solar system's mass and total angular momentum. Their formation and evolution have governed the history of the solar system. As the last planetary exploration decadal survey articulated, “the giant planet story is the story of the solar system.”¹

One of the most significant advances (Table 7.1) since the last decadal survey has been the discovery that giant planets reside in the planetary systems discovered around other stars, as well. To date, the vast majority of known planets around other stars (exoplanets) are giants close to their parent stars, though observational bias plays a role in the statistics. This chapter discusses the four local giant planets, placing them in the context of the growing population of exoplanets and our understanding of our own solar system. Both remote and in situ measurements of their outer atmospheric compositions are discussed, as well as external measurements that probe their deeper interiors both through their gravity fields and through their magnetic fields and magnetospheric interactions with the Sun. This chapter also includes the ring systems and smaller moons of these worlds, which together with the larger moons, effectively constitute miniature solar systems. This chapter explicitly excludes discussion of the largest moons of the giant planets, which are addressed in a separate chapter of this report.

Studying the giant planets is vital to addressing many of the priority questions developed in Chapter 3. For example, central to the theme, Building New Worlds, is the question “how did the giant planets and their satellite systems accrete, and is there evidence that they migrated to new orbital positions?” Formation and migration of the giant planets are believed to have played a dominant role in the sculpture and future evolution of the entire solar system. The giant planets are particularly important for delving into several key questions in the Workings of Solar Systems theme. For example, “how do the giant planets serve as laboratories to understand Earth, the solar system, and extrasolar planetary systems?” Most of the extrasolar planets that have been discovered to date are giants, with a spectrum of types that includes our own ice and gas giants; close-up study of the giants of our own solar system provides crucial insights about what we are seeing around distant stars. Our giant planets, particularly Jupiter, are central to the question: “what solar system bodies endanger and what mechanisms shield Earth's biosphere?”—in fact Jupiter may overall shield Earth from impact. The atmospheres of the giant planets provide important laboratories in addressing “can understanding the roles of physics, chemistry, geology, and dynamics in driving planetary atmospheres and climates lead to a better understanding of climate change on Earth?” Finally, harboring most of the mass and energy of our planetary system, the giant planets are a major element in understanding “how have the myriad chemical and physical processes that shaped the solar system operated, interacted, and evolved over time?”

SCIENCE GOALS FOR THE STUDY OF GIANT PLANETS

Giant planets dominated the history of planetary evolution: the processes of their formation and migration sculpted the nascent solar system into the habitable environment of today. The materials that comprise the giant planets preserve the chemical signatures of the primitive nebular material from which

the solar system formed. Understanding the interiors and atmospheres of these planets and their attendant moons, rings, and fields both gravitational and magnetic illuminates the properties and processes that occur throughout the solar system. A key lesson from studying giant planets is this: there is no such thing as a static planet; all planets (including Earth) constantly change due to internal and external processes. Giant planets illustrate these changes in many ways, including weather, response to impacts, aurorae, and orbital migration.

We also must understand the properties and processes acting in the solar system in order to extrapolate from the basic data we have on exoplanetary systems to understand how they formed and evolved. In the solar system and possibly in other planetary systems, the properties of the giants and ongoing processes driven by the giants can ultimately lead to the formation of a biosphere-sustaining terrestrial planet.^{2,3}

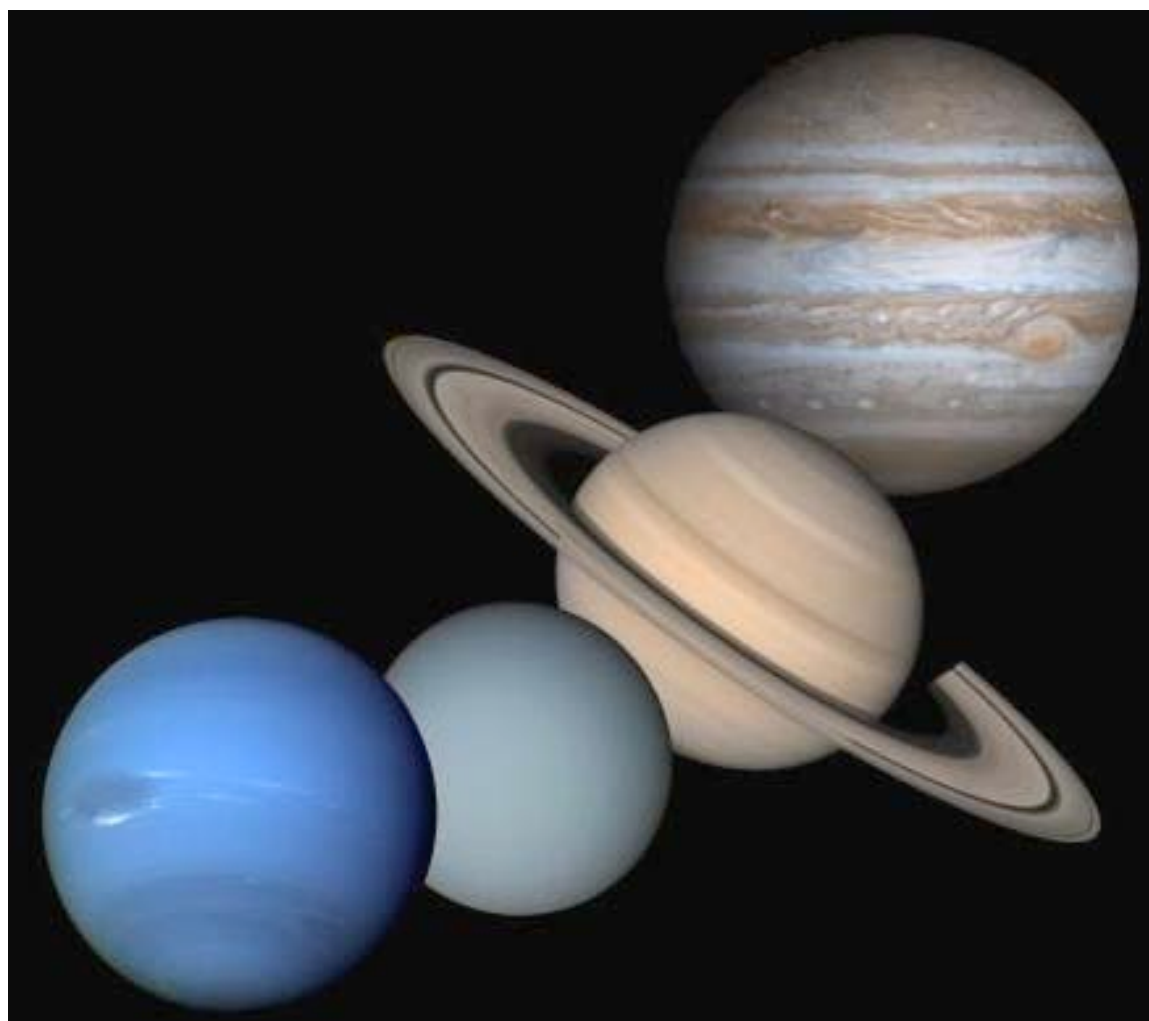

FIGURE 7.1 The giants planets—Neptune, Uranus, Saturn, and Jupiter—exhibit a diversity of properties and processes relevant to planetary science both in our local neighborhood of the Solar System and in planetary systems discovered around nearby stars. SOURCE: NASA; available at <http://www.astrophys-assist.com/educate/robot/page11.htm>.

TABLE 7.1 Major Accomplishments by Ground- and Space-based Studies of Giant Planets in the Past Decade

Major Accomplishment	Mission and/or Technique
The census of known exoplanets increased dramatically, from about 50 in 2000 to more than 500 in 2011, with an additional 1,200 candidates as of this writing ^a ; most of these are giants, with increasing evidence that ice-giant-sized planets are more abundant than Jupiters; first compositional measurements acquired; and complex multi-planet systems discovered.	Ground- and space-based telescopes
A spacecraft en route to Pluto observed Jupiter's polar lightning, the life cycle of fresh ammonia clouds, the velocity of extensive atmospheric waves, boulder-size clumps speeding through the planet's faint rings, and the path of charged particles in the previously unexplored length of the planet's long magnetic tail.	New Horizons
Discoveries at Saturn include confirmation of the hot southern polar vortex, deep lightning, large equatorial wind changes and seasonal effects, ring sources and shepherd moons, propeller-like ring structures as well as spokes and wakes, and the likely source of Saturn's kilometric radio emissions	Cassini
Uranus's equinox in 2007 was observed with modern instruments (last equinox was in 1965). Revealing unprecedented cloud activity with both bright and dark atmospheric features, two new brightly colored rings, and several new small moons.	Ground-based telescopes
Neptune's ring arcs shifted location and brightness in an unexplained fashion, and evidence emerged for a hot polar vortex on Neptune.	Ground-based telescopes
Three giant impacts on Jupiter have been recorded since June 2009; one of them was large enough to create a debris field the size of the Pacific Ocean; Jupiter also exhibited planet-wide cloud and color changes for the first time in two decades.	Ground-based telescopes

^a W. Borucki and the Kepler Team, Characteristics of planetary candidates observed by Kepler, II: Analysis of the first four months of data, submitted to *Astrophysical Journal*, arXiv:1102.0541 [astro-ph.EP], 2011.

Currently, Earth is the single known example of an inhabited world, and the solar system's giants hold clues to how Earth came to be. Bearing this in mind, we articulate three overarching goals for giant planet system exploration, each of which is discussed in more depth in subsequent sections.

- Giant planets as ground truth for exoplanets: Explore the processes and properties that influence giant planets in the solar system (including formation, orbital evolution, migration, composition, atmospheric structure, and environment), in order to characterize and understand the observable planets in other planetary systems.
- Giant planets role in promoting a habitable planetary system: Test the hypothesis that the existence, location, and migration of the giant planets in the solar system has contributed directly to the evolution of terrestrial planets in the habitable zone.
- Giant planets as laboratories for properties and processes on Earth: Establish the relevance of observable giant planet processes and activities, such as mesoscale waves, forced stratospheric oscillations, and vortex stability, as an aid to understanding similar processes and activities on Earth and other planets.

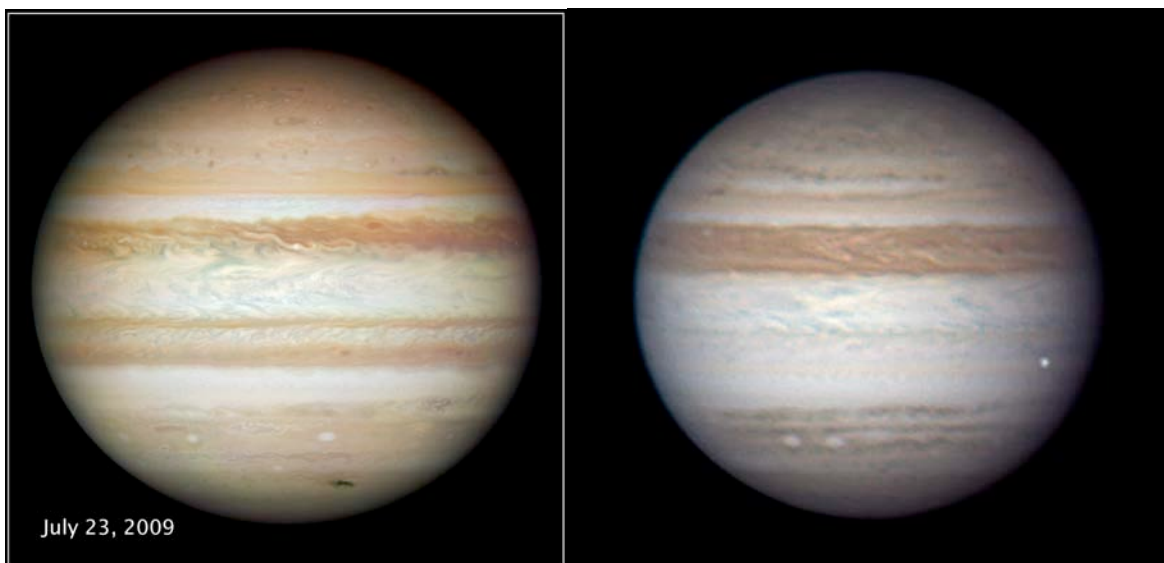

FIGURE 7.2 *Left:* This Hubble image of Jupiter shows the aftermath of an impact in 2009. The collision created a debris field the size of the Pacific Ocean (dark region on lower right), similar to the sites created by the impacts of the Shoemaker-Levy 9 fragments in 1994. *Right:* Yet another impact occurred on Jupiter in 2010, this time seen only during its fireball phase (bright spot on right edge of planet). Two different amateur astronomers captured the meteor on video, but the impact left no detectable trace in the atmosphere even in observations with the world’s most powerful telescopes, including Hubble and Gemini. SOURCE: *Left:* Courtesy NASA, ESA, M. H. Wong, H. B. Hammel, and the Hubble Impact Team. *Right:* Courtesy of Anthony Wesley.

GIANT PLANETS AS GROUND TRUTH FOR EXOPLANETS

As of this writing, our previous sample size of 4 giants (our “local” giants: Jupiter, Saturn, Uranus, and Neptune) has grown to include more than 520 planets orbiting other stars (“exoplanets” or “extra-solar planets”), with thousands of planet candidates waiting in the wings.⁴ Hundreds of these exoplanets are giants. Dozens reside in multi-planet systems, and their orbits range from circular to elliptical; some giants even exist in retrograde orbits.

Emerging evidence suggests a continuum in planet properties from massive Jupiters (easiest to find with most techniques) to Neptune-sized ice giants (or water worlds) and beyond to even smaller planets; an Earth-sized planet may be within our grasp during the period covered by this decadal survey.⁵ The results of planet searches via transits⁶ and microlensing⁷ suggest that ice giants, like Neptune and Uranus, are very common among exoplanets. Indeed, evidence is mounting that ice giants are at least three times more prevalent than gas giants beyond the planetary disk snow-line.⁸ The recent discovery of a planetary system with five Neptune-mass planets, as well as two others including one mass of about 1.4 times that of Earth, underscores this result.⁹

To date, transiting planets have been most amenable to further physical characterization, specifically through their positions on a mass-radius diagram. Prior to 1999, only solar system planets could be so plotted. As of this writing, more than 80 known transiting exoplanets have been added; the Kepler Mission has a candidate list numbering more than 300, and CoRoT also continues to find candidates. Such large numbers of objects enable correlations of mass with bulk composition in a statistical sense, opening a new window into processes of planet formation.

Giant planets in the Jupiter-mass range (100 to 300 Earth masses) are primarily composed of hydrogen and helium captured from nebulae that were present in the first few millions of years of planet

formation. Smaller planets such as Uranus and Neptune (about 15 Earth masses), or still smaller terrestrial planets, such as Earth, are depleted overall in light gases. Uranus and Neptune, although essentially water-dominated, retain deep hydrogen-helium envelopes that were likely captured from the Sun's early nebula.

Three confirmed transiting exoplanets similar to Uranus and Neptune have been discovered as of this writing, and many more are apparent in the Kepler mission early release data.¹⁰ More such objects will be discovered, permitting us to map out the efficiency of capture of nebular gas, planetary formation/migration processes, and variations in bulk composition with planetary mass. The science return on such statistical information is significantly enhanced by combining it with highly detailed data on the giant planets in the solar system, which can be visited by spacecraft and studied in situ via probes.

In the future, directly imaged planets around young stars will provide a wealth of new data. Key goals in studying exoplanets include: determining atmospheric and bulk composition variation with orbital distance, mass, and the properties of the primary star, as well as understanding the physical and chemical processes that affect atmospheric structure, both vertically and globally.¹¹

Our knowledge of solar system giants directly informs exoplanet studies, because we can study local giants with exquisite spatial resolution and sensitivity, as well as with in situ analyses by planetary probes. Thus, key goals in studying Jupiter, Saturn, Uranus, and Neptune mirror those stated above for exoplanets, with further examples including: studies of internal structure and evidence for cores; stratospheric heating mechanisms; the role of clouds in shaping reflected and emitted spectra; and the importance of photochemistry and non-equilibrium atmospheric chemistry. The extrapolation of the solar system's magnetospheres to those expected for exoplanets can also be addressed by gaining knowledge of comparative magnetospheres; these should include Earth and the four giant planets, and scaling relations should be determined between magnetospheric size, density, strength of interaction with the solar/stellar wind, and other properties. Most missions to the giant planets would be capable of contributing to answering these questions with the proper instrumentation. Our knowledge is most lacking for the ice giants. Objectives associated with the goal of using giant planets as ground truth for exoplanets include the following:

- Understand heat flow and radiation balance in giant planets,
- Investigate the chemistry of giant planet atmospheres,
- Probe the interiors of giant planets with planetary precession,
- Explore planetary extrema in the solar system's giant planets,
- Analyze the properties and processes in planetary magnetospheres, and
- Use ring systems as laboratories for planetary formation processes.

Subsequent sections examine each of these objectives in turn, identifies key questions to be addressed and future investigations and measurements that could provide answers.

Understand Heat Flow and Radiation Balance in Giant Planets

As giant planets age, they cool. A giant planet's atmosphere not only controls the rate at which heat can be lost from the deep interior, it responds dynamically and chemically as the entire planet cools. Atmospheric energy balance depends on the depth and manner in which incident solar energy is deposited and the processes by which internal heat is transported to the surface. Also, vertically propagating waves likely play a role in heating the upper atmospheres, since giant planet ionospheres are hotter than expected. This overall view of giant planet evolution has been well understood since the early 1970s and it seems to describe Jupiter's thermal evolution very well.

Saturn, however, is much warmer today than simple evolutionary models would predict. A "rain" of helium may be prolonging the planet's evolution, keeping it warmer for longer. As the helium droplets separate out and rain from megabar pressures, eventually redissolving at higher pressures and

temperatures, helium is enhanced in the very deep interior. A credible, complete understanding of the thermal evolution of Saturn cannot be claimed until the atmospheric helium abundance is known in Saturn and this mechanism can be tested. Saturn is exhibiting detectable seasonal variation (discussed further below), which is also linked to energy balance, but the driving causes are not well understood.

The evolution of Uranus and Neptune are likewise poorly understood, in part because knowledge of the energy balance of their atmospheres is very limited. Data from the Voyager 2 encounter with Neptune showed that the intrinsic global heat flow from Neptune's interior is about 10 times larger than radioactive heat production from a Neptune mass of chondritic material. Voyager 2 radiometric data of Uranus placed an upper limit on that planet's intrinsic heat flow that was about a factor of three lower than the Neptune value, about three times higher than the chondritic value.^{12,13} Determination of the actual Uranus heat flow value rather than an upper limit would greatly constrain interior structure via thermal history models, and clarify the difference in heat flow as compared with Saturn and Neptune. Of particular interest is whether composition gradients in the ice-giant mantles may be inhibiting cooling and influencing the morphology of the magnetic field. Hints of seasonal or solar-driven changes are emerging for the ice giants as well. More precise infrared and visual heat-balance studies of these planets would better constrain their thermal histories.

Outside of the solar system, our "standard" theory of giant planet cooling fails again, this time in explaining the radii of the transiting hot Jupiters. The radii of over 50 transiting planets have now been measured, and ~40 percent of these planets have radii larger than can be accommodated by standard cooling models. A better understanding of solar system giant planet evolution will inform our characterization and interpretation of the process of planetary evolution, leading us to a better understanding of why such a substantial number of exoplanets seem to be anomalous.

In addition to questions about the global heat flow and evolution of extrasolar giant planets, questions remain about the radiation balance and heating mechanisms within their detectable atmospheres. The *Spitzer Space Telescope* turned out to be extraordinarily adept at detecting atmospheric thermal inversions (hot stratospheres) on exoplanets, thus the study of exoplanet atmospheric thermal structure has received great attention. A variety of different mechanisms, including absorption by equilibrium and non-equilibrium chemical species, likely play a role in exoplanet stratospheric heating. A better understanding of solar system giant planet atmospheric chemistry and energy balance will illuminate our understanding of exoplanet processes as well.

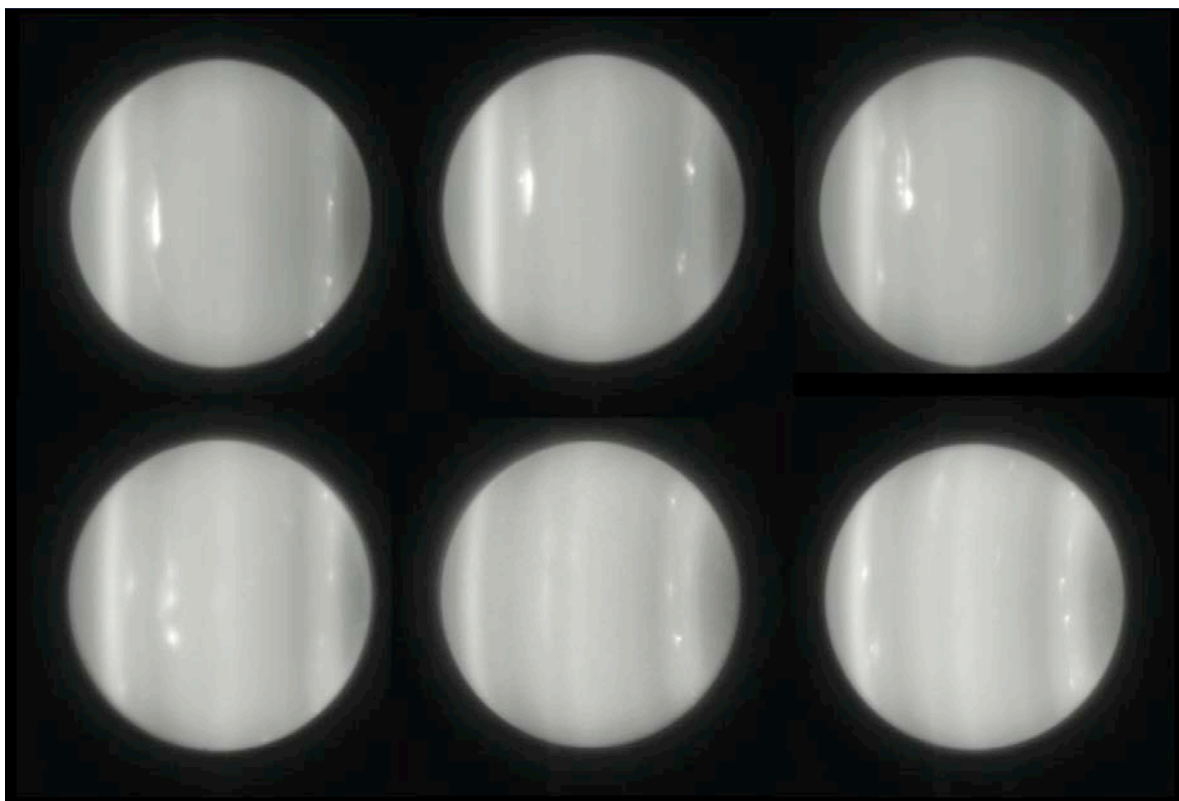

FIGURE 7.3 Uranus at equinox in 2007 reveals complex atmospheric detail in these images from the Keck 10-m telescope at 1.6 microns (Voyager camera's longest bandpass was 0.6 microns). Some Keck images contain more than three dozen discrete features, three times more than were seen in the entire Voyager Uranus encounter. These images were selected to show the rapidly evolving structure of one particular large cloud complex in the southern (leftmost) hemisphere. Images in the top row were obtained in 2007, the year of Uranus's equinox. The bottom row shows an image in 2008 (far left) and two images in 2009. Note the asymmetric banded pattern; ground-based photometric observations indicate this asymmetry is seasonally driven. SOURCE: Courtesy I. de Pater, L. Sromovsky, and H. Hammel.

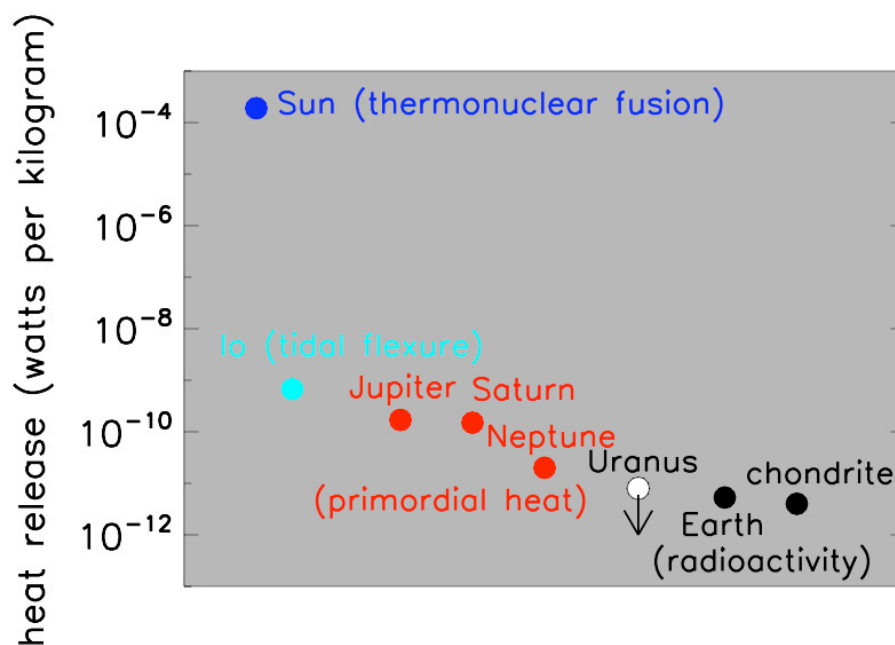

FIGURE 7.4 The intrinsic specific luminosities of some solar system objects are arrayed horizontally by predominant regimes of internal heat production at the present epoch. The Sun derives quasi-steady heating through thermonuclear fusion, while heating from tidal flexure is important in Io and possibly in some exoplanets. Jupiter, Saturn, and Neptune predominantly release primordial accretional heat. In Earth and other rocky objects of roughly chondritic composition, radioactive decay is important for heat production. SOURCE: Courtesy of William Hubbard, University of Arizona.

Important Questions

Some important questions associated with the objective of understanding heat flow and radiation balance in giant planets include the following:

- What is the energy budget and heat balance of the ice giants, and what role do water and moist convection play?
- What fraction of incident sunlight do Uranus and Neptune absorb and how much thermal energy do they emit?
- What is the source of energy for the hot coronas/upper atmospheres of all four giant planets?
- What mechanism has prolonged Saturn's thermal evolution?
- Does helium rain play a role in reducing the H/He in Saturn's molecular envelope?
- Why and how does the atmospheric temperature and cloud composition vary with depth and location on the planet?
- Which processes influence the atmospheric thermal profile, and how do these vary with location?

Future Directions for Investigations and Measurements

Inside the solar system, one of our two gas giant planets does not fit within the simple homogeneous picture of planetary cooling, and neither of our ice giants is well understood. Given the abundance of extra-solar ice giants, the internal structure and atmospheric composition of Uranus and Neptune are of particular interest for exoplanet science. For Uranus and Neptune, however, our understanding is very limited of their atmospheric thermal structures and the nature of their stratospheric heating, particularly compared to what is already known for Jupiter and Saturn. Atmospheric elemental and isotopic abundances are poorly constrained, and the abundances of N and O in the deep interior are unknown.¹⁴

The best approach to truly understand giant planet heat flow and radiation balance would be a systematic program to deliver orbiters with entry probes to all four giant planets in the solar system. The probes would determine the composition, cloud structures, and winds as a function of depth and location on each planet. They would be delivered by capable orbiting spacecraft that provide remote sensing of the cloud deck in visible light as well the near- and thermal-infrared regimes, and would yield detailed gravitational measurements to constrain planetary interior structure.¹⁵

The Galileo mission began this program at Jupiter. Indeed, Jupiter has been well studied by seven flyby missions, as well as by the Galileo spacecraft that spent almost 8 years in jovian orbit and delivered an in situ atmospheric probe. Jupiter is also the target of the Juno mission, the top priority of the Giant Planets Panel in the last decadal survey. Juno will constrain H₂O and possibly sense deep convective perturbations of the gravitational field. The Jupiter Europa Orbiter (JEO), NASA's contribution to the proposed NASA-ESA Europa Jupiter System Mission might provide some confirmation of thermal and visible albedo measurements taken by Cassini and from Earth depending on final instrumentation. However, the selected orbit of JEO and the need to protect the craft will yield only limited information to supplement Juno's determination of gravitational moments and the nature of the inner magnetic field. Jupiter is our best-studied and best-understood analog for exoplanet formation. Further jovian studies would benefit most by the development of a more complete scientific understanding of the other giant planets, for which far less is known.¹⁶

A Saturn probe coupled with Cassini data (remote sensing and gravitational information from its final phase) can test the He differentiation hypothesis through measurement of the He abundance. Such a measurement by a Saturn entry probe would resolve a decades-old, fundamental question in solar system science. The probe would also provide atmospheric elemental and isotopic abundances, including methane abundances. Such measurements address formation history and help to better constrain atmospheric opacity for gas giant evolutionary modeling.¹⁷

An ice giant entry probe will likewise measure atmospheric elemental and isotopic abundances—hence probing formation mechanisms—and again measure methane abundances and thermal profiles necessary for ice giant evolutionary modeling. An ice-giant orbiter—providing high-precision bolometric and Bond-albedo measurements, phase functions, and mid- and far-infrared thermal luminosity—will provide significant advances in understanding energy balance in ice giant atmospheres. An orbiter with ultraviolet capability can address the issue of the hot corona by observing the altitudinal extent of the upper atmosphere. A mission combining an orbiter and a probe will revolutionize our understanding of ice giant properties and processes, yielding significant insight into their evolutionary history.

Throughout the next decade, research and analysis support should be provided to interpret spacecraft results from the gas giants and to continue ongoing thermal and albedo observations of the ice giants. The latter is of particular importance because of the excruciatingly long time between spacecraft visits: this necessitates regular observations from state-of-the-art Earth-based facilities to provide long-term context for the short-duration spacecraft encounters.¹⁸

Investigate the Chemistry of Giant Planet Atmospheres

To help connect the solar system's giant planets to those around other stars and to appreciate the constraints internal and atmospheric composition place on planetary interior and formation models, we need to better understand the chemistry of the "local" giants Jupiter, Saturn, Uranus, and Neptune. Giant planets by definition have a major mass component derived from the gaseous nebula that was present during the planetary system's first several million years, the same nebula from which Earth formed. This major component, primarily hydrogen and hydrides plus helium and other noble gases, offers the possibility of remote and in situ access to sensitive diagnostics of processes that governed the early nebular phase of solar system evolution. At the same time this mass, and its chemistry, can be modified by interactions with the environment and the host star.

More than 15 years ago, the Galileo entry probe provided the only in situ measurements of a giant planet to date. Prior to the probe's measurements, it had been generally expected that the heavier noble gases (argon, krypton, and xenon) would be present in solar abundances, as all were expected to accrete with hydrogen during the gravitational capture of nebular gases. The probe made a surprising discovery: Ar, Kr, and Xe appear to be significantly more abundant in the jovian atmosphere than in the Sun, at enhancements generally comparable to what was seen for chemically active volatiles such as N, C, and S. Neon, in contrast, was depleted; recent studies have implicated helium-neon rain as an active mechanism for Jupiter to explain the depletion of neon detected by the Galileo probe.¹⁹

Various theories have attempted to explain the unexpected probe results for Ar, Kr, and Xe. Their enhanced abundances require that these noble gases were separated from hydrogen in either the solar nebula or Jupiter's interior. One way this could be done would be by condensation onto nebular grains and planetesimals at very low temperatures, probably no higher than 25 K.²⁰ Such a scenario would seem to require that much or most of Jupiter's core mass accreted from these very cold objects, otherwise the less volatile N, C, and S would be significantly more abundant than Ar, Kr, and Xe. Other pathways towards the enhancement of the heavy noble gases have also been postulated. The noble gases could have been supplied to Jupiter and Saturn via clathrate hydrates.^{21,22} An alternative theory²³ suggests that jovian abundance ratios are due to the relatively late formation of the giant planets in a partially evaporated disk. A completely different possibility is that Jupiter's interior excludes the heavier noble gases, sulfur, nitrogen, and carbon more or less equally, so that in a sense Jupiter would have an outgassed atmosphere.

These theories each make specific, testable predictions for the abundances of the noble gases. The only way to address noble gas abundances in giant planets is by in situ measurements (abundances of N, C, and S can be measured remotely using optically active molecules such as NH₃, CH₄, and H₂S). A Saturn probe provides an excellent test of the competing possibilities. For instance, the clathrate hydrate hypothesis²⁴ uses a solar nebula model to predict that Xe is enhanced on Saturn due to its condensation, whereas Ar and Kr are not since they would need lower temperatures to condense. The cold condensate hypothesis²⁵, in contrast, predicts that Ar and Kr, as well as Xe, would be more than twice as abundant in Saturn, based on evidence that carbon in Saturn is more than twice as abundant as it is in Jupiter. Discrimination among various models will profoundly influence our understanding of solar nebular evolution and planet formation.

Some Important Questions

Some important questions concerning the chemistry of giant planet atmospheres include the following:

- How did the giant planet atmospheres form and evolve to their present state?
- What are the current pressure-temperature profiles for these planets?
- What is the atmospheric composition of the ice giants?

Future Directions for Investigations and Measurements

Accurate and direct determination of the relative abundances of hydrogen, helium and other noble gases, and their isotopes, in the atmospheres of Saturn and the ice giants is a high priority objective that directly addresses fundamental processes of nebular evolution and giant-planet origin. This objective is best addressed by in situ measurements from a shallow (up to ~ 10 bar) entry probe. An in situ probe is the only means of definitively measuring the pressure-temperature profile below the 1-bar level.²⁶

To understand the fundamentals of atmospheric radiation balance in ice-giant atmospheres, a mission is required that can provide high-spatial observations of zonal flow, thermal emission, and atmospheric structure. An ice-giant orbiter can best achieve these observations.

Probe the Interiors of Giant Planets with Planetary Precession

Interior dynamic processes directly affect heat transport and distribution of interior electrical conductivity, yet cannot be directly observed (magnetospheres are discussed in more detail below). However, precise measurements of high-order structure (and possible time variation) of giant planet gravity fields can yield important constraints on these processes. Such measurements may also elucidate the degree of internal differentiation (i.e., presence or absence of a high-density core), related to the planets' mode of formation and subsequent thermal history. Orbiter-based measurements of planetary pole position and gravity anomalies can now be carried out to precisions exceeding 1 part in 10^7 . When combined with temporal baselines over years to decades, such observations bring geophysical data on the solar system's giant planets into a realm comparable to that of the terrestrial planets, furnishing detailed "ground truth" for the much cruder observations of exoplanets.

Important Questions

Some important questions concerning probing the interiors of giant planets with planetary precession include the following:

- What are the pole precession rates for giant planets?
- How much do they constrain models of the internal structure of the giant planets?

Future Directions for Investigations and Measurements

Determining the internal structure of Jupiter is a key measurement objective for Juno. The Cassini orbiter mission to Saturn has finished the "Equinox" mission, and has started the "Solstice" Mission. Together, the Juno mission and the end-of-life plans for Cassini will address, for Jupiter and Saturn, much of the precision geophysical measurements advocated above. A single measurement with the year-long Juno orbiter mission is unlikely to provide adequate constraints, but could ultimately be combined with measurements from other epochs to yield the jovian angular momentum and hence a model-independent value for the jovian axial moment of inertia.

Explore Planetary Extrema

Solar system giant planets provide valuable planet-scale laboratories that are relevant to understanding important physical processes that are found elsewhere in the solar system and in exoplanetary systems. One example is the balance between incident solar flux and internal heat flux. Hot

Jupiters seen around other stars inhabit a regime where the internal heat flux is trivial compared to the huge incident flux. Young Jupiter-mass planets at large separation from their stars, such as the three planets imaged around the star HR 8799,²⁷ inhabit the opposite extreme where incident flux is trivial compared to the internal heat flow. Intriguingly, the internal heat flow of Uranus also is at best a tiny fraction of the incident flux while at Jupiter the two energy fluxes are comparable. The large obliquity of Uranus, which imposes extreme seasonal changes, further makes this ice giant an excellent test subject for studying planetary extrema. Understanding how planets respond to such extremes, both in terms of thermal structure and global dynamic state, is thus invaluable to understanding exoplanets. Indeed the same general circulation models of atmospheric winds that are used to study solar system giants have also been applied to the transiting exoplanets. Contributions to our understanding will come from a better knowledge of both the internal heat flow of Uranus and Neptune and their atmospheric dynamics and winds as a function of altitude and latitude.²⁸

Another example is the radii of many extrasolar planets, which are much larger than expected on the basis of traditional planetary structure models. One explanation for this anomaly is that as the planet migrates and its orbit becomes more circularized, tidal dissipation in the interior of the giant provides a heat pulse, prolonging the evolution of the planet.²⁹ The efficiency and thus viability of this mechanism hinges on the ratio of energy stored to energy dissipated (the so-called tidal “Q” factor) of the planet.

A final example of a local extremum is the transient, highly shocked conditions achieved during the impact of an object into Jupiter’s atmosphere. We now understand that such impacts are not rare, having witnessed both the Shoemaker-Levy 9 impacts in 1994,³⁰ and the subsequent impacts in 2009³¹ and 2010.³² Studying the dark impact debris (highly shocked jovian “air” that has reached temperatures of thousands of degrees) helps test models of jovian thermochemistry that are used to model the atmospheres of the hot Jupiters.³³ Ground and space-based observations of the aftermath of such impacts provide data on the pyrolytic products created in the impact event.

Important Questions

Some important questions concerning planetary extrema include the following:

- How do giant planets respond to extreme heat balance scenarios, both in terms of thermal structure and global dynamic state?
- How is energy dissipated within giant planets?

Future Directions for Investigations and Measurements

Studies of the interior structures of solar system giants help to constrain the internal energy dissipation. For Jupiter, Juno will attempt to measure jovian tidal bulges produced by Io and Europa, measurements that will provide new data on Jupiter’s interior. Direct measurement of Jupiter’s tidal “Q” factor (energy dissipation) from the corresponding tidal phase lags would require considerably more precision than Juno gravity data can deliver, but high-precision measurements of Galilean satellite orbits (perhaps from JEO) might be able to detect associated secular changes in orbital periods and thus constrain the tidal “Q” factor.

A Neptune or Uranus orbiter will provide better knowledge of the internal heat flow of an ice giant, as well as critically needed information about ice-giant atmospheric dynamics and winds as a function of altitude and latitude.

Analyze the Properties and Processes in Planetary Magnetospheres

Giant exoplanets orbiting close to their parent stars exist in an extreme regime of physical conditions. They are expected to have much stronger interactions with the stellar winds than Jupiter or Earth; in fact detecting exoplanets through their auroral emissions has often been discussed.^{34,35} The four giant planets and Earth provide us with an understanding of the basic physics and scaling laws of the interactions with a stellar wind needed to understand exoplanets. Exoplanet internal magnetic field strengths are unknown, but can be roughly estimated if the planet rotation rate equals its orbital period due to tidal torques. Exoplanets' hot atmospheres may well extend beyond the magnetopause and be subject to rapid loss in the stellar wind, important for estimating the lifetime of these objects.

The interaction of an exoplanet magnetosphere with its host star could take many forms. A Venus-like interaction with rapid mass loss from the top of the atmosphere could result if the planet's internal magnetic field is weak. An Earth-like auroral interaction could result if the internal field is stronger, or a Jupiter-like interaction if the planet is rapidly rotating and its magnetosphere contains a large internal source of plasma. A much stronger star-planet interaction could result if the star's rotation rate is rapid compared with the planet's orbital period: the planet's motion through the star's magnetic field would generate a large electric potential across the planet, driving a strong current between the planet and the star. This could result in a "starspot," analogous to a sunspot. Observations of starspots may be a promising approach for remotely sensing the electrodynamic interaction of exoplanets with their stars.

The giant planets in our solar system have strong magnetic fields and giant magnetospheres, leading to solar wind interactions quite different from what is seen at Earth. The size scales are much larger and the time scales are much longer, still the aurora on both Jupiter and Saturn are affected by changes in the solar wind. Unlike Earth, Jupiter's magnetosphere and aurora are dominated by internal sources of plasma, and the primary energy source is the planet's rotation. Saturn is an intermediate case between Earth and Jupiter: it has a large, rapidly rotating magnetosphere with internal sources of plasma, yet the aurora and nonthermal radio emissions consistently brighten when a solar wind shock front arrives at the planet. The ice giants have substantially tilted magnetospheres that are significantly offset from the planets' centers, configurations that differ completely from those of Jupiter and Saturn.

Understanding of the magnetospheric environments of Jupiter and Saturn has deepened since the last decadal survey. The Galileo mission at Jupiter has concluded. Cassini passed Jupiter, entered orbit around Saturn, and successfully completed its nominal mission. NASA's Infrared Telescope Facility has obtained infrared images of Saturn's aurorae. A large Hubble observing program to observe the ultraviolet auroral emissions from Jupiter and Saturn has been conducted that—coupled with New Horizons measurements at Jupiter and Cassini measurements at Saturn—has shown the extent of solar wind control over giant planet aurora. There have been no comparable missions to Uranus or Neptune, however, thus knowledge of ice-giant magnetospheres is limited to data from Voyager 2 flybys more than two decades ago, supplemented by subsequent scant Earth-based observations. The scarcity of close-range measurements of ice giants has seriously limited the advance of our knowledge of their magnetospheres and plasma environments. New measurements from Uranus and/or Neptune therefore have a high priority in the outer planet magnetospheres community.

Some Important Questions

Some important questions concerning the properties and processes in planetary magnetospheres include the following:

- What is the nature of the displaced and tilted magnetospheres of Uranus and Neptune, and how do conditions vary with the pronounced seasonal changes on each planet?
- What is the detailed plasma composition in any of these systems, particularly for ice giants?

- What causes the enormous differences in the ion to neutral ratios in these systems?
- What can our understanding of the giant planet magnetospheres tell us about the conditions to be expected at extra-solar giant planets?

Future Directions for Investigations and Measurements

Despite concentrated observations of Jupiter and Saturn both in situ and from Earth-based facilities, there remain many unanswered questions. These can be addressed in part by JEO measurements in its initial orbital phase, including observations of auroral emission distribution and associated properties from close polar orbital passes, as well as of upper atmosphere energetics.³⁶

Nearly nothing is known about the magnetic fields and magnetospheres of Uranus and Neptune aside from the brief Voyager encounters more than two decades ago. Either a flyby spacecraft or an orbiter could address some aspects of ice giant magnetospheric science, but an orbiter would tremendously advance our understanding of ice giant magnetospheres.³⁷

Extrapolation of the solar system's magnetospheres to those expected for exoplanets can be addressed by gaining knowledge of comparative magnetospheres; these should include Earth and the four giant planets, and scaling relations should be determined between magnetospheric size, density, strength of interaction with the solar/stellar wind, and other parameters. Most giant planet missions could contribute to answering these questions; our knowledge is most lacking for the ice giants.

Use Ring Systems as Laboratories for Planetary Formation Processes

Investigations of planetary rings can be closely linked to studies of circumstellar disks. Planetary rings are accessible analogues in which general disk processes such as accretion, gap formation, self-gravity wakes, spiral waves, and angular momentum transfer with embedded masses can be studied in detail. The highest priority rings recommendation of the last decadal survey³⁸ was accomplished: to operate and extend the Cassini orbiter mission at Saturn.^{39,40} Progress has also come from Earth-based observational and theoretical work as recommended by the last decadal survey and others.^{41,42}

Saturn's Ring System

Cassini data, supported by numerical and theoretical models, have revealed a wealth of dynamical structures in Saturn's rings, including textures in the main rings produced by inter-particle interactions and patterns generated by perturbations from distant and embedded satellites. Its observations of the orbits of embedded "propeller" moons in Saturn's rings reveal surprisingly robust orbital evolution on approximately one-year timescales, possibly due to gravitational or collisional interactions with the disk.⁴³ Collective inter-particle interactions produce phenomena including what are now termed "self-gravity wakes" (elongated, kilometer-scale structures formed by a constant process of clumping counter-balanced by tidal shearing), radial oscillations in the denser parts of the rings that may be due to viscous overstability, and "straw-like" textures seen in regions of intense collisional packing such as strong density waves and confined ring edge.

Moons embedded within the rings are observed to produce gaps, though the origins of many other gaps remain unknown. In Saturn's F ring, Cassini images show evidence for active accretion triggered by close approaches of the nearby moon Prometheus,⁴⁴ while recent accretion is inferred for other known ring moons.^{45,46,47} Data from Cassini's spectrometers and other instruments are elucidating the composition and thermal properties of the icy particles in Saturn's rings, as well as the characteristics of the regolith covering larger ring particles. These properties vary subtly between different regions of the rings, for reasons that are currently not understood.

The evident processes and properties of Saturn's ring system provide essential clues as to how all rings and other disks of material behave (including circumstellar disks and proto-planetary disks). Non-gravitational forces, including electromagnetism, drive the evolution of dusty rings such as Saturn's E ring (as well as Jupiter's gossamer rings and probably Uranus's dusty "zeta" ring), but much work is still needed to clarify the processes involved. Cassini will continue tracking the orbits of "propeller" structures through the end of its Solstice Mission in 2017. The direct detection of orbital migration remains a major goal for Cassini in the Solstice Mission, either for nearby moons interacting gravitationally with the rings or for the embedded and unseen "propeller" moonlets. Cassini will also make further observations of the ring micro-structure. Cassini results also have focused renewed attention on the origin and age of Saturn's rings: the realization that the B ring may be much more massive than previously thought has the potential to ease a primary constraint on the rings' age, namely pollution by interplanetary mass infall; a continuing goal of Cassini is to measure that flux.

Other Ring Systems

The most remarkable features of Neptune's rings are the azimuthally confined arcs embedded in the Adams ring. Although a resonance mechanism has been proposed for the confinement of these arcs, post-Voyager observations at Keck have cast at least the details of this model into doubt.⁴⁸ The same observations also reveal that the arcs are evolving on timescales as short as decades, consistent with our emerging perspective of the dynamic nature of diffuse rings. Further close-range observations of both the rings and their associated arcs will be necessary to resolve the outstanding questions regarding their nature, origin and persistence.

The uranian ring system is massive, complex, and diverse, and much about it remains poorly understood. It includes several narrow and sharp-edged dense rings whose confinement mechanism remains unclear. The 2007 equinox of Uranus provided an unprecedented opportunity to study its ring system. During the edge-on apparition (which last occurred in 1965), two new diffuse Uranian rings were discovered in Hubble images in 2005.⁴⁹ They appear eerily similar to Saturn's E and G rings in color and planetocentric distance,⁵⁰ but have yet to be characterized in any detail. Equinoctial Keck observations of Uranus also detected the diffuse dusty inner "zeta" ring for the first time since the 1986 Voyager flyby, and revealed it has changed substantially since then.⁵¹ The reason for this change is unknown; temporal effects of Uranus's extreme seasons on the rings may be contributing factors.

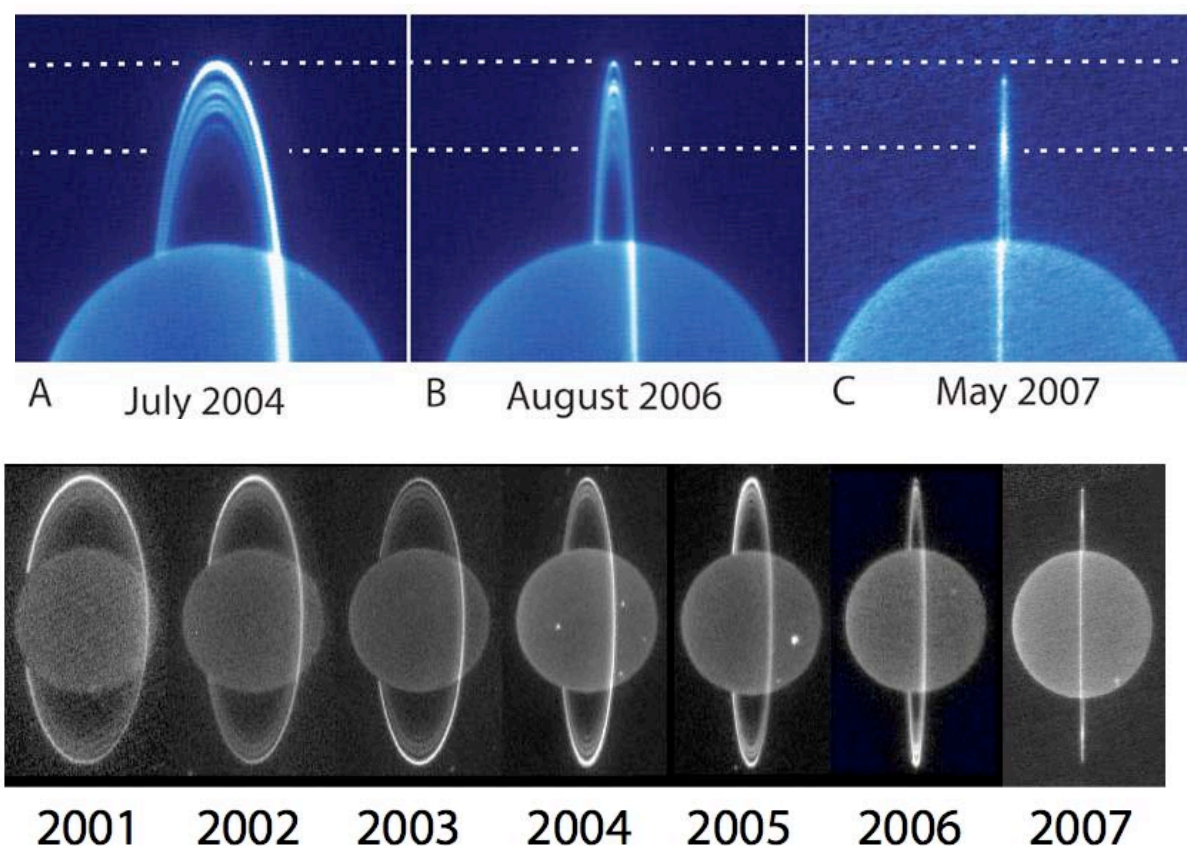

FIGURE 7.5 *Top*: This composite compares the optically thick rings, such as the epsilon (upper line), and optically thin rings, such as the zeta (lower line), at different viewing angles. *Bottom*: Images from the Keck 10-m telescope shows the changing aspect of Uranus as it approached the 2007 equinox, as well as the improving quality of Keck’s adaptive optics (AO) system as it was tuned for Uranus. At this wavelength (2.2 microns) methane absorption darkens the planet except for discrete cloud features reaching altitudes high enough to be above the bulk of the methane. SOURCE: *Top*: Courtesy of Imke de Pater (UC Berkeley), Heidi B. Hammel (SSI, Boulder), and the W.M. Keck Observatory. *Bottom*: From I. de Pater, H.B. Hammel, M.R. Showalter, and M.A. van Dam, The dark side of the rings of Uranus, *Science* 317(5846):1888-1890, 2007. Reprinted with permission from AAAS.

Important Questions

Some important questions concerning ring systems as laboratories for planetary formation processes include the following:

- What can the significant differences among ring systems teach us about the differing origins, histories, or current states of these giant planet systems?
- Can the highly structured forms of the Uranus and Neptune ring systems be maintained for billions of years, or are they “young”? Are their dark surfaces an extreme example of space weathering?
- What drives orbital evolution of embedded moonlets; how do they interact with their disks?
- What drives mass accretion in a ring system?

Future Directions for Investigations and Measurements

The chemical and physical properties of uranian and neptunian ring particles remain almost completely unknown, beyond the former's very low albedo. Observing the rings of Uranus and Neptune at close range in the near infrared would considerably enhance our understanding of their origin and composition. Observations at high phase angles inaccessible from Earth are the key to estimating particle sizes. Ground-based observations have detected changes in the rings of Neptune and the diffuse rings of Uranus on decadal timescales or shorter; Cassini likewise saw significant structural changes in Saturn's D and F rings on similar timescales. The mechanisms behind these changes remain mysterious, and it is highly desirable to study these changing structures in detail. Therefore, orbiter missions to Uranus and/or Neptune represent the highest priority for furthering ring science in the next decade.⁵²

The recent New Horizons flyby has demonstrated the value of continued observations of Jupiter's rings, revealing a new structure that still is not fully understood. Missions to Jupiter, as well as any mission encountering Jupiter en route to another target, should observe this poorly characterized ring system as opportunities allow.⁵³

The Cassini Solstice mission will continue to yield significant ring science, as articulated above. In future decades, a dedicated Saturn Ring Observer could potentially obtain "in situ" Saturn-ring data with unprecedented spatial resolution and temporal coverage. Initial engineering studies for such a mission exist, but further technology development is required during the next decade to develop a robust mission profile.⁵⁴

Nearly all constituent ring particles are too small to observe individually, even from an orbiting spacecraft, so a proper interpretation of any observations requires an understanding of their collective effects and behavior. Thus, for example, theoretical and numerical analyses of ring dynamics are essential to interpreting the photometry of Saturn's rings as observed by Cassini and from Earth-based telescopes. Laboratory studies of potential ring-forming materials also are needed to understand ring spectroscopy.⁵⁵

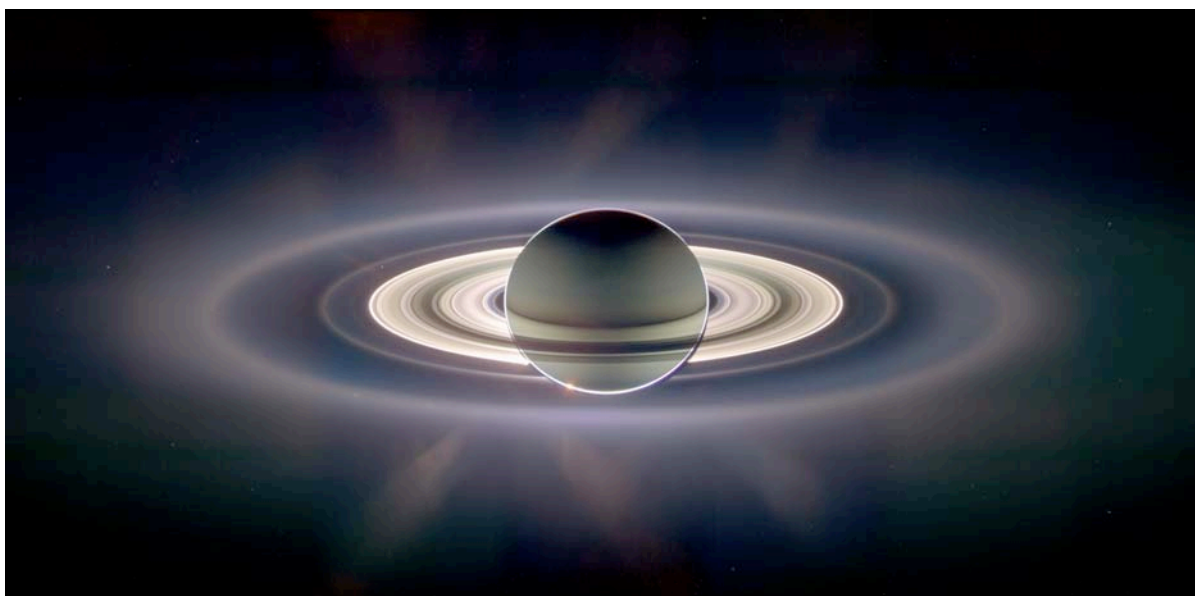

FIGURE 7.6 In this image of Saturn taken by the Cassini spacecraft of the Saturn system backlit by the Sun, tiny Earth glints through the magnificent ring system at about the 10 o'clock position. SOURCE: NASA/JPL/Space Science Institute.

EXPLORING THE GIANT PLANET'S ROLES IN PROMOTING A HABITABLE PLANETARY SYSTEM

The solar system contains myriad objects—small and large—orbiting the Sun, and these bodies can directly affect the habitability of Earth. For example, large planetary impacts are an ongoing process, not merely a historical fact. Observations of Jupiter make this very clear; witness the spectacular impact of D/Shoemaker-Levy 9 with Jupiter in 1994. The effects of the jovian collisions prompted studies of, and surveys for, potentially hazardous asteroids in near-Earth space. The surprising second collision of a body with Jupiter in 2009, followed by two more jovian impacts in 2010, underscores the hazards in the interplanetary environment.

The Sun itself is highly variable, with potentially significant consequences. The explosive release of stored magnetic energy in the Sun's atmosphere leads to extremely large solar “storms,” causing changes in emitted electromagnetic radiation at all energies, ejecting energetic particles, and enhancing the solar wind at Earth. The most prominent examples of their manifestations include not only natural spectacles such as auroral displays, but also direct impacts on human activities such as catastrophic failures of electrical grids and spacecraft hardware. The aurorae of the Jupiter and Saturn provide important data points in understanding the propagation of these storms across the solar system. Understanding these solar eruptions, and their propagation to Earth and beyond, plays an important role in contemporary solar physics and has generated its own field of space weather.

By studying the giant planets in the context of processes that occur throughout the solar system, we gain a deeper understanding of how those processes play out here on Earth. This is illustrated with specific examples about energy balance, interactions with the Sun's magnetic field, and how the surfaces in giant planet systems are “weathered.”

Specific objectives associated with the goal of exploring the giant planets' role in crafting a habitable planetary system include the following:

- Search for chemical evidence of planetary migration;
- Explore the giant planets' role in creating our habitable Earth via large impacts; and
- Determine the role of surface modification via smaller impacts.

Subsequent sections examine each of these objectives in turn, identifies important questions to be addressed and future investigations and measurements that could provide answers.

Search for Chemical Evidence of Planetary Migration

In the past, various models have been proposed for formation of planetary systems in general and specifically for the solar system. All these models made basic assumptions concerning condensation of planet-forming components and the manner in which they were accumulated by the planets. In the last two decades, increased computing power has led to rejection of some models and increased support for a model in which Jupiter and Saturn interacted to perturb the planets into their current configuration. The degree to which the planets were formed by collisional impacts of volatile-bearing bodies or collapse of gases onto larger bodies should have left behind evidence that can be found within the compositional makeup of the surviving bodies. Thus, determination of the chemical composition (D/H, other isotopic abundances, noble gases, water) will discriminate among models that will constrain initial conditions and illuminate how the planets have evolved.

The distribution of the heavy elements (atomic mass >4) as a function of distance from the Sun can provide strong constraints for discriminating among theories and dynamical models of solar system formation and evolution. One of the predictions of the models is that the central core mass of the giant planets should increase with distance from the Sun. This should result in a corresponding increase in the abundances of the heavier elements. Currently the only element measured for all four planets is carbon,

increasing from three- times solar at Jupiter to about 30-times solar at Neptune. In order to discriminate among formation models, abundances are needed for the heavy elements (nitrogen, sulfur, oxygen, and phosphorus), helium and the other noble gases and their isotopes, and isotope ratios of hydrogen, helium, nitrogen, oxygen, and carbon.

Although the isotopic information is limited, modeling efforts have produced divergent theories of the formation of the solar system. Models that placed the formations of Uranus and Neptune at their current positions were unable to produce adequate ice-giant cores before the proto-nebula dissipated. Faced with this stumbling block, dynamic modelers have been led to conclude that the outer planets have significantly changed their orbital positions since their original formation. The “Nice model”—the currently accepted standard solar system formation scenario—proposes that during the first several hundred million years after the formation of the planets Neptune was less than 20 AU from the Sun.^{56,57} As the orbits evolved Saturn and Jupiter entered a 2:1 mean motion resonance and the resulting perturbation to Saturn’s eccentricity drove the orbits of Uranus and Neptune outward, leading to the current configuration of giant planets.

Many variations of the dynamical formation scenario have been proposed.^{58,59,60,61,62,63} Other approaches to the birth of the solar system address the manner in which the heavy elements were delivered to the giant planets, as discussed earlier. To help distinguish among these theories or to generate others, we require in situ measurements of heavy element abundances and isotopic ratios in the well-mixed atmospheres of the giant planets.

Some Important Questions

Some important questions concerning chemical evidence of planetary migration include the following:

- How and why do elemental and isotopic abundances vary as a function of distance from the Sun?
- How and why do the abundances of the heavy elements and their isotopes, the D/H ratio, the H/He ratio and noble gases differ between the two classes of giant planets represented in the solar system?

Future Directions for Investigations and Measurements

Shallow entry probes (<10 bars at Saturn) will enable determination of the abundances for most of the required species. The elemental abundances and isotopic information gained from the shallow probes will provide major constraints for the plethora of solar system formation models and a guide to extend models to exoplanetary systems. To reach deep below the water cloud on Saturn and determine the water abundance in a well-mixed region would be desirable, but far more technically challenging.⁶⁴

Coupling a probe with an orbiter, particularly for one of the relatively unexplored ice giants, will substantially advance giant planet science. An orbiter could provide the global distribution of disequilibrium species and ortho/para hydrogen ratios via infrared remote sensing with high frequency resolution. This would yield a framework for interpreting the in situ elemental and isotopic probe results.⁶⁵

Explore the Giant Planets’ Role in Creating a Habitable Earth via Large Impacts

On average, 1-kilometer or larger diameter comets and asteroids impact Earth about once every hundred thousand years. Impacts of this size and larger yield major tsunamis if an ocean is struck and can

destroy areas of land equivalent to moderate sized states. Larger impacts, like the Cretaceous/Tertiary impactor 65 million years ago, can dramatically affect life over the entire surface of Earth. Although the impactor hazard to life on Earth is not negligible, it is less than might otherwise be the case without the giant planets. Around one million asteroids are believed to be larger than 1 kilometer and there are likely far more comets of this size and larger. All of these objects represent potential Earth impactors.

The solar system's giant planets, particularly Jupiter, exert a major influence on the orbits of such objects. Asteroids or comets on elliptical orbits that would bring them to the inner solar system must cross the orbit of Jupiter. Close encounters with Jupiter can dramatically alter a potentially dangerous body's orbit, possibly sending it out of the solar system. While in some cases Jupiter might cause an otherwise harmless object to take a dangerous turn, some n-body simulations suggest that in other cases Jupiter protects Earth.⁶⁶

The number and timing of jovian impacts provides insight into the rate at which Jupiter deflects small bodies. Each impact delivers species to Jupiter's stratosphere that would not be produced by internal jovian processes; a better inventory of jovian stratospheric composition along with improved atmospheric models and numerical models of asteroid and comet orbits would constrain impact history.

More importantly, these events serve as laboratories for the physics of large airbursts. We now have an open, unclassified source of Earth bolide observational data, but these are for relatively small events. Those who have studied the subject of Earth impacts estimate intervals of hundreds of years between events the size of the Tunguska impact in Siberia in 1908. Yet as of this writing, astronomers have observed four such impact events on Jupiter in the past 16 years (counting the demise of D/Shoemaker-Levy 9 in 1994 as "one" event). By understanding the physics of large airbursts, better estimates their threat to Earth can be made.

Important Questions

Some important questions concerning the giant planets' role in creating a habitable Earth via large impacts include the following:

- What is the current impact rate on Jupiter?
- To what extent can Jupiter's current atmospheric composition be utilized as a record of the impact history?
- What are the characteristics of bolides and large airbursts on Jupiter, and how do they compare with known bolides and airbursts on Earth?

Future Directions for Investigations and Measurements

The best approach to determining the rate and characteristics of jovian atmospheric impacts is continuous observation of Jupiter. Today, such work relies on a small number of highly motivated amateur observers; these unfunded volunteer observers, however, cannot cover Jupiter at all times. Small, automated, planetary monitoring telescopes could provide a comprehensive survey of future impacts on Jupiter, perhaps as a National Science Foundation project. The Large Synoptic Survey Telescope (LSST) or other survey telescopes may also provide observational constraints on moving objects that could be on Jupiter impact trajectories.⁶⁷

Determine the Role of Surface Modification via Smaller Impacts

A number of important external processes govern the size, structure and dynamics of the giant planets, their ring systems and their satellites (in addition to the obvious role of solar illumination). Many

of these processes are analogous to those that operate on terrestrial planets and in the Earth-Moon system. Impacts by km-sized asteroidal and/or cometary objects have long been recognized as a dominant process in sculpting the surfaces of most bodies in the solar system.

Less obvious and much less understood is the role played by smaller impactors, down to dust-size, in modifying the surface composition and texture. Examples in the outer solar system include: the neutral-colored material that darkens the C Ring and Cassini Division at Saturn,⁶⁸ and the dark material which coats the leading side of Iapetus, thought to be derived from Phoebe or the other outer satellites.⁶⁹ More speculative are the long-term effects on the structure and lifetime of outer planet ring systems due to ring-particle collisions and collisions of external impactors.

Important Questions

Some important questions concerning the role of surface modification via smaller impacts include the following:

- What are the flux, size distribution, and chemical composition of the various populations of impactors, from late-stage planetesimals 4 billion years ago to present-day interplanetary dust?
- What are the surface modification mechanisms for low-temperature smaller icy targets?

Future Directions for Investigations and Measurements

More sophisticated dust detectors carried by spacecraft such as Galileo, Ulysses and Cassini have already refined—and in some cases revolutionized—knowledge of interplanetary dust, and much more remains to be learned here. Near-infrared spectral studies of the Galilean and saturnian moons and rings have led to new models for dust “contamination” of icy surfaces, but definitive identification of the chemical species involved remains elusive and may require in situ sampling. Near-infrared spectral studies of the rings and small moons in the ice-giant systems are needed to fully characterize the differences of the dust populations in the more distant regions of the solar system.⁷⁰

GIANT PLANETS AS LABORATORIES FOR PROPERTIES AND PROCESSES ON EARTH

The planet that matters most to humankind is Earth. The planet’s health and ecologic stability are of paramount importance to us all. Earth, however, is a notoriously difficult planet to understand. The atmosphere interacts in a complex fashion with the lithosphere, hydrosphere, cryosphere, and biosphere (surfaces that are, respectively, rocky, liquid, icy, or biologically active). Yet knowledge of this interplay is critical for understanding the processes that determine conditions of habitability within the thin veneer of Earth’s surface.

Giant planets, though larger than Earth, are in many respects simpler than Earth. The physics and chemistry driving the processes in their thick outer atmospheres can be understood without reference to a lithosphere, cryosphere, hydrosphere, or biosphere. The processes in giant-planet ring systems at times resemble pure examples of Keplerian physics, with added interactions from collisions, resonances and self-gravity. In a very real sense, the giant planets and their environs can serve as laboratories for the fundamental physical processes that affect all planetary atmospheres and surfaces.

To work effectively in our planetary laboratory, we must understand our tools, and we must frame proper experiments. Fundamental objectives associated with the goal of using the giant planets as laboratories for properties and processes of direct relevance to Earth include the following:

- Investigate atmospheric dynamical processes in the giant planet laboratory,

- Assess tidal evolution within giant planet systems,
- Elucidate seasonal change on giant planets, and
- Evaluate solar wind and magnetic field interactions with planets.

Subsequent sections examine each of these objectives in turn, identifies critical questions to be addressed and future investigations and measurements that could provide answers.

Investigate Atmospheric Dynamical Processes in the Giant Planet Laboratory

On the giant planets, jet streams dominate the atmospheric layers accessible for remote-sensing and in situ measurements. Visible and infrared data generated with spacecraft (e.g., Voyager, Galileo, Cassini, New Horizons) and large Earth- and space-based telescopes (e.g., Hubble Space Telescope, Keck, Gemini, the Very Large Telescope) established two distinct regimes of atmospheric circulation: Jupiter and Saturn show strong eastward equatorial jets and alternating poleward east-west jets, while Uranus and Neptune display westward equatorial winds and broad mid-latitude prograde jets. These results, in conjunction with the inferred bulk composition differences, imply that distinct giant planet regimes are represented within the solar system: gas giants (90 percent hydrogen by mass) with deep-seated convective regions, and ice giants (bulk compositions are dominated by heavier elements) that support a structure where water becomes a supercritical fluid with depth. Studies of both types of planets, to sample a range of obliquities, insolation values, and internal heat flow values, are needed to untangle the role of each forcing mechanism.

Within the atmospheres of the gas giants, the jets blow in the east-west (i.e., zonal) directions. Alongside the jet streams, vortices large and small pepper the visible layers; some appear as textbook fluid dynamics turbulent features, which are also seen on Earth. The steady existence of large-scale atmospheric features combined with infrequent close-range spacecraft observations and long seasonal cycles of the outer planets have given the general impression that the giant planets are static.

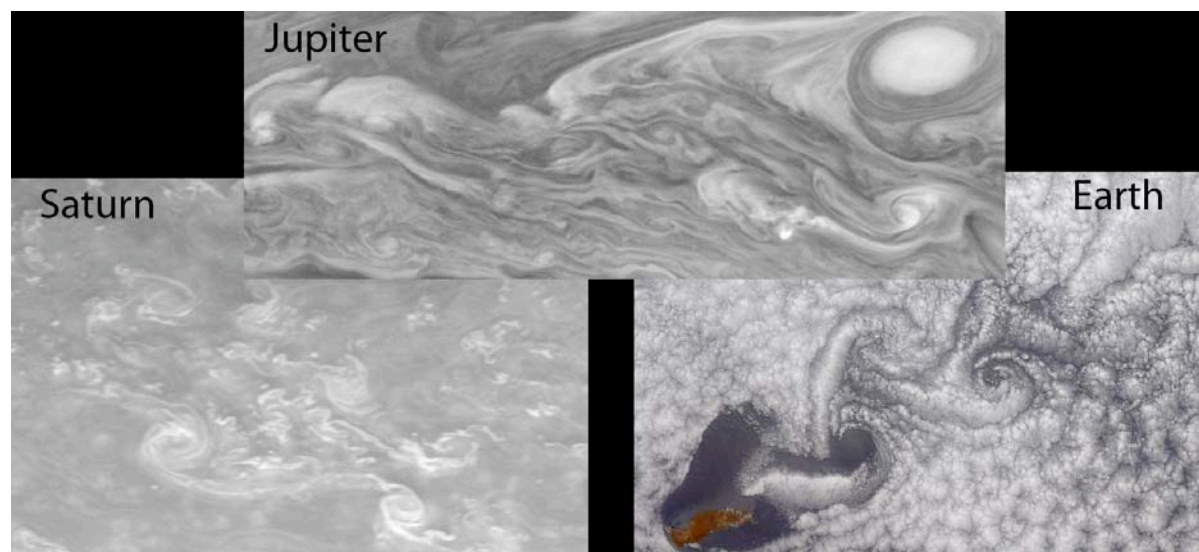

FIGURE 7.7 Turbulent phenomena are a common feature of planetary atmospheres. These images of Jupiter, Saturn, and Earth (from Galileo, Cassini, and Landsat 7 respectively) show similar Kármán vortex streets (i.e., a repeating pattern of swirling vortices) forming downstream from a disturbance; such phenomena are scale independent. SOURCE: Composite by Amy Simon-Miller NASA Goddard Space Flight Center. *Jupiter*: NASA/JPL; *Saturn*: NASA/JPL/Space Science Institute; *Earth*: NASA/GSFC/JPL, MISR Team.

Long temporal-baseline data and ever-improving observational capabilities prove that these worlds are as dynamic as Earth. In the past decade, Jupiter has gone through a global upheaval, during which the colors of the clouds changed in multiple zonal bands associated with the jet streams. On Saturn, Cassini and Hubble measurements in 2003 showed that the equatorial jet at the cloud level has slowed compared with the winds seen during the Voyager flybys in 1980-1981.⁷¹ A long-term campaign by the NASA Infrared Telescope Facility, combined with Cassini data, has revealed a new stratospheric temperature oscillation on Saturn analogous to those on Jupiter, Earth and Mars.^{72,73}

A new generation of ground-based telescopes armed with adaptive optics (including Keck, Gemini and Subaru) have enabled discoveries of many dynamic cloud features on Uranus and Neptune, revealing the changing seasons on these slowly orbiting planets; these facilities have also revealed that Saturn, Uranus, and Neptune have hot poles,^{74,75,76} while Jupiter's poles have never been imaged (Jupiter's rotation axis has little tilt, making Earth-based observations difficult; missions that have flown by or orbited Jupiter have stayed near the equatorial plane). Together, these new observations show that the giant planet atmospheres are dynamic and evolving.

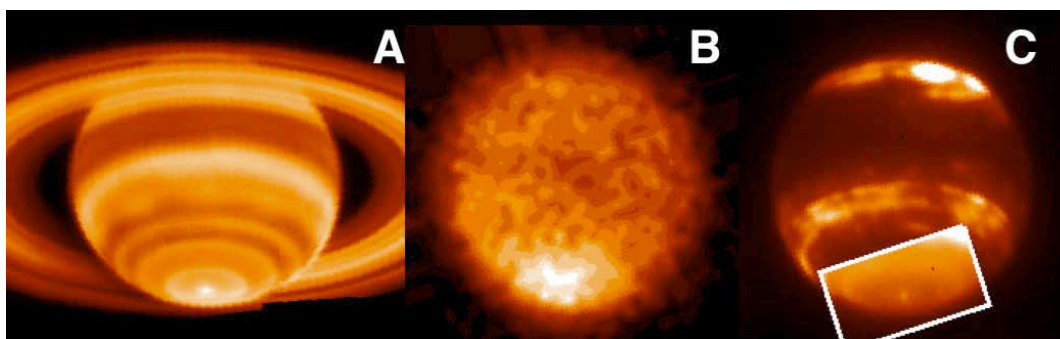

FIGURE 7.8 Saturn and Neptune both show evidence for dynamical activity and “hot” poles. Saturn at $8.0\ \mu\text{m}$ (A) shows strong methane emission from its southern pole. Neptune at $7.7\ \mu\text{m}$ (B) also shows methane emission from the south polar region in this image from the Gemini North telescope. A simultaneous image at $1.6\ \mu\text{m}$ taken with adaptive-optics imaging at the Keck 2 telescope (C) shows that Neptune's zonal circulation is as tightly confined in the polar region as that of Saturn. SOURCE: H.B. Hammel, M.L. Sitko, D.K. Lynch, G.S. Orton, R.W. Russell, T.R. Geballe, and I. de Pater, Distribution of Ethane and Methane Emission on Neptune, *Astronomical Journal* 134:637-641, 2007.

The Galileo probe set limits on critical isotopic abundances in Jupiter's atmosphere and revealed zonal winds increasing with depth and we are beginning to understand the nature of the wind fields and vortices. Yet our knowledge for gas giants is not complete: we need in situ measurements of Saturn's winds. Uranus and Neptune are even less well understood: due to the scarcity of observational data, the lifecycles of large and small vortices are unknown; and the temporal dynamics of the zonal winds, as well as their horizontal and vertical structures, have not been examined. Unlike the case of Earth, for these planets we do not have true three-dimensional information at high spatial resolution over reasonable time scales to allow for full comparison with laboratory and theoretical models.

Important Questions

Some important questions concerning atmospheric dynamical processes in the giant planets include the following:

- What processes drive the visible atmospheric flow and how do they couple to the interior structure and deep circulation?
- What are the sources of vertically propagating waves that drive upper atmosphere oscillations and do they play a role on all planets?
- Are there similar processes on Uranus and Neptune, and how do all these compare with Earth's own stratospheric wind, temperature and related abundance (ozone, water) variations?
- How does moist convection shape tropospheric stratification?
- What are the natures of periodic outbursts such as the global upheaval on Jupiter and the infrequent great white spots on Saturn?

Future Directions for Investigations and Measurements

To answer these, we must resolve the three-dimensional structure of the atmospheric flow fields with high spatial and temporal resolution, including polar regions. The vertical motions in the troposphere involve the fast, localized, motions caused by moist convection and the slow, global, overturning meridional circulation caused by the predicted (Hadley-like) belt-zone convection cells.

Determining atmospheric motion and coupling includes the study of atmospheric waves, and the stratospheric responses to the wave forcing (oscillations); such waves may have a chemical signature. The stratospheric oscillations that have been discovered on Earth, Mars, Jupiter and Saturn provide a rare stage for conducting comparative planetological investigation between terrestrial and giant planets. It may also be possible to detect similar oscillations on Uranus and Neptune.

Finally, there is a need to explore polar phenomena. Jupiter's poles exhibit numerous small vortices, and, to date, their zonal mean flow structure has not been observed in detail. Saturn's north pole has a circumpolar jet that meanders in a hexagonal shape, while the south pole has a hurricane-like structure with a well defined eye-wall. Little is known about the polar regions of Uranus and Neptune.

Some of the above atmospheric objectives may be addressed by Juno and JEO for Jupiter, and to some extent by Cassini for Saturn. Significant advances on Jupiter by JEO would require long temporal observations, adequate spatial resolution on Jupiter, and relevant instrumentation. For Uranus or Neptune, these atmospheric objectives are poorly constrained by Earth-based data. An orbiter would be optimal for investigating such phenomena. Significant theoretical and modeling research should also be supported to infer the atmospheric structures underlying the observed layers and to advance the understanding of shear instabilities.⁷⁷

Juno may achieve measurements of gravitational signatures of deep zonal flows for Jupiter, and the Cassini mission may do likewise for Saturn during its final proximal orbits. This will reveal the basic structure of the deep flow driven by internal convection, and yield information about the internal heat transport. Juno and Cassini should place useful limits on the higher-order moments of the internal magnetic fields and potentially detect some temporal evolution (i.e., secular variation). For an ice giant, a flyby could moderately improve our understanding, while an orbiter with a low periapse approach would greatly advance the scientific understanding of the interiors and magnetic fields of the ice giants.⁷⁸

Assess Tidal Evolution Within Giant Planet Systems

A ubiquitous example of an external process within planet systems is the tide raised on a planet by an inner satellite, and the resulting transfer of angular momentum from the planet's spin to the orbit of the moon (or vice versa in the case of retrograde or sub-synchronous satellites such as Triton and Phobos). Such tidal torques are thought to have established the orbital architectures of the inner satellite systems of Jupiter, Saturn and Uranus—including their numerous orbital resonances—as well as the current states of the Earth-Moon and Pluto-Charon systems. Tides raised by giant planets on their satellites, in concert with eccentricities driven by orbital resonances, are responsible for significant

heating in Io, and probably also in Europa and Enceladus. Although the theory of tidal evolution is well known, the precise nature and level of tidal energy dissipation within jovian planets (which in turn determines the timescale for tidal evolution) is much less certain: estimates range over many orders of magnitude for Jupiter.

Important Questions

Some important questions concerning tidal evolution within giant planet systems are as follows:

- How far have the various satellites evolved outwards from their sites of formation?
- To what extent do the observed eccentricities and inclinations of satellites reflect this evolution?

Future Directions for Investigations and Measurements

Advances in understanding of tidal influences on the Moon and Mars have come from our ability to track surface landers, either with laser ranging or Doppler tracking. Accurate measurements of satellite orbital evolution offer the only realistic avenue to measure the dissipation rates inside the giant planets, e.g., by the accurate tracking of multiple spacecraft flybys (Cassini at Titan) or satellite orbiters (the proposed JEO).⁷⁹ Recent work suggests that direct detection of orbital expansion for the inner jovian moons may be possible with spacecraft imagery spanning many decades, e.g., from Voyager to JEO.⁸⁰ The inner moons at Uranus and Neptune may offer similar opportunities for orbiters at these planets.

Elucidate Seasonal Change on Giant Planets

Seasonal variation of Earth's atmosphere is well understood; the extent to which seasonal change impacts the atmospheres of the giant planets is a field of intense speculation. Observations at any one epoch cannot be interpreted properly if long-term variability is not understood. In the last decade, ongoing interpretation of the Galileo and HST data has provided constraints for dynamical models of Jupiter.⁸¹ Juno promises to supply additional constraints concerning the jovian water abundance and global distribution that was not obtained with the Galileo probe.

Saturn's zonal flow exhibits detectable variation that may be seasonal in nature.^{82,83,84} We are also beginning to understand the effects of ring shadow on insolation and atmospheric response, an added complication for Saturn.⁸⁵ Infrared imaging with Cassini (VIMS) has revealed that under the overlying high cloud cover the Saturnian atmosphere is highly convective and latitudinally constrained. The extension of the Cassini mission to summer solstice in the northern hemisphere provides an opportunity for detailed observations of Saturn. Similar deep wind and composition information is needed for Saturn, however, which requires an atmospheric probe.

Understanding how seasonal changes are driven on ice giants as opposed to gas giants is necessary for a fuller understanding of weather and climate processes. With no flight missions to Uranus or Neptune since 1989, progress in understanding them has been challenging, and is exacerbated by the extreme observational requirements presented by these distant cold bodies: high spatial resolution, moving target tracking, and (particularly in the molecular-rich infrared regime) high sensitivity.

During the >20 years since the last flyby of an ice giant, we have built databases with long-enough timelines to begin to study seasonal change on the giant planets (the years on Saturn, Uranus and Neptune are ~29, 84, and 165 terrestrial years, respectively). Both spatial resolution and sensitivity necessitate the use of the best (and therefore most difficult to acquire) telescopic resources: Hubble and Keck. No other facilities, e.g., VLT and Gemini, have the capability to produce comparable high-

resolution visible and near-infrared imaging on these objects with their current laser guide-star adaptive optics capability; furthermore, Hubble's lifetime is now limited. Using Hubble and Keck (supplemented by Gemini, VLT, and Subaru in the mid infrared, the VLA at radio wavelengths, and lower-resolution observations from Lowell Observatory, the NASA IRTF, and other facilities), seasonal changes are beginning to emerge on Uranus and Neptune^{86,87,88} and we are beginning to glean insight on the lifetime and behavior of large and medium-scale atmospheric features.^{89,90,91} Yet some of the most basic physical properties of these ice giant planets remain unknown, and planetary missions are the only means of uncovering those properties.

Important Question

One important question among many relating to seasonal change on giant planets is:

- How do variations in insolation and temperature (i.e., heat balance) drive changes in dynamics and composition?

Future Directions for Investigations and Measurements

A systematic effort is desired that would deliver multiple entry probes to all four planets to determine the composition and cloud structure and winds as a function of depth and location on the planet. A capable orbiting spacecraft would deliver these probes, and would also provide remote sensing of the cloud deck in infrared and visible light, as well as detailed gravitational measurements to constrain the interior structure. However, the cost of such an approach is prohibitive.⁹²

More realistically, the next logical steps for significant progress in giant planet studies are a Saturn probe and an orbiting mission with probe to Uranus or Neptune. For Jupiter, a second shallow probe is unlikely to further refine our understanding, and the Juno mission (constraining water and possibly sensing deep convective perturbations on the gravitational field) will continue to return new Jupiter data.⁹³

At the same time, research and analysis support will allow the interpretation of Cassini Saturn results and allows for ongoing studies of weather and climate on the ice giants. More precise infrared and visual heat-balance studies of all of these planets would better constrain their thermal histories. Some, but not all, of this work can be done with Earth-based facilities.

Evaluate Solar Wind and Magnetic Field Interactions with Planets

For comparison with Earth, the giant planets are the only solar system examples of planets with strong internal magnetic fields interacting with the solar wind. The dimensions of most planetary magnetospheres are set by a competition between solar wind ram pressure and the energy density in the planet's own magnetic field. Many of the observed phenomena in the outer regions of a magnetosphere are controlled, in part, by interactions with the solar wind. This includes the spectacular auroral displays seen near the magnetic poles of Earth, Jupiter, and Saturn, which are fed by magnetospheric plasma. In the case of Earth, most of the magnetospheric plasma is actually derived from trapped solar wind, but at Jupiter and Saturn the main sources appear to be Io and either the rings or the icy satellites (especially Enceladus).

At Earth these interactions have important consequences for human civilization. Strong currents can flow through the ionosphere in response to solar wind-induced storms in the magnetosphere, resulting in disruptions in both power distribution networks on the ground and satellite communications in space (including cell phones and GPS). These storms generally occur when shock fronts in the solar wind

arrive at Earth, often generated by coronal mass ejections (CME's), and the detailed forecasting of these events is the subject of the NSF-funded Center for Integrated Space weather Modeling (CISM). Understanding the interactions at all planets aids our understanding of physical processes at Earth. Solar system objects furthermore provide our only opportunity to make in situ measurements of plasma processes. Such processes are important in all areas of astrophysics;⁹⁴ solar system plasma observations thus play a role in shaping our ideas about hosts of other cosmic systems.

In addition to the global magnetospheres, “space weathering” is the collection of physical processes that erode and chemically modify surfaces directly exposed to the space environment, either the solar wind or a planetary magnetosphere. Understanding space-weathering effects is critical to the correct interpretation of surface observations from remote-sensing and in situ studies. Space weathering exposure results in a thin patina of material that covers and sometimes obscures the endogenic surface materials that are often the principal interest of remote-sensing observations. Space weathering also encompasses surface-removal processes such as sputtering by energetic particles, micrometeoroid erosion and photon-stimulated desorption; a less well-recognized (but potentially important) process is electron-stimulated desorption. These processes may be more important for planetary rings than they are for icy satellites, where they can result in relatively short lifetimes for dusty rings such as those at Jupiter and Uranus. The chemical products of space weathering could also affect subsurface processes on small satellites. Finally, irradiation can affect the electrostatic and magnetic environment of airless bodies through the build-up of static charge. The effect of the build-up of charged dust on the Mars rover solar panels is well known; whether or not such effects are important on small icy satellite surfaces or in ring systems is unknown.

Important Questions

Some important questions concerning solar wind and magnetic field interactions with planets include the following:

- How do magnetospheres interact with the solar wind?
- How is surface material modified exogenically (e.g., processes such as magnetospheric interactions and impacts) versus being pristine or relatively unmodified?

Future Directions for Investigations and Measurements

For all planetary magnetospheres from Earth to the outer solar system, in situ measurements of local magnetic fields and plasma environments should be combined with remote observations of the global magnetosphere. Local measurements should include both fields and particles to clearly determine the local density, currents, and large scale flows. Global measurements may be a combination of auroral imaging and spectroscopy (Earth-orbital ultraviolet and/or groundbased infrared measurements), observations of nonthermal radio emissions, and measurements of energetic neutral atoms. In situ measurements require missions to the planets. Remote observations can be provided from Earth or other vantage points, for example, a spacecraft en route to Neptune or Uranus could observe Jupiter and Saturn. In all cases, however sufficient time coverage is essential for complete context. Space weathering processes are interdisciplinary and “universal” in nature, requiring grounding in laboratory and theoretical studies, as well as simulation facilities.

INTERCONNECTIONS

Links to Other Parts of the Solar System

Comparative planetary studies offer great potential to improve our understanding of planetary systems in general. Knowledge gained about any of the terrestrial planets helps us to understand the origin and evolution of Earth-like planets in general. In the same vein, missions to the giant planets will help us to understand the basic physical properties of gas and ice giant planets as a class. In terms of the origin and evolution of the giant planet systems, learning about the planets, their satellites, and even other regions of the outer solar system (Kuiper belt objects, plutoids, comets, etc.) all help us to understand how conditions began and evolved over the lifetime of the solar system. Several aspects of giant planet science have connections to terrestrial planets, including but not limited to polar vortices, stratospheric oscillations, effects of planetary migration and volatile delivery, and the physics of large airbursts.

Links to Heliophysics

The giant planets are the only solar system examples, besides Earth, of planets with strong internal magnetic fields interacting with the solar wind. Many of the observed phenomena in the outer regions of a magnetosphere—including the auroral displays seen near the magnetic poles of Earth, Jupiter, and Saturn—are controlled in part by interactions with the solar wind. In the case of Earth, most of the magnetospheric plasma is actually derived from trapped solar wind, but at Jupiter and Saturn the main sources appear to be, respectively, Io and either the rings or the icy satellites (especially Enceladus). At Earth, these interactions have important consequences for human civilization (e.g., disruption in power distribution networks and satellite communications). Understanding the interactions of the solar wind at all of the planets aids understanding of the physical processes at Earth.

Links to Extrasolar Planets

The rapidly expanding fields of exoplanets and protoplanetary disks—fueled by data from space observatories as well as ground-based facilities—bring a wealth of new ideas regarding the processes that build and shape planetary systems. The majority of exoplanets discovered to date are giant planets, though the field is rapidly evolving as the Kepler, CoRoT, and other missions study hundreds of candidate objects.⁹⁵ Current studies of the atmospheres and magnetospheres of the giant planets are increasingly performed with an eye toward the application to extrasolar giant planets. It is critically important to understand the basic physics of the giant planets in the solar system if we are to understand the >500 exoplanets that have been discovered around nearby stars, for which there is a small fraction of the data that we have about the local giants Jupiter, Saturn, Uranus, and Neptune.⁹⁶

Giant planet atmospheres exhibit both super- and sub-rotation with respect to their cores, but the driving mechanisms are not fully understood. If we cannot understand the origin and physics of atmospheric dynamics in the local giants' atmospheres and clouds, our predictions for the circulation from dayside to nightside in an extrasolar giant that is phase-locked to its star will be of limited robustness. Understanding thermal balance and tidal effects are critical to understanding the evolution of extrasolar giant planet atmospheres and orbits.

Remarkably, thermal profiles for many exoplanets have been measured, and hot stratospheres have been found to be ubiquitous. If we do not understand the energy sources of the hot stratospheres and coronal upper atmospheres of the local giant planets (and we do not), we will not be able to predict the conditions in the upper atmosphere of a jovian planet at an orbital distance less than that of Mercury from its star. This is critical for understanding the rapid escape into space of the atmospheres of extrasolar

giants that approach too close to their host stars; such escape may set a limit to the minimum distance of a giant with a given mass (and hence gravity) from its host star.

The local giants all exhibit strong magnetic fields from dynamo action in their fluid interiors; the magnetic fields of Uranus and Neptune are offset and tilted in manners that have not been explained, and the physical origin and variability of their dynamos are not well understood. If we do not understand the basic principles of the local giants' magnetic fields and plasma environments, we cannot predict the strength and orientation of the magnetic fields of extrasolar giants, which may be phase-locked with their host stars, nor can we know how they will interact with the expected strong stellar winds. This interaction is critical to the coupling of the star and planet and could potentially dominate mass loss from the planet as well as the rotational dynamics of the planet/star interaction.

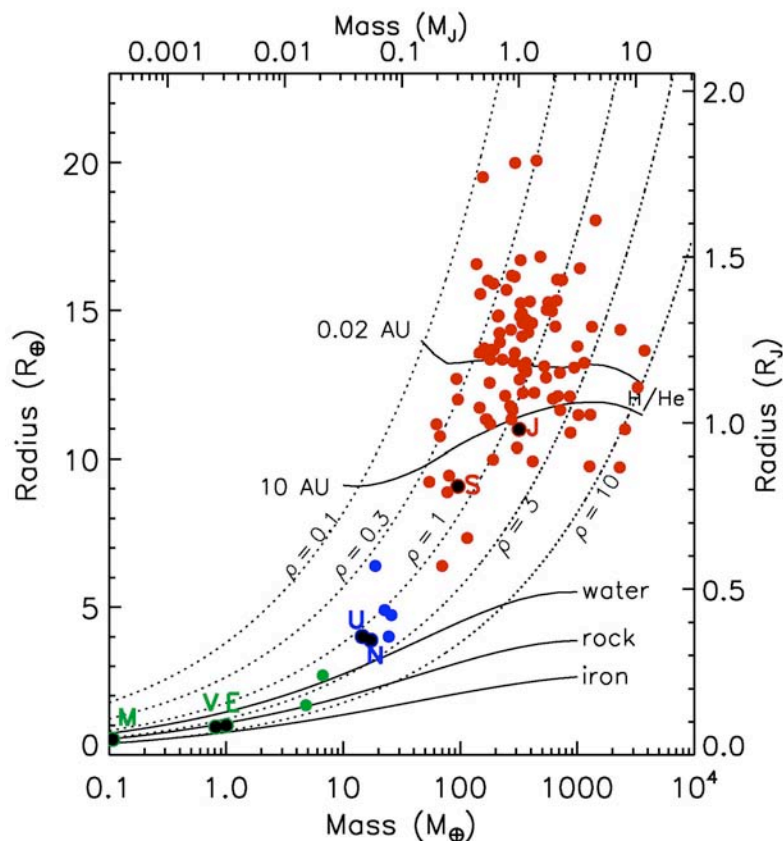

FIGURE 7.9 Planets now fill a continuum of sizes and distances from their host stars. In this mass-radius (MR) diagram, seven Solar System planets (black circles with letters; M = Mars) are compared with transiting exoplanets: gas-giant exoplanets (red circles); ice-giant exoplanets (blue circles) and super-Earths (green circles). The three lower lines are theoretical MR relations for super-Earths lacking a hydrogen-helium envelope, but with three differing solid compositions (water-, silicate-, and iron-dominated). The lines denoted “H/He” in the cluster of giants mark the radius expected for coreless giant planets with an assumed age of 4.5 Ga at the indicated distance from their stars. Many objects, termed “inflated” giants, lie much higher than those lines, indicating we do not yet understand giant planet evolution under severe stellar insolation. The solar system’s gas giants Jupiter and Saturn have been studied in some detail; our ice giants Uranus and Neptune are less well understood. SOURCE: Courtesy of Jonathan Fortney, University of California, Santa Cruz.

SUPPORTING RESEARCH AND RELATED ACTIVITIES

Research and Analysis

Progress in giant planet studies must be made on multiple fronts to understand the numerous intertwined processes operating inside these dynamic and complex systems. The specific examples discussed in this chapter are representative of just a subset of research and analysis efforts focused on giant planets. A single space mission lasts for a short duration of time compared to the long orbital periods of the outer planets, and studying the processes with longer timescales require research programs with long-term vision. Robust research and analysis programs, coupled with ground-based observations of giant planets and their attendant rings and moons, provide the foundation that links missions separated by decades.⁹⁷

INSTRUMENTATION AND INFRASTRUCTURE

Technology Development

The challenges common to all giant planet missions—large distances, long flight times, and stringent limitations on mass, power, and data rate—mean that all missions can benefit technical advances in a number of broad areas. The breadth of technology needed for giant planet exploration calls for an aggressive and focused technology development strategy. Specific technologies needed to enable future missions to the giant planets include: power sources; thermal protection systems for atmospheric probes; aerocapture and/or nuclear electric propulsion; and robust deep-space communications capabilities.⁹⁸

Instrumentation

Low mass and low-power electronics, as well as high-resolution and high-sensitivity instruments, are necessary in many applications including ground-based instrumentation; support that is directed to instrument programs that support these areas of development will be particularly beneficial.

Some of the most important advances in outer planet research have come from access to facilities such as Gemini and the National Optical Astronomy Observatory, as well as access to the Keck telescopes, through the NSF Telescope System Instrumentation Program (TSIP) program. TSIP provides funding to develop new instruments to enhance the scientific capability of telescopes operated by private (non-federally funded) observatories, in exchange for public access to those facilities. For example, much of the Uranus Ring-Plane Crossing observational work was supported at Keck via NOAO/TSIP time.

Earth- and Space-Based Telescopes

The Hubble Space Telescope has been crucial for giant planet research, especially high-resolution imaging of the ice giants. The study of auroral activity on the gas giants has been accomplished almost completely with Hubble's ultraviolet capability. There is no ultraviolet-optical high-resolution alternative from the ground, and thus Hubble observations remain a high priority for giant planet research through the mission's remaining lifetime.⁹⁹

The James Webb Space Telescope (JWST) is an infrared-optimized telescope to be placed at the second Sun-Earth Lagrange point. Non-sidereal (moving target) tracking requirements have been identified and are currently being implemented. JWST's science working group is assessing the feasibility of observing Jupiter and Saturn, which may require restricting wavelengths or using subarrays;

observations of Uranus and Neptune are planned, as are observations of their satellites and ring systems.¹⁰⁰

The NASA 3-meter Infrared Telescope Facility (IRTF) is a major facility in giant planet research: providing support observations for spacecraft missions; and producing original science data for research on a variety of giant planet areas from the near infrared through the thermal infrared. The IRTF sponsors a visitor equipment program that provides unique capabilities and wavelength coverage outside of the scope of the facility instruments, as well as training for new students in instrumentation.¹⁰¹

Telescopes of the >8-meter-class are crucial for observations of giant planets. Large-aperture observations coupled with adaptive optics (AO) systems provide the only means of obtaining adequate spatial resolution needed for the detailed evolution of atmospheric features, for example. In particular, Keck 2's AO system has been optimized for the extended planetary sources Uranus and Neptune, as well as Io, Titan, and Pluto. Laser-guide-star AO may someday allow other telescopes to rival Keck's image quality. Since this is not a viable option to date, however, NASA time at Keck is critical for proper planning of future space missions to these targets. The Large Synoptic Survey Telescope (LSST), with its wide-field and synoptic capabilities, may provide observational constraints on objects in the vicinity of the giants, particularly for objects that may be on Jupiter impact trajectories.

With apertures of 30 meters and larger, future extremely large telescopes (ELTs) will play a significant role in outer planet research. A key advantage of ELTs is spatial resolution in the mid-infrared and longer wavelengths, which is mandated by the diffraction limit; even 8- to 10-meter telescopes have difficulty with the small angular sizes of Uranus and Neptune. Observations using a 30-meter telescope could resolve thermal emission from Neptune with comparable resolution as the 3-meter IRTF can for Saturn.

At the other end of the facility-size spectrum, small amateur telescopes play an increasing role in laying groundwork for professionals. The 2009 and 2010 Jupiter impacts were discovered by amateurs, and within hours of each event, telescopes around the world were mobilized to follow up. Likewise, monitoring of Uranus and Neptune for anomalous cloud activity is solidly within the amateur purview. NSF could play a role in supporting amateurs with a modest investment in, for example, equipment or filter sets; this would enhance the current synergy with the professional outer-planet community.¹⁰²

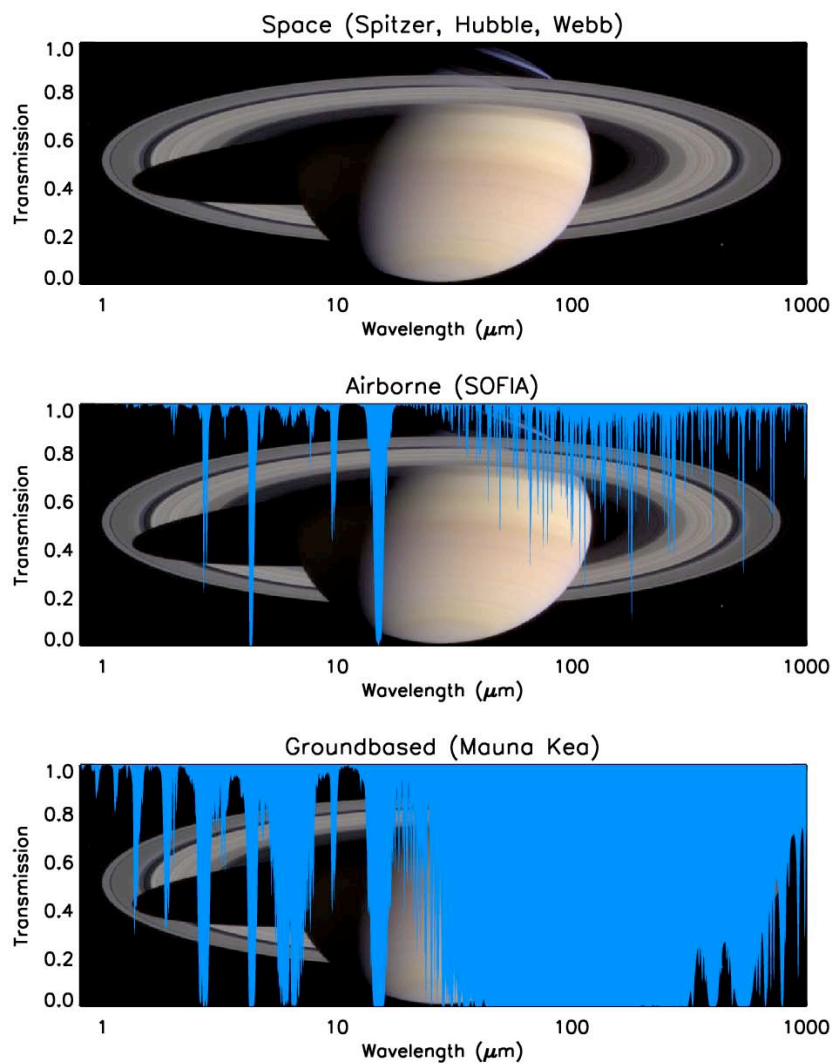

FIGURE 7.10 Our atmosphere blocks light from space, driving the need for telescopes at high altitudes. (*bottom*) On Mauna Kea (~14,000 feet above sea level), Earth’s atmosphere transmission is reduced to zero throughout much of the infrared regime; many windows in the near infrared are blocked as well. (*middle*) The airborne Stratospheric Observatory For Infrared Astronomy (SOFIA) reduces these losses by operating above the bulk of the atmosphere; at ~45,000 feet, the measured average transmission from 1 to 1000 μm is ≥ 80 percent except in the center of absorption lines due to mostly telluric H_2O , CO_2 , and O_2 . (*top*) Spaceborne telescopes such as Hubble, Herschel, Spitzer, and Webb are completely free of such effects. SOURCE: Spectra from www.spectrafactory.net, courtesy of Andrew Markwick, University of Manchester, U.K., and Jan Cami, and University of Western Ontario, Canada; Saturn image PIA06193, courtesy of NASA/JPL/Space Science Institute; composite created by Tim Warchockki.



FIGURE 7.11 The SOFIA observatory in flight. SOURCE: NASA.

The Stratospheric Observatory for Infrared Astronomy (SOFIA), a facility jointly operated by NASA and the German Aerospace Center DLR, is a 2.5-m telescope flying at 40,000 ft altitude. SOFIA will provide important infrared observations for outer planet observations, observing all four giant planets across their full bolometric spectrum. SOFIA's spectral coverage and resolution can discover and map many key molecules spatially and (via modeling of line profiles) vertically. (See Figures 7.10 and 7.11)

Significant planetary work can be done from balloon-based missions flying higher than 45,000 ft. This altitude provides access to electromagnetic radiation that would otherwise be absorbed by Earth's atmosphere and permits high spatial resolution imaging unaffected by atmospheric turbulence. These facilities offer a combination of cost, flexibility, risk tolerance and support for innovative solutions that is ideal for the pursuit of certain scientific opportunities, the development of new instrumentation, and infrastructure support. Given the rarity of giant planet missions, these types of observing platforms (high-altitude telescopes on balloons and sounding-rockets) can be used to fill an important data gap.¹⁰³

The Very Long Baseline Array (VLBA) is able to determine spacecraft positions to high accuracy (which allows the refinement of planetary ephemerides). The VLBA has also assisted in tracking probe release and descent (Cassini's Huygens spacecraft is an example).

In the microwave and submillimeter wavelength regions, two ground-based facilities are of great importance to giant planets: ALMA and the Expanded VLA. The VLA expansion project will be completed this decade and upon completion will produce high fidelity, wide-band imaging of the planets across the microwave spectrum. With a full suite of X- and Ka-band receivers, the VLA also provides a back-up downlink location to the DSN (Cassini has recently been successfully tracked with the VLA at Ka-band). Mission studies performed for this decadal survey showed, for example, that the best downlink location for an ice giant mission would be Goldstone; since the VLA is in the same footprint as Goldstone, it could provide a critical back-up. The sub-millimeter array, ALMA, will also come online this next decade and will provide unprecedented imagery of the giant planets in the relatively unexplored wavelength region from 0.3 mm to 3.6 mm (84 GHz to 950 GHz). ALMA will be an important tool for probing giant planet atmospheres in altitude and latitude. For ice giants, ALMA will probe through the stratosphere into the troposphere, and will have enough spatial sampling to get many resolution elements across each hemisphere.

ADVANCING STUDIES OF THE GIANT PLANETS: 2013-2022

Previously Recommended Missions

Cassini Solstice Mission

The Cassini spacecraft has returned an unprecedented volume of data from the Saturn system. It completed its main mission in 2008, returning nearly 2 terabytes of data on the planet, magnetosphere, rings and satellites. The mission has also completed its first extended mission, ending in mid-2010. During this time, many advances were made in our understanding of Saturn, including a new value for the most basic of quantities—its deep internal rotation rate. In addition, detailed observations showed the existence of a warm polar vortex, detailed 5-micron cloud structure, long-lived storms, and the presence of equatorial wind and temperature changes.

In the Solstice Mission, Cassini will continue its operations until a planned atmospheric entry in 2017. The value of this data set cannot be overestimated. The extended time base of observations is critical for understanding several aspects of Saturn's atmosphere, including the much longer and larger seasonal variations (as compared with Jupiter) as well as its long-period equatorial oscillation. The Solstice Mission results will provide many insights into the dynamics and circulation on this planet, as well as understanding of polar vortex formation, ring shadowing effects, and other atmospheric phenomena; it will also greatly extend the time baseline for the study of variable features in the rings, such as spokes, propellers, and noncircular ring edges, while permitting radio occultation probes of ring structure at many different incidence angles. In addition, the planned end-of-life scenario to place the craft into a Juno-like orbit (to constrain the internal mass distribution and higher order magnetic field components) adds an economic mini-mission that will allow comparison of the internal structure of Jupiter and Saturn.

Europa Geophysical Orbiter

The Europa Geophysical Orbiter recommended in the 2003 planetary decadal survey is now being studied in the context of a proposed joint NASA-ESA Europa Jupiter System Mission (EJSM). This cooperative venture combines a NASA-provided Jupiter Europa Orbiter (JEO) with an ESA-provided Ganymede orbiter. There is an extended period of time during Jupiter approach that is suitable for low-phase-angle observations of the jovian atmosphere and for Jupiter system observations that will enable time-domain science, including fluid dynamics studies. After Jupiter orbit insertion, there is a further 2- to 3-year period that could be dedicated to Jupiter system observations before each spacecraft achieves its final satellite orbit. With the available extended time and with jovian-atmosphere-specific instrumentation, these observations could provide significant insights into several remaining questions and poorly understood atmospheric phenomena, such as aurora and polar haze structure and interactions, wave-induced dynamical processes, and coupling across atmospheric boundary layers. Although the 2010 Science Definition Team Report expanded the mission science objectives to include some valuable Jupiter and ring science, the focus and priority remains Europa (see Chapter 8). The huge gaps in our knowledge of the Uranus and Neptune systems, combined with the narrower advances in Jupiter science, together put JEO at a lower priority for giant planet science than a mission to an ice giant.

Juno

The Juno mission was selected for the second of New Frontiers' launch opportunity. Due to launch in 2011 and arrive at Jupiter in 2016, Juno will study the planet's deep interior structure, abundance and distribution of water, and polar magnetic environment. Combined with results from the

PREPUBLICATION COPY—SUBJECT TO FURTHER EDITORIAL CORRECTION

Galileo probe and orbital mission, a number of spacecraft flybys, and the future EJSM mission, Juno will complete a comprehensive assessment of Jupiter, making it the best studied of the giant planets. Though it was not possible to include atmospheric probes on Juno, the mission is responsive to the last decadal survey's call for a New Frontiers mission to Jupiter, fulfilling a majority of the jovian science goals laid out in the decadal survey report.

New Missions

Flagship Missions

Uranus Orbiter and Probe

An ice-giant mission was identified as a deferred priority mission in the 2003 planetary decadal survey. The specific mission considered by the survey focused on the Neptune system, but did not have the benefit of detailed mission studies or the independent cost and technical evaluations (CATEs). For the current survey, the committee's studies identified significant challenges and risks associated with a Neptune mission that are not at play for a Uranus mission in the next decade (including risks associated with aerocapture at Neptune, and lack of optimal launch windows for Neptune in the upcoming decade, and long flight times incompatible with the ASRG system lifetimes).

The mission studies and CATEs performed for this decadal survey indicate it is possible to launch a Uranus mission within the next decade that will insert a fully equipped instrument package into orbit for a multi-year mission to study the atmosphere, rings, magnetic field, and magnetosphere, as well as deploy a small atmospheric in situ probe and conduct a tour of the larger satellites. A Uranus mission will permit in-depth study of a class of planets glimpsed only briefly during a fly-by mission carrying 1970s-era technology. Moreover, the CATE analysis indicated that much of that risk associated with this mission can be retired by studies of the ASRG power systems and proper preparations for probe entry.

The prioritized science objectives for a Uranus Orbiter and Probe mission are as follows:

- *Highest Priority Science Objectives*

1. Determine the atmospheric zonal winds, composition, and structure at high spatial resolution, as well as the temporal evolution of atmospheric dynamics.
2. Understand the basic structure of the planet's magnetosphere as well as the high-order structure and temporal evolution of the planet's interior dynamo.

- *Medium Priority Science Objectives*

3. Determine the noble gas abundances (He, Ne, Ar, Kr, and Xe) and isotopic ratios of H, C, N, and O in the planet's atmosphere and the atmospheric structure at the probe descent location.
4. Determine internal mass distribution.
5. Determine horizontal distribution of atmospheric thermal emission, as well as the upper atmospheric thermal structure and changes with time and location at low resolution.
6. Determine the geology, geophysics, surface composition, and interior structure of large satellites.

- *Lower Priority Science Objectives*

7. Measure the magnetic field, plasma, and currents to determine how the tilted/offset/rotating magnetosphere interacts with the solar wind over time.

PREPUBLICATION COPY—SUBJECT TO FURTHER EDITORIAL CORRECTION

8. Determine the composition, structure, particle-size distribution, dynamical stability, and evolutionary history of the rings, as well as the geology, geophysics, and surface composition of small satellites.

9. Determine the vertical profile of zonal winds as a function of depth in the atmosphere, in addition to the presence of clouds as a function of depth in the atmosphere.

New Frontiers Missions

The New Frontiers line is an essential component of NASA's portfolio. Missions of this scope can achieve highly focused goals that can be combined with results from flagship missions to significantly advance scientific progress. However, the committee's detailed mission studies revealed that the current cost cap of New Frontiers precluded nearly all outer solar system exploration. One exception was a Saturn Probe mission.

Saturn Probe

For a mission like the Saturn Probe, the current operating systems and protocols (extant paradigms and likely risk/cost analyses) dictate that launching and operating an empty rocket (zero payload) to fly past the Saturn system just barely fits within the 2009 New Frontiers cost cap. This is true for any mission beyond Saturn as well: similar results surfaced for other New Frontiers mission concepts to targets in the outer solar system. The Saturn Probe study was particularly illustrative because it was stripped down to almost an empty rocket and yet was still substantially over \$1 billion including launch costs (the committee examined a single-probe mission design; multiple probes would further enhance the science yield). For reference, an extremely capable payload is a small fraction of the cost of the rocket (and thus the mission): Phase A-D costs of the probe, including aeroshell and payload, are only of order 10 percent of the total mission cost; the science payload itself is only of order 3 percent.

The prioritized science objectives for a Saturn Probe mission under an expanded New Frontiers cost cap recommended in Chapter 9 are:

- *Highest Priority Science Objectives*

1. Determine the noble gas abundances and isotopic ratios of H, C, N, and O in Saturn's atmosphere.
2. Determine the atmospheric structure at the probe descent location acceleration.

- *Lower Priority Science Objectives*¹⁰⁴

3. Determine the vertical profile of zonal winds as a function of depth at the probe descent location(s).
4. Determine the location, density, and composition of clouds as a function of depth in the atmosphere.
5. Determine the variability of atmospheric structure and presence of clouds in two locations.
6. Determine the vertical water abundance profile at the probe descent location(s).
7. Determine precision isotope measurements for light elements such as S, N, and O found in simple atmospheric constituents.

The Saturn shallow probe targets very specific science goals. Retrieved elemental compositions from Saturn can be combined with those from the Jupiter/Galileo probe to constrain solar system formation models; in situ Saturn observations can leverage the results of remote sensing obtained with the

Cassini Mission. When a Saturn Probe mission is combined with a Uranus Orbiter and Probe mission, understanding of planetary formation will be greatly advanced in the next decade.

Space-based Telescopes

Missions to the outer solar system are expensive and risky, and therefore rare. While such missions acquire measurements unobtainable in any other way, their extended spacing in time severely limits the development of our understanding of giant planet systems. New knowledge for these planets has increasingly come from ground- and space-based telescopes. Advances in telescope technology (especially adaptive optics imaging) and focal-plane instrumentation have greatly expanded the capabilities of ground-based facilities. Observations from large facility-class telescopes such as Hubble, Herschel, Chandra, and Spitzer have shed light on numerous problems in giant planet science. Similarly, telescopic missions with tightly focused science goals have been ground breaking in astrophysics (FUSE, WMAP), in some cases garnering Nobel Prizes (e.g., COBE). Remote-sensing observations provide scientific advances at a fraction of the cost of deep-space missions; they are also shared facilities with other disciplines, further reducing cost. Young scientists trained on these facilities will be available to participate in the deep space missions of the future, when scientists trained on Voyager, Galileo, and Cassini have retired.

Ultraviolet and x-ray planetary observations require a telescope above 110 km altitude, where imaging and spectroscopy can be accomplished undistorted by the atmosphere. After the Hubble and Chandra missions conclude some time in the coming decade, such observations will no longer be possible. The scientific case for remote multi-wavelength observations of single solar system objects has been made in numerous Small Explorer (SMEX) and Discovery proposals, with at least two Phase A SMEX studies. The science case is strengthened greatly by inclusion of multiple planets, satellites, and small bodies, yet there is no program presently in NASA where such a mission—for observations of solar system objects in general—can be proposed, since Discovery class missions are defined as focused on single systems. Presentations to the committee suggested that a highly capable planetary space telescope in Earth orbit could be accomplished as a Discovery mission. Such a facility could support all solar system scientific research, not just giant planets.

Concluding Thoughts

The painful reality of giant planet exploration is that even the revised the New Frontiers cost cap proposed in this survey severely restricts mission options within the Saturn system, and precludes any mission to an ice giant. If NASA wants to explore beyond the orbit of Jupiter, NASA must accept that there are risks associated with that exploration (long timescales, limited power options, etc), and that there are concomitant costs associated with those risks.

The good news is that we need not wait for a huge flagship to make substantial scientific gains in the outer solar system. The Giant Planets Panel identifies two missions that balance the challenge of deep solar system exploration with the risks and cost: a scientifically compelling New Frontiers candidate within the Saturn system, and a scientifically rich mission to the Uranus system that costs much less than past flagships.

Exploration of giant planet systems offers rich connections to missions whose primary focus is the satellites of those systems; likewise, most satellite missions have the potential for giant-planet system science. The very name of the Europa-Jupiter System Mission evokes this synergy. Likewise, any mission to an ice giant system will offer significant opportunities for satellite science. A Saturn Probe mission may have limited satellite capability, but depending on carrier instrumentation and specific trajectories, some Titan science might be feasible. Because some satellites of the giant planets are often captured objects (e.g., Triton, Phoebe), there is linkage to the primitive bodies community as well.

Summary

To achieve the primary goals of the scientific study of giant planet systems as outlined in this chapter, the following objectives will have to be addressed.

- *Flagship missions*—As discussed in this chapter and in the previous decadal survey, a comprehensive mission to study one of the ice giants offers enormous potential for new discoveries. The committee investigated missions to both Uranus and Neptune, and determined that the two systems offered equally rich science return. The Uranus mission is preferred for the decade 2013-2022 both because of the more difficult requirements of achieving Neptune orbit and the availability of favorable Uranus trajectories in the coming decade.

The Jupiter Europa Orbiter component of the NASA-ESA Europa Jupiter System Mission will advance studies of the giant planets provided it:¹⁰⁵

1. Maintains Jupiter system science as high priority by allowing Jupiter-specific instrumentation and investigations;
2. Designates Jupiter system science as the top-ranked priority during the approach and early jovian tour phases, and devote spacecraft resources accordingly (e.g., data volume and observing time); and
3. Incorporates Jupiter system science specific needs, such as lighting conditions and viewing geometry, into jovian tour design decisions.

- *New Frontiers missions*—The current New Frontiers cost cap is insufficient to permit many of the missions of the highest interest; even those with highly focused science goals. A possible exception to this is the Saturn Probe mission, if the payload is lean and the New Frontiers cost cap is expanded slightly. The Saturn Probe mission will make important contributions to addressing giant planet goals in the period 2013-2022 by providing measurements of noble gas abundances that can be obtained in no other way and, thus, placing Saturn into context relative to Jupiter and the Sun.

- *Discovery missions*—Permit proposals for targeted and facility-class orbital space telescopes in response to future Discovery announcements of opportunity. If this is to happen, the science addressed by such facilities needs to be listed as a priority for the Discovery program.

- *Technology development*—Continue developments in the following prioritized areas: power needs; thermal protection systems for atmospheric probes; aerocapture and/or nuclear-electric propulsion; and robust deep-space communications capabilities.

- *Research support*—Maintain robust programs of synoptic observations of the giant planets, data analysis, laboratory work, theoretical studies, and computational development.

- *Observing facilities*—Assure access to large telescopes for giant planet systems science observations. The long timescales between giant planet missions requires substantial support of ground-based facilities for mission planning. The extreme distances to the giant planets necessitate very high spatial resolution and high sensitivity, requiring the largest and most sensitive astronomical facilities on Earth and in space.

- *Data archiving*—Support the ongoing effort to evolve the Planetary Data System from an archiving facility to an effective online resource for the NASA and international communities.

NOTES AND REFERENCES

1. National Research Council. 2003. *New Frontiers in the Solar System: An Integrated Exploration Strategy*. The National Academies Press, Washington, D.C.
2. H.F. Levison and C. Agnor (2003). The Role of Giant Planets in Terrestrial Planet Formation. *Astronomical Journal*, Volume 125, pp. 2692-2713

PREPUBLICATION COPY—SUBJECT TO FURTHER EDITORIAL CORRECTION

3. R. Brasser, A. Morbidelli, R. Gomes, K. Tsiganis, and H.F. Levison, (2009) Constructing the secular architecture of the solar system II: the terrestrial planets, *Astronomy and Astrophysics*, Volume 507, pp. 1053-1065
4. W. Borucki for the Kepler Team. 2010. Characteristics of Kepler planetary candidates based on the first data set: The majority are found to be Neptune-size and smaller. arXiv:1006.2799v1 [astro-ph.EP].
5. J.I. Lunine, D. Fischer, H.B. Hammel, T. Henning, L. Hillenbrand, J. Kasting, G. Laughlin, B. Macintosh, M. Marley, G. Melnick, D. Monet, et al. 2008. Worlds beyond: A strategy for the detection and characterization of exoplanets. Executive Summary of a Report of the ExoPlanet Task Force Astronomy and Astrophysics Advisory Committee, Washington, D.C., June 23, 2008. *Astrobiology* 8:875-881.
6. W. Borucki for the Kepler Team. 2010. Characteristics of Kepler planetary candidates based on the first data set: The majority are found to be Neptune-size and smaller. arXiv:1006.2799v1 [astro-ph.EP].
7. T. Sumi, D.P. Bennett, I.A. Bond, A. Udalski, V. Batista, M. Dominik, P. FouquZe, D. Kubas, A. Gould, B. Macintosh, K. Cook, et al. 2010. A cold Neptune-mass planet OGLE-2007-BLG-368Lb: Cold Neptunes are common. *Astrophysical Journal* 710:1641-1653.
8. T. Sumi, D.P. Bennett, I.A. Bond, A. Udalski, V. Batista, M. Dominik, P. FouquZe, D. Kubas, A. Gould, B. Macintosh, K. Cook, et al. 2010. A cold Neptune-mass planet OGLE-2007-BLG-368Lb: Cold Neptunes are common. *Astrophysical Journal* 710:1641-1653.
9. C. Lovos, D. Ségransan, M. Mayor, S. Udry, F. Pepe, D. Queloz, W. Benz, F. Bouchy, C. Mordasini, N.C. Santos, J. Laskar, A. Correia, J.-L. Bertaux, and G. Lo Curto. 2010. The HARPS search for southern extra-solar planets. XXVII. Up to seven planets orbiting HD 10180: Probing the architecture of low-mass planetary systems. *Astronomy and Astrophysics*, submitted.
10. W. Borucki for the Kepler Team. 2010. Characteristics of Kepler planetary candidates based on the first data set: The majority are found to be Neptune-size and smaller. arXiv:1006.2799v1 [astro-ph.EP].
11. J.I. Lunine, D. Fischer, H.B. Hammel, T. Henning, L. Hillenbrand, J. Kasting, G. Laughlin, B. Macintosh, M. Marley, G. Melnick, D. Monet, et al. 2008. Worlds beyond: A strategy for the detection and characterization of exoplanets, Executive Summary of a Report of the ExoPlanet Task Force Astronomy and Astrophysics Advisory Committee, Washington, D.C., June 23, 2008. *Astrobiology* 8:875-881.
12. J. Pearl, B.J. Conrath, R.A. Hanel, J.A. Pirraglia, and A. Coustenis. 1990. The albedo, effective temperature, and energy balance of Uranus, as determined from the Voyager IRIS data. *Icarus* 84:12.
13. B.J. Conrath, F.M. Flasar, and P.J. Gierasch. 1991. Thermal structure and dynamics of Neptune's atmosphere from Voyager measurements. *J. Geophys. Res.* 96:18931.
14. White papers received by decadal survey: Wesley A. Traub, Exoplanets and Solar System Exploration; Jonathan J. Fortney, Planetary Formation and Evolution Revealed with Saturn Entry Probe; Mark Hofstadter, The Atmospheres of the Ice Giants, Uranus and Neptune; Candice J. Hansen, Neptune Science with Argo—A Voyage through the Outer Solar System.
15. White papers received by decadal survey: David H. Atkinson, Entry Probe Missions to the Giant Planets; Jonathan J. Fortney, Planetary Formation and Evolution Revealed with Saturn Entry Probe.
16. White papers received by decadal survey: Karla B. Clark, Europa Jupiter System Mission; William B. McKinnon, Exploration Strategy for the Outer Planets 2013-2022: Goals and Priorities.
17. White papers received by decadal survey: David H. Atkinson, Entry Probe Missions to the Giant Planets; Jonathan J. Fortney, Planetary Formation and Evolution Revealed with Saturn Entry Probe.
18. White papers received by decadal survey: Mark Hofstadter, The Atmospheres of the Ice Giants, Uranus and Neptune; Candice J. Hansen, Neptune Science with Argo—A Voyage through the

Outer Solar System; William B. McKinnon, *Exploration Strategy for the Outer Planets 2013-2022: Goals and Priorities*.

19. H.F. Wilson and B. Militzer. 2010. Sequestration of noble gases in giant planet interiors. *Phys. Rev. Lett.* 104:121101.
20. T. Owen, P. Mahaffy, H.B. Niemann, S. Atreya, T. Donahue, A. Bar-Nun, and I. de Pater. 1999. A low-temperature origin for the planetesimals that formed Jupiter. *Nature* 402:269-270.
21. D. Gautier, F. Hersant, O. Mousis, and J.I. Lunine. 2001. Enrichments in volatiles in Jupiter: A new interpretation of the Galileo measurements. *Astrophysical Journal Letters* 550:L227-L230.
22. F. Hersant, D. Gautier, G. Tobie, and J.I. Lunine. 2008. Interpretation of the carbon abundance in Saturn measured by Cassini. *Planetary and Space Science* 56:1103-1111.
23. T. Guillot and R. Hueso. 2006. The composition of Jupiter: Sign of a (relatively) late formation in a chemically evolved protosolar disc. *Monthly Notices of the Royal Astronomical Society: Letters* 367(1):L47-L51.
24. F. Hersant, D. Gautier, G. Tobie, and J.I. Lunine. 2008. Interpretation of the carbon abundance in Saturn measured by Cassini. *Planetary and Space Science* 56:1103-1111.
25. T. Owen, P. Mahaffy, H.B. Niemann, S. Atreya, T. Donahue, A. Bar-Nun, and I. de Pater. 1999. A low-temperature origin for the planetesimals that formed Jupiter. *Nature* 402:269-270.
26. White papers received by decadal survey: Jonathan J. Fortney, *Planetary Formation and Evolution Revealed with Saturn Entry Probe*, David H. Atkinson, *Entry Probe Missions to the Giant Planets*; Mark Hofstadter, *The Atmospheres of the Ice Giants, Uranus and Neptune*; Candice J. Hansen, *Neptune Science with Argo—A Voyage through the Outer Solar System*; Wesley A. Traub, *Exoplanets and Solar System Exploration*.
27. C. Marois, B. Macintosh, T. Barman, B. Zuckerman, I. Song, J. Patience, D. Lafrenière, and R. Doyon. 2008. Direct imaging of multiple planets orbiting the star HR 8799. *Science* 322:1348.
28. White papers received by decadal survey: Mark Hofstadter, *The Atmospheres of the Ice Giants, Uranus and Neptune*; Candice J. Hansen, *Neptune Science with Argo—A Voyage through the Outer Solar System*; Jonathan J. Fortney, *Planetary Formation and Evolution Revealed with Saturn Entry Probe*; Wesley A. Traub, *Exoplanets and Solar System Exploration*; C. Agnor, *The Exploration of Neptune and Triton*.
29. P. Bodenheimer, D.N.C. Lin, and R.A. Mardling. 2001. On the tidal inflation of short-period extrasolar planets. *Astrophysical Journal* 548:466-472.
30. J. Harrington, I. de Pater, S.H. Brecht, D. Deming, V. Meadows, K. Zahnle, and P.D. Nicholson. 2004. Lessons from Shoemaker-Levy 9 about Jupiter and planetary impacts. Pp. 159-184 in *Jupiter: The Planet, Satellites and Magnetosphere* (F. Bagenal, T. Dowling, and W. McKinnon, eds.). Cambridge University Press, New York.
31. A. Sánchez-Lavega, A. Wesley, G. Orton, R. Hueso, S. Perez-Hoyos, L.N. Fletcher, P. Yanamandra-Fisher, J. Legarreta, I. de Pater, H. Hammel, A. Simon-Miller, et al. 2010. The impact of a large object with Jupiter in July 2009. *Astrophysical Journal Letters* 210:L155-L159.
32. R. Hueso, A. Wesley, C. Go, M. H. Wong, L. N. Fletcher, A. Sánchez-Lavega, M. B. E. Boslough, I. de Pater, G. Orton, A. A. Simon-Miller, S. G. Djorgovski, M. L. Edwards, H. B. Hammel, J. T. Clarke, K. Noll, and P. Yanamandra-Fisher. 2010. First Earth-based detection of a superbolide on Jupiter. *Astrophysical Journal Letters* 721:L129-L133.
33. K. Zahnle, M. Marley, and J Fortney. 2009. Thermometric Soots on Warm Jupiters? arXiv:0911.0728 [astro-ph.EP].
34. P. Zarka (2007), Interactions of exoplanets with their parent star and associated radio emissions, *Planetary and Space Science*, Volume 55, Issue 5, p. 598-617.
35. K. France, J. T. Stocke, H. Yang, J. L. Linsky, B. C. Wolven, C. S. Froning1, J. C. Green and S. N. Osterman, Searching for far-ultraviolet auroral/dayglow emission from HD 209458b, *Astrophysical Journal*, Volume 712, Issue 2, pp. 1277-1286 (2010)

36. White papers received by decadal survey: Karla B. Clark, Europa Jupiter System Mission; William B. McKinnon, Exploration Strategy for the Outer Planets 2013-2022: Goals and Priorities.
37. White papers received by decadal survey: Mark Hofstadter, The Atmospheres of the Ice Giants, Uranus and Neptune; Wesley A. Traub, Exoplanets and Solar System Exploration; C. Agnor, The Exploration of Neptune and Triton.
38. National Research Council. 2003. *New Frontiers in the Solar System: An Integrated Research Strategy*. The National Academies Press, Washington, D.C.
- 39 T. I. Gombosi and A. P. Ingersoll Saturn: Atmosphere, Ionosphere, and Magnetosphere. *Science*, Volume 327, Issue 5972, pp. 1476- 1479 (2010).
- 40 J. N. Cuzzi, J. A. Burns, S. Charnoz, R. N. Clark, J. E. Colwell, L. Dones, L. W. Esposito, G. Filacchione, R. G. French, M. M. Hedman, S. Kempf, E. A. Marouf, C. D. Murray, P. D. Nicholson, C. C. Porco, J. Schmidt, M. R. Showalter, L. J. Spilker, J. N. Spitale, R. Srama, M. Sremčević, M. S. Tiscareno, and J. Weiss. An Evolving View of Saturn’s Dynamic Rings , *Science*, Volume 327, Issue 5972, pp. 1470- 1475 (2010).
41. National Research Council. 2003. *New Frontiers in the Solar System: An Integrated Research Strategy*. The National Academies Press, Washington, D.C.
42. M.K. Gordon, S. Araki, G.J. Black, A.S. Bosh, A. Brahic, S.M. Brooks, S. Charnoz, J.E. Colwell, J.N. Cuzzi, L. Dones, R.H. Durisen, et al. 2002. Planetary rings. Pp. 263-282 in *The Future of Solar System Exploration, 2003-2013. Community Contributions to the NRC Solar System Exploration Decadal Survey*. (M.V. Sykes, ed.). ASP Conference Series 272. Astronomical Society of the Pacific, Orem, Utah. Available at http://www.asppubs.org/a/volumes/table_of_contents/?book_id=13.
43. M.S. Tiscareno, J.A. Burns, M. Sremcevic, K. Beurle, M.M. Hedman, N.J. Cooper, A.J. Milano, M.W. Evans, C.C. Porco, J.N. Spitale, and J.W. Weiss. 2010. Physical characteristics and non-keplerian orbital motion of “propeller” moons embedded in Saturn’s rings. *Astrophys. J. Lett.* 718:L92-L96.
44. K. Beurle, C.D. Murray, G.A. Williams, M.W. Evans, N.J. Cooper, and C.B. Agnor. 2010. Direct evidence for gravitational instability and moonlet formation in Saturn’s rings. *Astrophys. J. Lett.* 718:L176-L180.
45. C.C. Porco, P.C. Thomas, J.W. Weiss, and D.C. Richardson. 2007. Saturn’s small inner satellites: Clues to their origins. *Science* 318:1602-1607.
46. S. Charnoz, A. Brahic, P.C. Thomas, and C.C. Porco. 2007. The equatorial ridges of Pan and Atlas: Terminal accretionary ornaments? *Science* 318:1622-1624.
47. S. Charnoz, J. Salmon, and A. Crida. 2010. The recent formation of Saturn’s moonlets from viscous spreading of the main rings. *Nature* 465:752-754.
48. I. de Pater, S. Gibbard, E. Chiang, H.B. Hammel, B. Macintosh, F. Marchis, S. Martin, H.G. Roe, and M. Showalter. 2005. The dynamic neptunian ring arcs: gradual disappearance of Liberté and a resonant jump of Courage. *Icarus* 174:263-272.
49. M.R. Showalter and J.J. Lissauer. 2006. The second ring-moon system of Uranus: Discovery and dynamics. *Science* 311:973-977.
50. I. de Pater, H.B. Hammel, S.G. Gibbard, and M.R. Showalter. 2006. New dust belts of Uranus: One ring, two ring, red ring, blue ring. *Science* 312:92-94.
51. I. de Pater, H.B. Hammel, M.R. Showalter, and M.A. van Dam. 2007. The dark side of the rings of Uranus. *Science* 317:1888-1890.
52. White papers received by decadal survey: Matthew S. Tiscareno, Rings Research in the Next Decade; Candice J. Hansen, Neptune Science with Argo—A Voyage through the Outer Solar System; Mark Hofstadter, The Atmospheres of the Ice Giants, Uranus and Neptune.
53. White papers received by decadal survey: Matthew S. Tiscareno, Rings Research in the Next Decade.

54. White papers received by decadal survey: Matthew S. Tiscareno, Rings Research in the Next Decade; William B. McKinnon, Exploration Strategy for the Outer Planets 2013-2022: Goals and Priorities; Linda J. Spilker, Cassini-Huygens Solstice Mission.
55. White papers received by decadal survey: Matthew S. Tiscareno, Rings Research in the Next Decade; William B. McKinnon, Exploration Strategy for the Outer Planets 2013-2022: Goals and Priorities; Julie C. Castillo-Rogez, Laboratory Studies in Support of Planetary Geophysics; M. Gudipati, Laboratory Studies for Planetary Sciences.
56. K. Tsiganis, R. Gomes, A. Morbidelli, and H.F. Levison. 2005. Origin of the orbital architecture of the giant planets of the solar system. *Nature* 435:459-461.
57. A. Morbidelli, H.F. Levison, K. Tsiganis, and R. Gomes. 2005. Chaotic capture of Jupiter's Trojan asteroids in the early solar system. *Nature* 435:462-465.
58. J.A. Fernandez and W. Ip. 1984. Some dynamical aspects of the accretion of Uranus and Neptune: The exchange of orbital angular momentum with planetesimals. *Icarus* 58:109-120.
59. R. Malhotra. 1993. Orbital resonances in the solar nebula: Strengths and weaknesses. *Icarus* 106:264.
60. R. Malhotra. 1995. The origin of Pluto's orbit: Implications for the solar system beyond Neptune. *Astronomical Journal* 110:420.
61. J.J. Lissauer, J.B. Pollack, G.W. Wetherill, and D.J. Stevenson. 1995. Formation of the Neptune system. Pp. 37-108 in *Neptune and Triton* (D.P. Cruikshank, M.S. Matthews, and A.M. Schumann, eds.).
62. E. Kokubo and S. Ida. 1998. Oligarchic growth of protoplanets. *Icarus* 131:171-178.
63. P. Goldreich, Y. Lithwick, and R. Sari. 2004. Final stages of planet formation. *Astrophysical Journal* 614:497-507.
64. White papers received by decadal survey: Jonathan J. Fortney, Planetary Formation and Evolution Revealed with Saturn Entry Probe; David H. Atkinson, Entry Probe Missions to the Giant Planets; Wesley A. Traub, Exoplanets and Solar System Exploration.
65. White papers received by decadal survey: Jonathan J. Fortney, Planetary Formation and Evolution Revealed with Saturn Entry Probe; David H. Atkinson, Entry Probe Missions to the Giant Planets; Wesley A. Traub, Exoplanets and Solar System Exploration; William B. McKinnon, Exploration Strategy for the Outer Planets 2013-2022: Goals and Priorities; Mark Hofstadter, The Case for a Uranus Orbiter.
66. J. Horner, B.W. Jones, J. Chambers, J. (2010). *International Journal of Astrobiology*, Volume 9, Issue 1, p. 1-10.
67. White papers received by decadal survey: Glenn S. Orton, Earth-Based Observational Support for Spacecraft Exploration of Outer-Planet Atmospheres; Anthony Wesley, Ground-Based Support for Solar-System Exploration: Continuous Coverage Visible Light Imaging of Solar System Objects from a Network of Ground-Based Observatories.
68. P.R. Estrada and J.N. Cuzzi. 1996. Voyager observations of the color of Saturn's rings. *Icarus* 122:251-272.
69. J.R. Spencer and T. Denk. 2010. Formation of Iapetus' extreme albedo dichotomy by exogenically triggered thermal ice migration. *Science* 327:432-435.
70. White papers received by decadal survey: Candice J. Hansen, Triton Science with Argo—A Voyage through the Outer Solar System; C. Agnor, The Exploration of Neptune and Triton; Mark Hofstadter, The Atmospheres of the Ice Giants, Uranus and Neptune; Matthew S. Tiscareno, Rings Research in the Next Decade.
71. A. Sanchez-Lavega, S. Perez-Hoyos, J.F. Rojas, R. Hueso, and R.G. French. 2003. A strong decrease in Saturn's equatorial jet at cloud level. *Nature* 423:623-625.

72. G.S. Orton, P.A. Yanamandra-Fisher, B.M. Fisher, A.J. Friedson, P.D. Parrish, J.F. Nelson, A.S. Bauermeister, L. Fletcher, D.Y. Gezari, F. Varosi, A.T. Tokunaga, et al. 2008. Semi-annual oscillations in Saturn's low-latitude stratospheric temperatures. *Nature* 453:196-199.
73. T. Fouchet, S. Guerlet, D.F. Strobel, A.A. Simon-Miller, B. Bézard, and F.M. Flasar. 2008. An equatorial oscillation in Saturn's middle atmosphere. *Nature* 453:200-202.
74. G.S. Orton and P.A. Yanamandra-Fisher. 2005. Saturn's temperature field from high-resolution middle-infrared imaging. *Science* 307:696-698.
75. Orton et al. unpublished data. .
76. H.B. Hammel, M.L. Sitko, G.S. Orton, T. Geballe, D.K. Lynch, R.W. Russell, and I. de Pater. 2007. Distribution of ethane and methane emission on Neptune. *Astronomical Journal* 134:637-641.
77. White papers received by decadal survey: Karla B. Clark, Europa Jupiter System Mission; William B. McKinnon, Exploration Strategy for the Outer Planets 2013-2022: Goals and Priorities, and to some extent by Cassini for Saturn; Linda J. Spilker, Cassini-Huygens Solstice Mission; Glenn S. Orton, Earth-Based Observational Support for Spacecraft Exploration of Outer-Planet Atmospheres; Mark Hofstadter, The Case for a Uranus Orbiter; C. Agnor, The Exploration of Neptune and Triton; Wesley A. Traub, Exoplanets and Solar System Exploration.
78. White paper received by decadal survey: Linda J. Spilker, Cassini-Huygens Solstice Mission.
79. White papers received by decadal survey: Linda J. Spilker, Cassini-Huygens Solstice Mission; Karla B. Clark, Europa Jupiter System Mission.
80. V. Lainey and T. van Hoolst. 2009. Jovian tidal dissipation from inner satellite dynamics. European Planetary Science Congress 2009. *EPSC Abstracts* 4:EPSC2009-392.
81. See, e.g., A.P. Ingersoll, T.E. Dowling, P.J. Gierasch, G.S. Orton, P.L. Read, A. Sanchez-Lavega, A.P. Showman, A.A. Simon-Miller, and A.R. Vasavada. 2004. Dynamics of Jupiter's atmosphere. Pp. 105-128 in *Jupiter: The Planet, Satellites and Magnetosphere* (F. Bagenal, T. Dowling, and W. McKinnon, eds.). Cambridge University Press, New York.
82. A. Sanchez-Lavega, S. Perez-Hoyos, J.F. Rojas, R. Hueso, and R.G. French. 2003. A strong decrease in Saturn's equatorial jet at cloud level. *Nature* 423:623-625.
83. F.M. Flasar, R.K. Achterberg, B.J. Conrath, J.C. Pearl, G.L. Bjoraker, D.E. Jennings, P.N. Romani, A.A. Simon-Miller, V.G. Kunde, C.A. Nixon, B. Bézard, G.S. Orton, et al. 2005. Temperatures, winds, and composition in the saturnian system. *Science* 307:1247-1251.
84. S. Pérez-Hoyos and A. Sánchez-Lavega. 2006. On the vertical wind shear of Saturn's equatorial jet at cloud level. *Icarus* 180:161-175.
85. A.W. Brinkman and J. McGregor. 1979. The effect of the ring system on the solar radiation reaching the top of Saturn's atmosphere: Direct radiation. *Icarus* 38:479-482.
86. L.A. Sromovsky, P.M. Fry, S.S. Limaye, and K.H. Baines. 2003. The nature of Neptune's increasing brightness: Evidence for a seasonal response. *Icarus* 163:256-261.
87. H.B. Hammel and G.W. Lockwood. 2007. Long-term atmospheric variability on Uranus and Neptune. *Icarus* 186:291-301.
88. L.A. Sromovsky, P.M. Fry, W.M. Ahue, H.B. Hammel, I. de Pater, K.A. Rages, M.R. Showalter, and M.A. van Dam. 2009. Uranus at equinox: Cloud morphology and dynamics. *Icarus* 203:265-286.
89. L.A. Sromovsky and P.M. Fry. 2005. Dynamics of cloud features on Uranus. *Icarus* 179:459-484.
90. H.B. Hammel, L.A. Sromovsky, P.M. Fry, K.A. Rages, M.R. Showalter, I. de Pater, M.A. van Dam, R.P. LeBeau, and X. Deng. 2009. The dark spot in the atmosphere of Uranus in 2006: Discovery, description, and dynamical simulations. *Icarus* 201:257-271.
91. S.H. Luszcz-Cook, I. de Pater, H.B. Hammel, and M. Ádámkóvics. 2010. Seeing double at Neptune's south pole. *Icarus*, in press.

92. White papers received by decadal survey: David H. Atkinson, Entry Probe Missions to the Giant Planets; Jonathan J. Fortney, Planetary Formation and Evolution Revealed with Saturn Entry Probe.

93. White papers received by decadal survey: David H. Atkinson, Entry Probe Missions to the Giant Planets; Jonathan J. Fortney, Planetary Formation and Evolution Revealed with Saturn Entry Probe; Wesley A. Traub, Exoplanets and Solar System Exploration; William B. McKinnon, Exploration Strategy for the Outer Planets 2013-2022: Goals and Priorities; Mark Hofstadter, The Case for a Uranus Orbiter.

94. National Research Council, Plasma Physics of the Local Cosmos, The National Academies Press, Washington, D.C., 2004.

95. W. Borucki for the Kepler Team. 2010. Characteristics of Kepler planetary candidates based on the first data set: The majority are found to be Neptune-size and smaller. arXiv:1006.2799v1 [astro-ph.EP].

96. White papers received by decadal survey: Jonathan J. Fortney, Planetary Formation and Evolution Revealed with Saturn Entry Probe; Wesley A. Traub, Exoplanets and Solar System Exploration.

97. White paper received by decadal survey: William B. McKinnon, Exploration Strategy for the Outer Planets 2013-2022: Goals and Priorities.

98. White papers received by decadal survey: Patricia M. Beauchamp, Technologies for Outer Planet Missions: A Companion to the Outer Planet Assessment Group (OPAG); William B. McKinnon, Exploration Strategy for the Outer Planets 2013-2022: Goals and Priorities.

99. White papers received by decadal survey: Candice J. Hansen, Neptune Science with Argo—A Voyage through the Outer Solar System; Mark Hofstadter, The Atmospheres of the Ice Giants, Uranus and Neptune.

100. White paper received by decadal survey: George Sonneborn, Study of Planetary Systems and Solar System Objects with JWST.

101. White paper received by decadal survey: Alan Tokunaga, The NASA Infrared Telescope Facility.

102. White papers received by decadal survey: Anthony Wesley, Ground-Based Support for Solar-System Exploration: Continuous Coverage Visible Light Imaging of Solar System Objects from a Network of Ground-Based Observatories.

103. White papers received by decadal survey: Eliot F. Young, Balloon-Borne Telescopes for Planetary Science: Imaging and Photometry; Charles A. Hibbits, Stratospheric Balloon Missions for Planetary Science; William B. McKinnon, Exploration Strategy for the Outer Planets 2013-2022: Goals and Priorities.

104. Note that the mission studied by the committee and subject to CATE analysis did not include lower priority science objectives .

105. 2010 Joint Jupiter Science Definition Team Report to NASA.

8

Satellites:

Active Worlds and Extreme Environments

This chapter is devoted to the major satellites of the giant planets: those large enough to have acquired a roughly spherical shape through self-gravity. There are 17 of these worlds (four at Jupiter, seven at Saturn, five at Uranus, and one at Neptune), ranging in diameter from 5260 kilometers (Ganymede) to 400 kilometers (Mimas) (Table 8.1, Figure 8.1). They are astonishingly diverse, with surface ages spanning more than 4 orders of magnitude, and surface materials ranging from molten silicate lava to nitrogen frost. This diversity makes the satellites exceptionally interesting scientifically, illuminating the many evolutionary paths that planetary bodies can follow as a function of their size, composition, and available energy sources, and allowing us to investigate and understand an exceptional variety of planetary processes. However, this diversity also presents a challenge for any attempt to prioritize exploration of these worlds, as we move from initial reconnaissance to focused in-depth studies.

The sizes, masses, and orbits of all the large satellites are now well known, and are key constraints on the origin of the planetary systems to which they belong. Additional constraints come from their detailed compositions, which we are just beginning to investigate. Several worlds have unique stories to tell us about the evolution of habitable worlds, by illuminating tidal heating mechanisms, providing planetary-scale laboratories for the evolution of organic compounds, and by harboring potentially habitable subsurface environments. Many of these worlds feature active planetary processes that are important for understanding both these bodies themselves, and worlds throughout the solar system. These processes include silicate volcanism, ice tectonics, impacts, atmospheric escape, chemistry, and dynamics, and magnetospheric processes.

While much can still be learned from ground-based and near-Earth telescopic observations, particularly in the temporal domain, and from analysis of existing data, missions to these worlds are required to produce new breakthroughs in our understanding. During the past decade, our understanding of these worlds has been substantially expanded by the Cassini spacecraft and its Huygens probe that descended to Titan in 2005. Data from Cassini continues to revise and expand what we know about Saturn's moons. In addition, continued analysis from past missions such as Galileo has produced surprises as well as helping inform the planning for future missions.

TABLE 8.1 Characteristics of the Large- and Medium-Size Satellites of the Giant Planets

Primary	Satellite	Distance from Primary (km)	Radius (km)	Bulk Density (g cm^{-3})	Geometric Albedo	Dominant Surface Composition	Surface Atmospheric Pressure (bars)	Dominant Atmospheric Composition	Notes
Jupiter	Io	422,000	1822	3.53	0.6	S, SO ₂ , silicates	10 ⁻⁹	SO ₂	Intense tidally driven volcanism, plumes, high mountains
	Europa	671,000	1561	3.01	0.7	H ₂ O, hydrates	10 ⁻¹²	O ₂	Recent complex resurfacing, probable subsurface ocean
	Ganymede	1,070,000	2631	1.94	0.4	H ₂ O, hydrates	10 ⁻¹²	O ₂	Magnetic field, ancient tectonism, probable subsurface ocean
	Callisto	1,883,000	2410	1.83	0.2	Phyllosilicates?, H ₂ O			Partially undifferentiated, heavily cratered, probable subsurface ocean
Saturn	Mimas	186,000	198	1.15	0.6	H ₂ O			Heavily cratered
	Enceladus	238,000	252	1.61	1.0	H ₂ O			Intense recent tectonism, active water vapor/ice jets
	Tethys	295,000	533	0.97	0.8	H ₂ O			Heavily cratered, fractures
	Dione	377,000	562	1.48	0.6	H ₂ O			Limited resurfacing, fractures
	Rhea	527,000	764	1.23	0.6	H ₂ O			Heavily cratered, fractures
	Titan	1,222,000	2576	1.88	0.2	H ₂ O, organics, liquid CH ₄	1.5	N ₂ , CH ₄	Active hydrocarbon hydrological cycle, complex organic chemistry
	Iapetus	3,561,000	736	1.08	0.3	H ₂ O, organics?			Heavily cratered, extreme albedo dichotomy
Uranus	Miranda	130,000	236	1.21	0.3	H ₂ O			Complex and inhomogeneous resurfacing
	Ariel	191,000	579	1.59	0.4	H ₂ O			Limited resurfacing, fractures
	Umbriel	266,000	585	1.46	0.2	H ₂ O, dark material			Heavily cratered
	Titania	436,000	789	1.66	0.3	H ₂ O			Limited resurfacing, fractures
	Oberon	584,000	761	1.56	0.2	H ₂ O, dark material			Limited resurfacing
Neptune	Triton	355,000	1353	2.06	0.8	N ₂ , CH ₄ , H ₂ O	10 ⁻⁵	N ₂ , CH ₄	Captured. Recent resurfacing, complex geology, active plumes

PREPUBLICATION COPY—SUBJECT TO FURTHER EDITORIAL CORRECTION

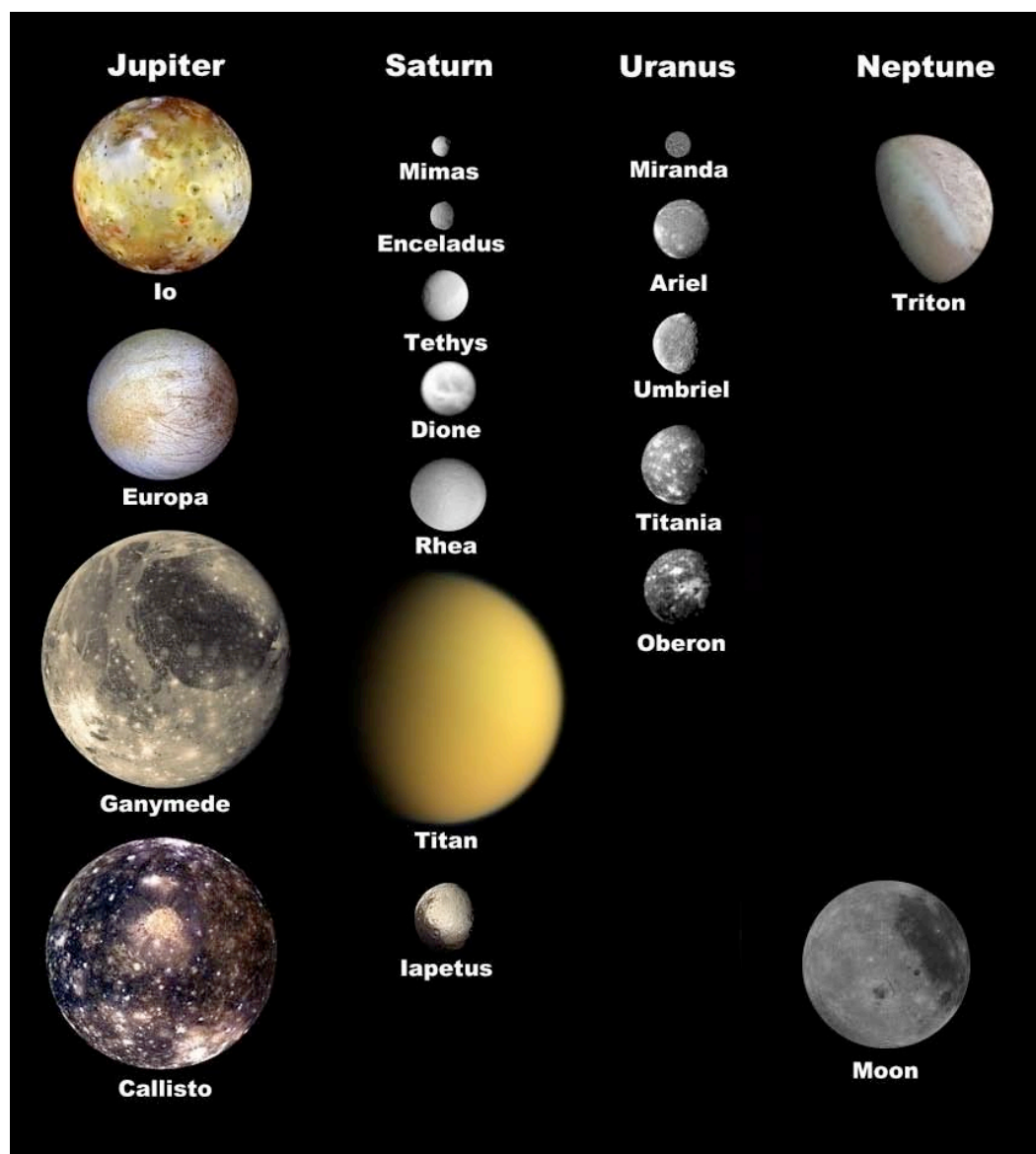

FIGURE 8.1 Montage of the major outer planet satellites, with Earth’s Moon for scale. Ganymede’s diameter is 5262 km. The Moon’s diameter is 3476 km. SOURCE: NASA.

All three of the crosscutting science themes for the exploration of the solar system motivate further exploration of the outer planet satellites; their study is vital to addressing many of the priority questions in each of the themes. For example, in the Building New Worlds theme, the satellites retain chemical and geological records of the processes of formation and evolution in the outer solar system—records no longer accessible in the giant planets themselves. As such the satellites are key to attacking the question “how did the giant planets and their satellite systems accrete, and is there evidence that they migrated to new orbital positions?” The Planetary Habitats theme includes the question “what were the primordial sources of organic matter, and where does organic synthesis continue today?” The surfaces and interiors of the icy satellites display a rich variety of organic molecules—some believed to be primordial, some likely being generated even today; Titan presents perhaps the richest planetary laboratory for studying organic synthesis ongoing on a global scale. Europa, Enceladus, and Titan are central to another key question in this theme: “beyond Earth, are there modern habitats elsewhere in the solar system with necessary conditions, organic matter, water, energy, and nutrients to sustain life, and do

organisms live there now?” Titan’s complex atmosphere exhibiting a global methane cycle akin to Earth’s hydrological cycle is key to the understanding the Workings of the Solar System theme and the question “can understanding the roles of physics, chemistry, geology, and dynamics in driving planetary atmospheres and climates lead to a better understanding of climate change on Earth?” Finally, the giant planet satellites exhibit an enormous spectrum of planetary conditions, chemistry, and processes—contrasting those of the inner solar system and stretching our scientific imaginations in “how have the myriad chemical and physical processes that shaped the solar system operated, interacted, and evolved over time?”

SCIENCE GOALS FOR STUDIES OF PLANETARY SATELLITES

The planetary science community has made remarkable progress over the past decade in understanding the major satellites of the giant planets (Table 8.2), but despite this progress, important questions remain unanswered. The committee has developed some specific high-level goals and associated objectives to guide the continued advancement of the study of planetary satellites. The goals cover the broad areas of origin and evolution, processes, and habitability. They are as follows:

- How did the satellites of the outer solar system form and evolve?
- What processes control the present-day behavior of these bodies?
- What are the processes that result in habitable environments?

Each of these goals is described in more details in subsequent sections.

TABLE 8.2 Major Accomplishments by Ground- and Space-based Studies of the Satellites of the Giant Planets in the Past Decade

Major Accomplishments	Mission and/or Techniques
Discovered an active meteorological cycle on Titan, involving liquid hydrocarbons instead of water.	Cassini and Huygens; ground-based observations.
Discovered endogenic activity on Enceladus, and found that the Enceladus plumes have a major impact on the saturnian environment.	Cassini
Greatly improved our understanding of the origin and evolution of Titan’s atmosphere and volatile inventory, and its complex organic chemistry.	Theory and modeling based on Cassini and Huygens’ data
Major improvement in characterizing the processes, composition and histories for all the saturnian satellites.	Theory and modeling based on Cassini data
Developed new models improving our understanding of Europa, Io, and the other Galilean satellites.	Theory and modeling based on Galileo data; ground-based observations; and Cassini and New Horizons.

HOW DID THE SATELLITES OF THE OUTER SOLAR SYSTEM FORM AND EVOLVE?

Understanding the origin and evolution of the satellites is a key goal of satellite exploration. Satellite composition and internal structure (particularly the state of differentiation), provide important clues to the formation of these worlds and their parent planet, and the origin and evolution of volatile species are of particular interest. Orbital evolution, and its intimate connections to tidal heating, provides

a major influence on satellite evolution. Tidal and other energy sources drive a wide range of geological processes, whose history is recorded on the satellite surfaces.

Objectives associated with goal of understanding the formation and evolution of the giant planet satellites include the following:

- What were conditions during satellite formation?
- What determines the abundance and composition of satellite volatiles?
- How are satellite thermal and orbital evolution and internal structure related?
- What is the diversity of geological activity and how has it changed over time?

Subsequent sections examine each of these objectives in turn, identifying important questions to be addressed and future investigations and measurements that could provide answers.

What Were Conditions During Satellite Formation?

The properties of the existing regular satellite systems provide clues about the conditions in which they formed. The regular satellites of Jupiter, Saturn, and Uranus orbit in the same planes as the planets' equators, suggesting that the moons likely formed in an accretion disk in the late stages of planet formation.¹ Neptune has one large irregular satellite, Triton, in an inclined and retrograde orbit (opposite from the direction of Neptune's rotation). Triton may be a captured Kuiper belt object, and moons that might have formed in a neptunian accretion disk were probably destroyed during the capture. Each of the regular systems has unique characteristics. Jupiter has four large satellites (the Galilean satellites), the inner two of which are essentially rocky bodies while the outer two moons are rich in ice. The saturnian system has a single large satellite, while closer to Saturn there are much smaller, comparably sized icy moons. The regular uranian satellites lie in the planet's equatorial plane that is tilted by 97° to the ecliptic (i.e., the plane of Earth's orbit).

The outer planet satellites have also been modified by endogenic (e.g., internal differentiation and tides) and exogenic (e.g., large impacts) processes that have strongly influenced what is seen today. While the present orbital dynamical, physical and chemical states of the satellites preserve information about their origins, this can be hidden or erased by processes taking place during the evolution of the moons.

The Cassini mission has opened our eyes to the wonders of the saturnian satellites. Titan's surface is alive with fluvial and aeolian activity,² yet its interior is only partially differentiated,³ has no magnetic field, and probably no metallic core. On tiny Enceladus, water vapor plumes have been discovered emanating from south polar fissures, warmed by an unusual amount of internal heat.⁴ These observations together with the satellite's density have important implications for the interior of Enceladus that in turn impose limitations on its formation and evolution. Iapetus is remarkably oblate for its size, and its ancient surface features a unique equatorial belt of mountains, providing unique constraints on its early history. Cassini observations of the other saturnian moons—Rhea, Dione, Mimas and Tethys—have increased our knowledge of their surfaces, compositions, and bulk properties.

Measurements of volatile abundances are enabling the reconstruction of the planetesimal conditions at the time of accretion of the satellites, but this is still far from understood. Titan's dense atmosphere makes it especially interesting: The dominance of molecular nitrogen and the absence of the expected accompanying abundance of primordial argon is an important result that constrains origin.⁵

Important Questions

Some important questions concerning the conditions during satellite formation include the following:

- Why are Titan and Callisto apparently imperfectly differentiated whereas Ganymede underwent complete differentiation?
- Why did Ganymede form an iron-rich core capable of sustaining a magnetic dynamo?
- What aspects of formation conditions governed the bulk composition and subsequent evolution of Io and Europa?
 - In what ways did the formation conditions of the saturnian satellites differ from the conditions for the jovian satellites?
 - Can we discern any evidence in the uranian satellites of a very different origin scenario (a giant impact on Uranus for example) or is this satellite system also the outcome of a process analogous to the other giant planet satellite origins?
 - What features of Triton are indicative of its origin?

Future Directions for Investigations and Measurements

A key investigation to understanding the conditions during satellite formation is to establish the thermodynamic conditions of satellite formation and evolution. This requires determination of the bulk compositions and isotopic abundances. These results would directly constrain conditions of formation, for example the radial temperature profile in the planetary accretion disk from which the regular satellites formed. Two other crucial areas are to better constrain the internal mass distributions of many of the satellites by measuring the static gravitational fields and topography and to probe the existence and nature of internal oceans by measurements of tidal variations in gravity and topography and by measurements of electromagnetic induction in the satellites at multiple frequencies. Internal oceans may date to a satellite's earliest history, as they can be difficult to re-melt tidally once frozen, and thus their presence constrains formation scenarios.

What Determines the Abundance and Composition of Satellite Volatiles?

Volatiles on the outer planet satellites are mainly contained in ices, although volatiles can also be retained in the rocky components (e.g., hydrated silicates on Europa or Io). Clathration (i.e., the incorporation of gas molecules within a modified water-ice structure) is a likely process for retention of many volatiles in satellite interiors, and it helps to explain the current composition of Titan.⁶ Alternatives like trapping of gases in amorphous ice have also been suggested.

The building blocks for the satellites may have originated from the solar nebula or formed in the planetary subnebula.⁷ In either case, the thermodynamic conditions and composition of the gas phase determine the formation conditions of ices.

Huygens probe results and Cassini results have motivated a great deal of modeling of the formation conditions for the Saturn system and Titan in particular. Planetesimal formation in the solar nebula with only modest subnebula processing may be representative of the satellite formation process in the Saturn system,⁵ and clathration may have had an important role, presumably aided by collisions between planetesimals to expose “fresh” ice. This may be different from the Galilean satellites where extensive processing in the jovian subnebula may have occurred. However, the formation conditions of the Galilean satellites are not well constrained at this time, due to the lack of measurements of volatiles for these satellites including noble gases and their stable isotopes. The origin and evolution of methane on Titan is receiving much attention, with some workers favoring ongoing outgassing from the interior to balance the continual destruction over geologic time. The argon content of the atmosphere implies that nitrogen arrived as ammonia instead of molecular nitrogen; yet how ammonia evolved into molecular nitrogen is unknown.

Ground-based spectroscopy continues to expand our knowledge of volatile inventories on satellite surfaces, for instance with the discovery of carbon dioxide ice on the uranian satellites.⁸

Important Questions

Some important questions concerning the abundance and composition of satellite volatiles include the following

- In what ways do the highly volatile constituents differ between Callisto and Ganymede?
- Are volatiles present at the surface or in the ice shell of Europa that are indicative of internal processing or resurfacing?
- How, and to what extent, have volatiles been lost from Io?
- What does the plume material from Enceladus tell us about the volatile inventory of that body?
- Why does Titan uniquely have an exceptionally thick atmosphere?
- What does the volatile inventory of Titan tell us about its history? In particular, how is the methane resupplied, given its rapid photochemical destruction in the upper atmosphere?

Future Directions for Investigations and Measurements

Investigations and measurements relevant to the abundance and composition of satellite volatiles include determination of the volatile composition of the ices, the stable isotope ratios of carbon, hydrogen, oxygen, and nitrogen, and the abundances of the noble gases to help untangle nebula and subnebula processes using highly precise remote and in situ determinations of atmospheric and surface compositions; improved observations of currently active volatile loss processes; and improved understanding of the thermodynamics of volatiles and the efficiency of clathration of volatiles as a function of the formation conditions.

How are Satellite Thermal and Orbital Evolution and Internal Structure Related?

Like planets, satellite structure and evolution are strongly affected by mass and composition. Unlike planets, satellites are very close to the central body and can therefore be greatly affected by tides and tidally mediated resonances (periodic mutual gravitational interactions).⁹ This leads to a rich diversity of outcomes (Figure. 8.2), whose understanding can tell us about the history of the system as well as about the satellite internal structure. At least three bodies (Io, Europa, and Enceladus) are thought to be currently undergoing large tidal heating and others (Ganymede, Triton, possibly Titan, and maybe more) may have been heated this way in the past. Tidal effects are ultimately limited by orbital evolution and the energy budget this allows. Unlike radiogenic heating caused by energy released from radioactive substances, the magnitude, spatial and temporal variability of tidal heating are very sensitive to the structure of the satellite. Evolution of the internal structure of the satellite is also affected by the radiogenic heating of the rocky component, and this alone will guarantee convection in the ice-rich parts of the larger satellites.¹⁰ Convection can in turn drive surface tectonics and may cause outgassing or cryovolcanism.

Although Enceladus was already recognized at the time of the last planetary decadal survey as a likely location of tidal heating, it has emerged as an active body of great interest, primarily through Cassini observations. The plume activity and estimates of thermal emission imply a level of tidal heating that is unexpectedly high for a body so small. Enceladus's forced eccentricity and tidal heating may not be constant through geologic time.¹¹ Meanwhile, progress has continued on a more complete understanding of Io and Europa, through continued analysis of Galileo data combined with ground-based and Earth orbit telescopic observations. Recent work appears to support the idea that Io is in thermal but not orbital equilibrium.¹² Cassini gravity data suggest that Titan is not fully differentiated,¹³ perhaps like

Callisto but unlike Ganymede. This mainly elucidates formation conditions, but it may also inform about tidal heating in Ganymede or the role of later impacts.

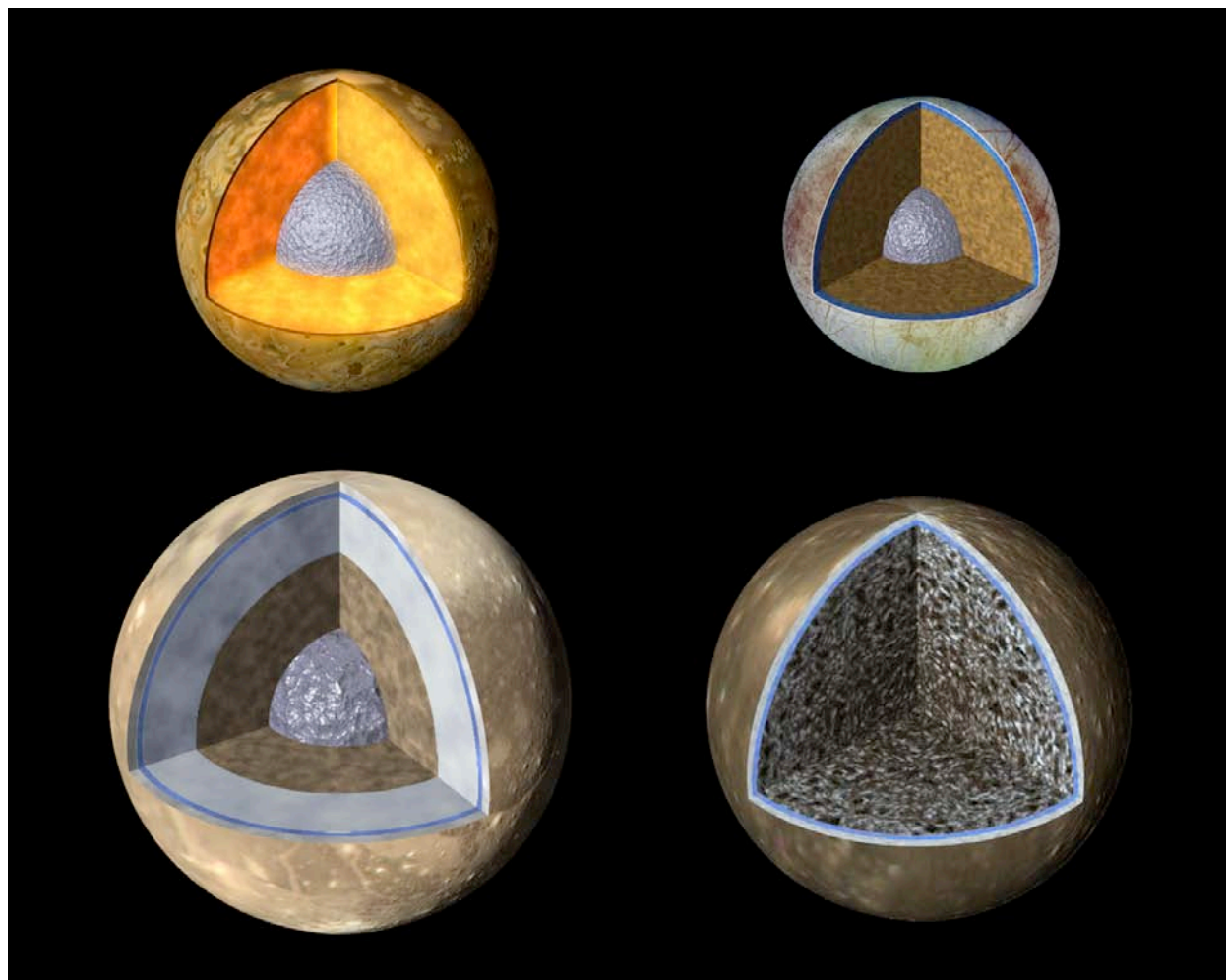

FIGURE 8.2 Schematic of the highly diverse interiors of the Galilean satellites, inferred from Galileo data. Io (upper left), Europa (upper right), and Ganymede (lower left) have metallic cores surrounded by silicate mantles which, in the case of Europa and Ganymede, are overlain by water ice and subsurface oceans (blue). Europa's ocean, unlike Ganymede's, is in contact with the underlying silicate mantle. Callisto (lower right) also hosts an ocean, but is only partially differentiated, and its interior consists primarily of mixed silicates and ice. Ganymede's diameter is 5262 km. SOURCE: NASA/JPL.

Important Questions

Some important questions about the satellite thermal and orbital evolution of satellites and how it relates to their internal structure include the following:

- What is the history of the resonances responsible for the tidal heating and how is this heating accomplished?
 - How does this heat escape to the surface?
 - How is this heat transfer related to the internal structure (thickness of an outer solid shell, or composition of the interior) and formation?

- How hydrostatic are the satellites?

There are also body-specific questions:

- Does Io have a magma ocean and what is the compositional range of its magmas?
- What is the origin of the topography of Io?
- What is the magnitude and spatial distribution of Io's total heat flow?
- What are the thickness of Europa's outer ice shell and the depth of its ocean?
- What is the magnitude of Europa's tidal dissipation, and how is it partitioned between the silicate interior and the ice shell?
- What is the relationship between Titan's surface morphology and internal processes, particularly for the history of the methane budget and lakes or seas and possible replenishment of methane from the interior or subsurface?
- Does Titan have an internal liquid water ocean?
- What is the spatial distribution of Enceladus's heat output, and how has it varied with time?
- Does Enceladus have an ocean or some other means of providing large tidal dissipation, and to what extent is its behavior dictated by its formation conditions (e.g., presence or absence of a differentiated core?)
- What does the diversity of the uranian moons tell us about the evolution of small to medium-sized icy satellites? What drove such dramatic endogenic activity on Miranda and Ariel?
- What powers past or possible ongoing activity on Triton, which currently has negligible tidal heating?

Future Directions for Investigations and Measurements

Many of the future investigations needed to understand formation arise here as well because of the interplay of formation conditions and subsequent thermal evolution. A better understanding of the internal structure and thermal evolution requires measurements of static gravitational fields and topography to probe interior structure and of tidal variations in gravity and topography, as well as electromagnetic induction in the satellites at multiple frequencies to search for oceans. The presence and nature of intrinsic magnetic fields also constrain internal thermal evolution and initial conditions. Another needed key investigation is subsurface sounding (e.g., radar), to investigate the structure of the upper lithosphere. Heat flow can be sufficiently large to be detected through thermal infrared techniques. This provides a powerful constraint on the satellite's thermal state. Improved maps of composition and geology of the satellite surfaces will constrain the extent and nature of transport of heat from the interior. Critical to interpretations from these investigations are improved laboratory determinations of the thermophysical and mechanical properties of relevant candidate materials to better constrain interior processes.

What is the Diversity of Geological Activity and How has it Changed Over Time?

The surfaces of solar system bodies provide important clues to their history and evolution. Collectively, outer planet satellites show the scars of almost every surface process, including impact cratering, tectonic deformation, cryovolcanism, and aeolian and fluvial erosion. Many of these processes are still mysterious. Icy-satellite tectonism is often extensional,¹⁴ sometimes bringing interior materials up to the surface, but strike-slip faulting is also observed. Compressive tectonism is less evident on icy satellites; however, it is likely responsible for Io's towering mountains.¹⁵ Much of Europa's surface is disrupted by extensive and mysterious chaos regions.¹⁶ Solid-state convection is likely to be an important driver of icy satellite geology, but details are unclear. The large range of ages and processes provides a

valuable window into solar system history, constraining thermal and compositional evolution and allowing a better understanding of how planetary systems form and evolve.

The science return from the Cassini mission has been phenomenal. Multiple flybys of Titan have confirmed the presence of numerous methane lakes on the surface—the only bodies of surface liquid on any known world other than Earth—along with fluvial channels (Figure 8.3), and evidence for seasonal variations.¹⁷ Images of Enceladus reveal a long and complex geological history that continues to the present day, and includes ridges that are morphologically similar to Europa’s ubiquitous double ridges.¹⁸ Wispy features on Dione and Rhea’s trailing hemisphere have been revealed to be huge cliffs, evidence of a tectonically active past.¹⁹ Images of Iapetus show an ancient equatorial belt of mountains, a remnant of Iapetus’s early evolution. Cassini images have shown unusual impact crater morphologies on Hyperion. Continued analysis of Galileo images has constrained the population of primary and secondary impactors in the outer solar system,²⁰ and provides continued new insights into the remarkable geology of Europa.

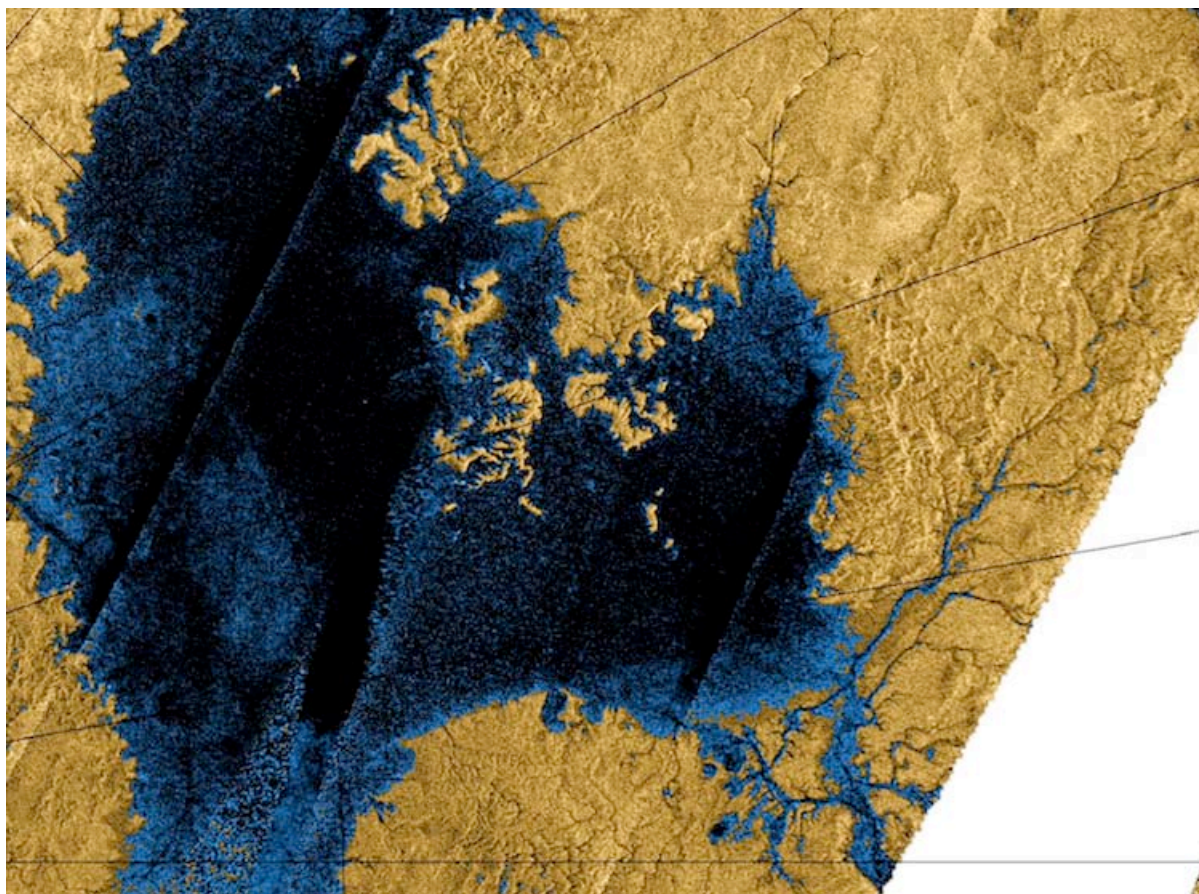

FIGURE 8.3 False color Cassini radar image of a methane sea near Titan’s north pole, fed by dendritic drainage channels. The image is 360 kilometers from top to bottom. SOURCE: NASA/JPL/USGS.

Important Questions

Some important questions about the diversity of geological activity and how it has changed over time include the following:

- One of the key missing pieces in our understanding of satellite surface geology is adequate knowledge of the cratering record in the outer solar system.²¹ What are the impactor populations in the outer solar system, and how have they changed over time, and what is the role of secondary cratering?
 - What are the origins of tectonic patterns on Europa, including the ubiquitous double ridges (Figure 8.4) and chaos regions?
 - How much non-synchronous rotation has Europa's ice shell undergone, and how have the resulting stresses manifested at the surface?
 - How is contraction accommodated on Europa?
 - Has material from a subsurface Europa ocean been transported to the surface, and if so, how?
 - What caused Ganymede's surface to be partially disrupted to form grooved terrain, and is the grooved terrain purely tectonic or partly cryovolcanic in origin?
 - Did Ganymede suffer a late heavy bombardment that affected its appearance and internal evolution?
 - What is the age of Titan's surface, and have cryovolcanism and tectonism been important processes? Have there been secular changes in the surface methane inventory?
 - Why is Enceladus's geology so spatially variable, and how has activity varied with time?
 - What geological processes have created the surfaces of the diverse uranian moons, particularly the dramatic tectonics of Miranda and Ariel?
 - Has viscous extrusive cryovolcanism occurred on icy satellites, as suggested by features on Ariel and Titan?
 - What geological processes operate on Triton's unique surface, how old is that activity, and what do its surface features reveal about whether it is captured?

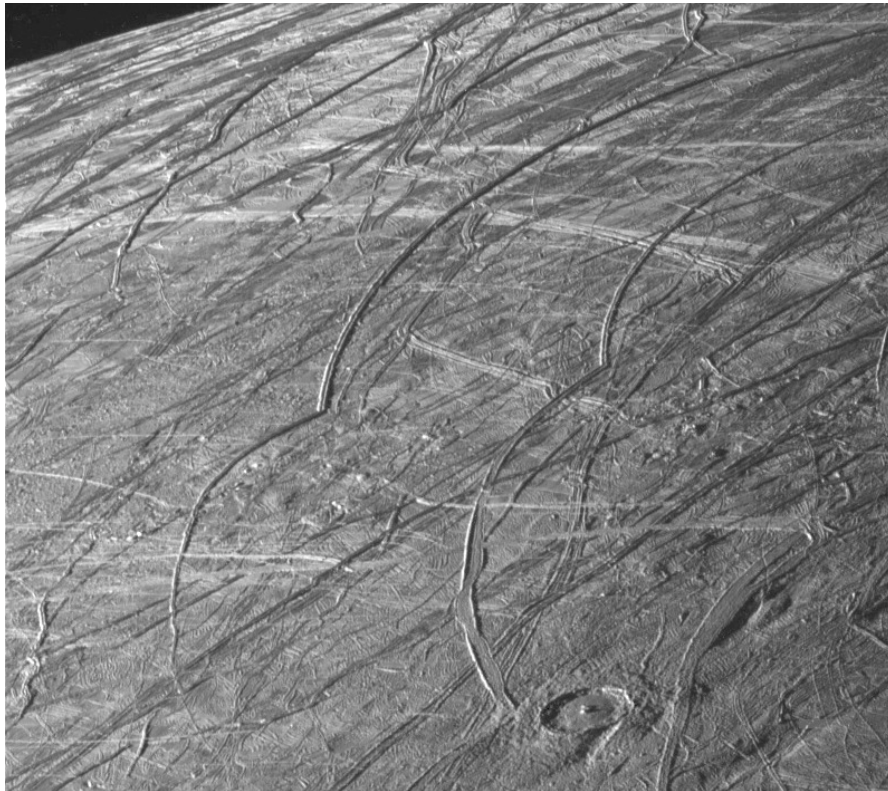

FIGURE 8.4 Cycloid ridges on Europa, seen by Galileo in 1998. The plan form of these ridges probably results from diurnal variations in tidal stresses, placing limits on the strength of the ice shell, but the reason why the ridges are double, like so many on Europa, remains mysterious. The image is about 150 km across. SOURCE: NASA/JPL.

Future Directions for Investigations and Measurements

Advancing our understand of the full range of surface processes operative on outer planet satellites requires global reconnaissance with 100-meter scale imaging of key objects, particularly Europa, Titan and Enceladus as well as topographic data and high-resolution mapping (~10 meters/pixel) of selected targets to understand details of their formation and structure. In particular, understanding of tidally induced tectonics requires such global maps. Improved knowledge about subsurface structure is essential to constrain the nature and extent of endogenic geologic processes, for example the lithospheric thickness, fault penetration depths, porosity, thermal structure, and the presence of subsurface liquid. Maps of compositional variations at high spatial and spectral resolution and over a broad range of wavelengths are key to understand how surface materials are emplaced and evolve. Critical to accurate interpretation of such spacecraft data are better laboratory reflectance and emission spectra of materials relevant to the outer solar system (some of which do not exist at standard temperature and pressure). A comprehensive spectral database of ices and minerals covering a wide temperature range would have wide-ranging applications to outer solar system satellites.

WHAT PROCESSES CONTROL THE PRESENT-DAY BEHAVIOR OF THESE BODIES?

Many planetary satellites are highly dynamic, alive with geological and/or atmospheric activity, and even the more sedate moons have active chemical and physical interactions with the plasma and radiation environments that surround them. Study of these active processes provides an invaluable opportunity to understand how planetary bodies work.

Important objectives include the following:

- How do active endogenic processes shape the satellites' surfaces and influence their interiors?
- What processes control the chemistry and dynamics of satellite atmospheres?
- How do exogenic processes modify these bodies?
- How do satellites influence their own magnetospheres and those of their parent planets?

Subsequent sections examine each of these objectives in turn, identifying key questions to be addressed and future investigations and measurements that could provide answers.

How Do Active Endogenic Processes Shape the Satellites' Surfaces and Influence Their Interiors?

Watching active geology as it happens provides unique insights into planetary processes that can be applied to less active worlds. Active endogenic geologic processes, both volcanic and tectonic, can be observed directly on Io and Enceladus, and Europa's low crater density implies that ongoing activity is also plausible there. An isolated active region on Europa comparable in size to Enceladus's south polar province could easily have been missed by previous missions. Evidence for ongoing endogenic activity on Titan has been suggested, and Triton's plumes may be driven by ongoing endogenic processes.²²

Cassini measurements have revealed active cryovolcanism on Enceladus, which provides a window into its interior structure and composition and provides a case study for tidal heating of icy satellites (Figure 8.5). Associated tectonic and other resurfacing activity is seen along and near the tiger stripes (the active geological features near Enceladus's south pole), shedding light on the origin of similar double ridges on Europa.²³ Cassini images of Titan's surface show many enigmatic features, some of which may result from active cryovolcanism. The source of the current atmospheric methane which should be destroyed on geologically short timescales remains problematic, and cryovolcanic supply remains plausible.²⁴

At Jupiter, the Pluto-bound New Horizons spacecraft demonstrated the potential of high data rates and sensitive instrumentation for illuminating active volcanic processes on Io, capturing spectacular images and movies of its volcanic plumes (Figure 8.7).²⁵

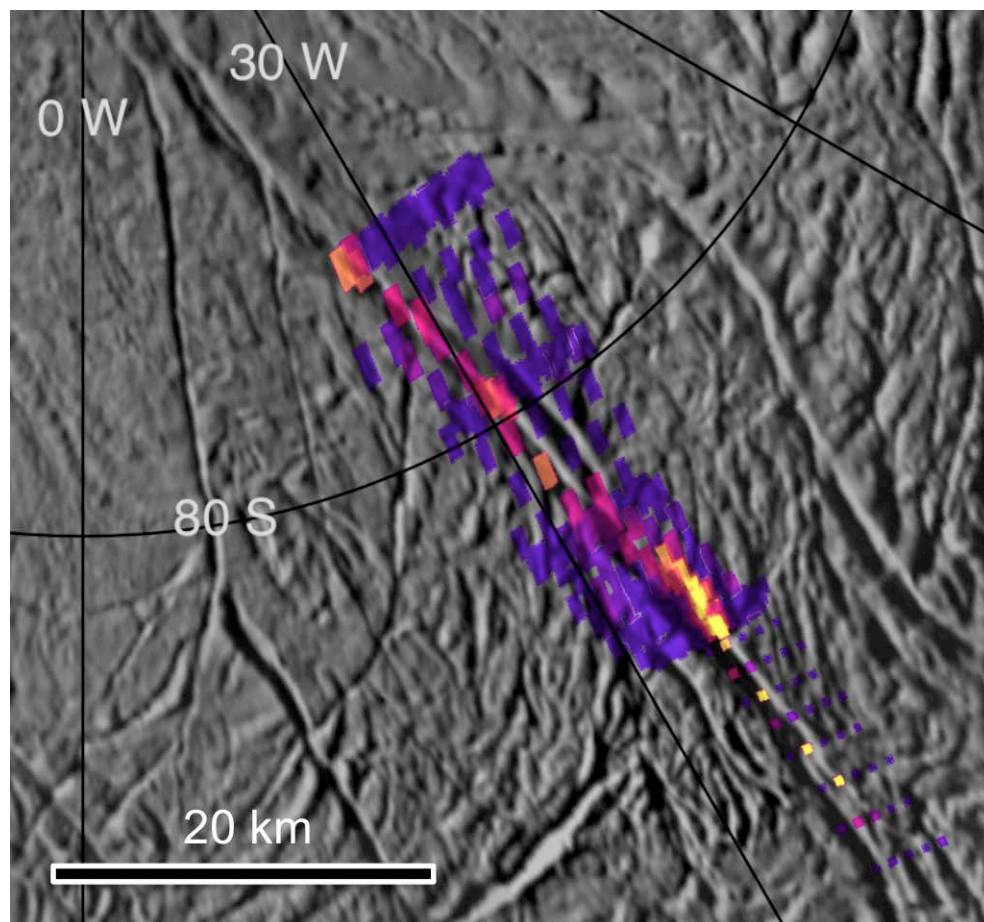

FIGURE 8.5 Thermal emission from a small part of Baghdad Sulcus, a “tiger stripe” fissure near Enceladus’s south pole, seen by Cassini at a wavelength of 9-16 μm in 2009. Thermal emission intensity is color coded from blue (negligible) to yellow (most intense). Inferred surface temperatures exceed 180 K. SOURCE: NASA/JPL/GSFC/SwRI/SSI.

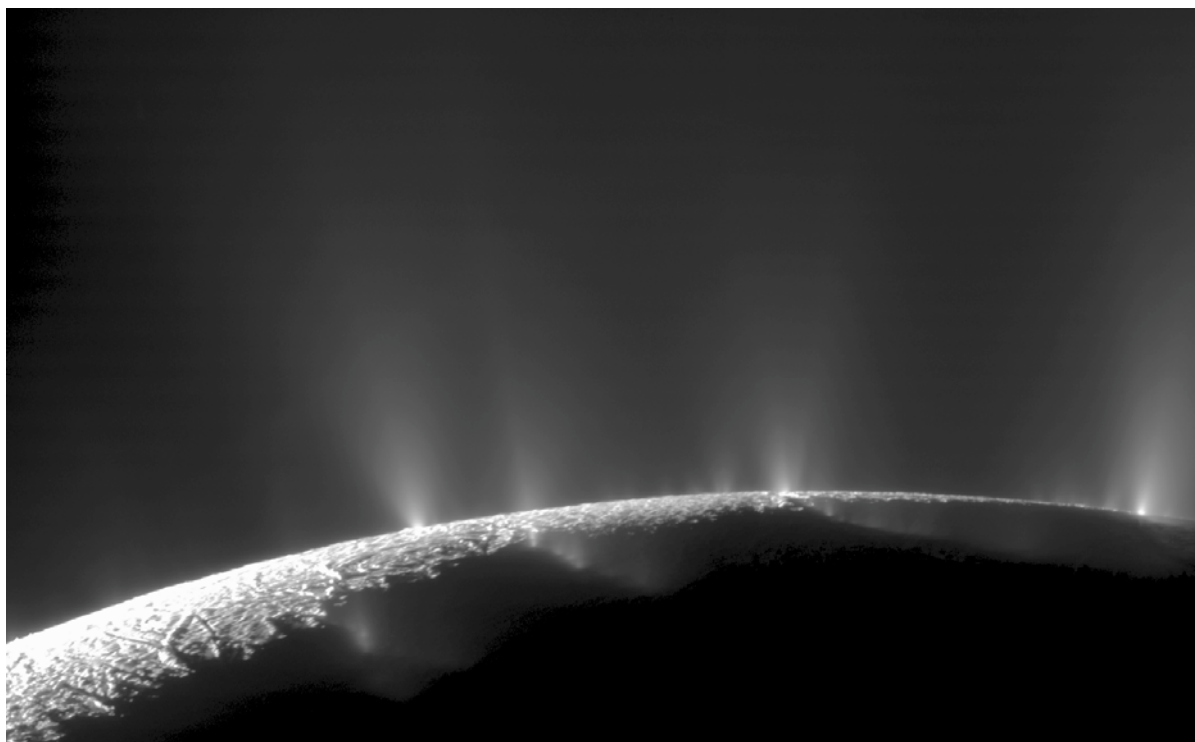

FIGURE 8.6 Multiple jets, dominated by water vapor and ice particles, but containing a rich mixture of other compounds, emanate from the active warm fractures at Enceladus's south pole. This Cassini image is 130 km across. SOURCE: NASA/JPL/SSI.

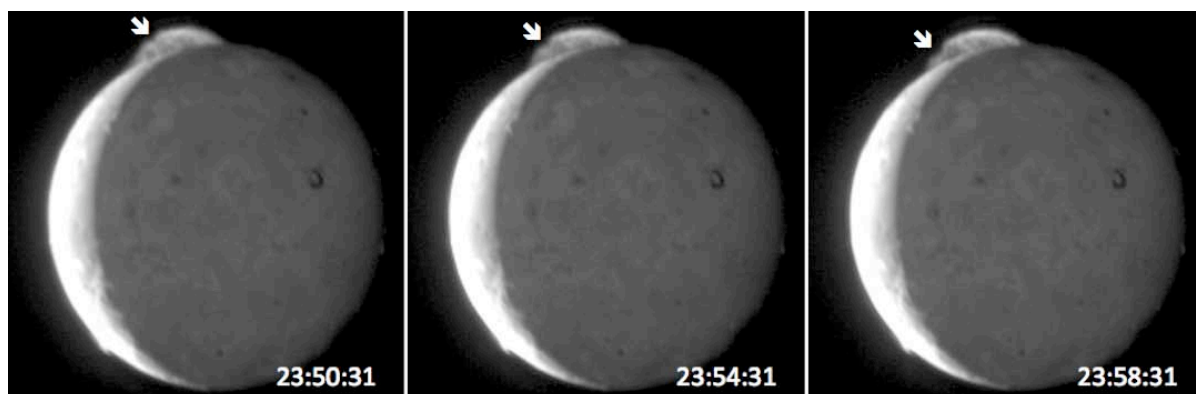

FIGURE 8.7 Three frames from a movie of Io's Tvashtar plume, showing plume motion on minute timescales, taken by the New Horizons during its 2007 Jupiter flyby. Motion of one feature in the plume is highlighted by the arrows. Io's diameter is 3642 kilometers. SOURCE: NASA/APL/SwRI.

Important Questions

Much remains to be learned about active volcanic and tectonic processes. Some important questions include the following:

- What mechanisms drive and sustain Enceladus's plumes and active tiger stripe tectonics?
- What are the magnitude, spatial distribution, temporal variability, and dissipation mechanisms of tidal heating within Io, Europa, and Enceladus?

PREPUBLICATION COPY—SUBJECT TO FURTHER EDITORIAL CORRECTION

8-14

- Is there active cryovolcanism on Titan?
- What are the eruption mechanisms for Io's lavas and plumes and their implications for volcanic processes on early and modern Earth?

Future Directions for Investigations and Measurements

Key investigations and measurements into active tectonic and volcanic processes include 1) exploration of Io's dynamic volcanism in the temporal domain at high spatial resolution, over timescales ranging from minutes (for the dynamics of active plumes), to weeks or decades (for the evolution of lava flows and volcanic centers), 2) global maps of Titan's surface morphology and surface composition to search for evidence for present-day geological activity, and 3) acquisition of higher-resolution thermal and visible imaging of the active south pole of Enceladus, including temporal coverage, to elucidate plume generation mechanisms. Other important objectives include search for activity on other satellites such as Europa by looking for thermal anomalies, gas and dust plumes, or surface changes and collection of additional in situ measurements of the composition of the endogenic materials lofted into the atmospheres or plumes of these satellites.

What Processes Control the Chemistry and Dynamics of Satellite Atmospheres?

Satellite atmospheres are exceptionally varied (Table 8.1), and a great range of processes governs their structures, chemistries and dynamics. Surface pressures range 12 orders of magnitude, from picobars to 1.5 bar (~1.5 times Earth's surface pressure). The thinnest atmospheres, including those of Europa, Ganymede, and probably Callisto, are created by sputtering (i.e., ejection of particles from the surface by plasma bombardment) and are dominated by oxygen molecules which are too sparse to interact significantly with each other.²⁶ Io's patchy atmosphere, dominated by sulfur dioxide, results from a combination of volcanic supply and surface frost evaporation,²⁷ while Triton's denser global molecular nitrogen-dominated atmosphere is entirely supported by evaporation of surface frosts.

Ground-based observations have furthered understanding of the distribution of the atmosphere-supporting molecular nitrogen and methane frosts over the surface of Triton.²⁸ Ground-based and Hubble Space Telescope observations have demonstrated that Io's atmosphere is concentrated in the equatorial regions and shows stable 10-fold variations in density with longitude.²⁹

By far the largest satellite atmosphere is Titan's, dominated by nitrogen molecules, which dwarfs Earth's atmosphere, and originated from the outgassing of volatiles during its formation, continuing into at least the recent past. Titan's atmosphere experiences a range of dynamical and chemical processes.³⁰ (Figure 8.8). The second most abundant constituent, methane, exists as a gas, liquid and solid, and cycles from the surface to the atmosphere, with clouds, rain and lakes. The temperature profile manifests greenhouse warming and "anti-greenhouse" cooling. The dynamics of Titan's atmosphere ranges in scale from global circulation patterns to local methane storms. Titan's atmospheric composition is affected primarily by dissociation of methane and nitrogen by solar ultraviolet radiation and by magnetospheric electrons, which leads to a complex chemistry that extends from the ionosphere down to the surface.

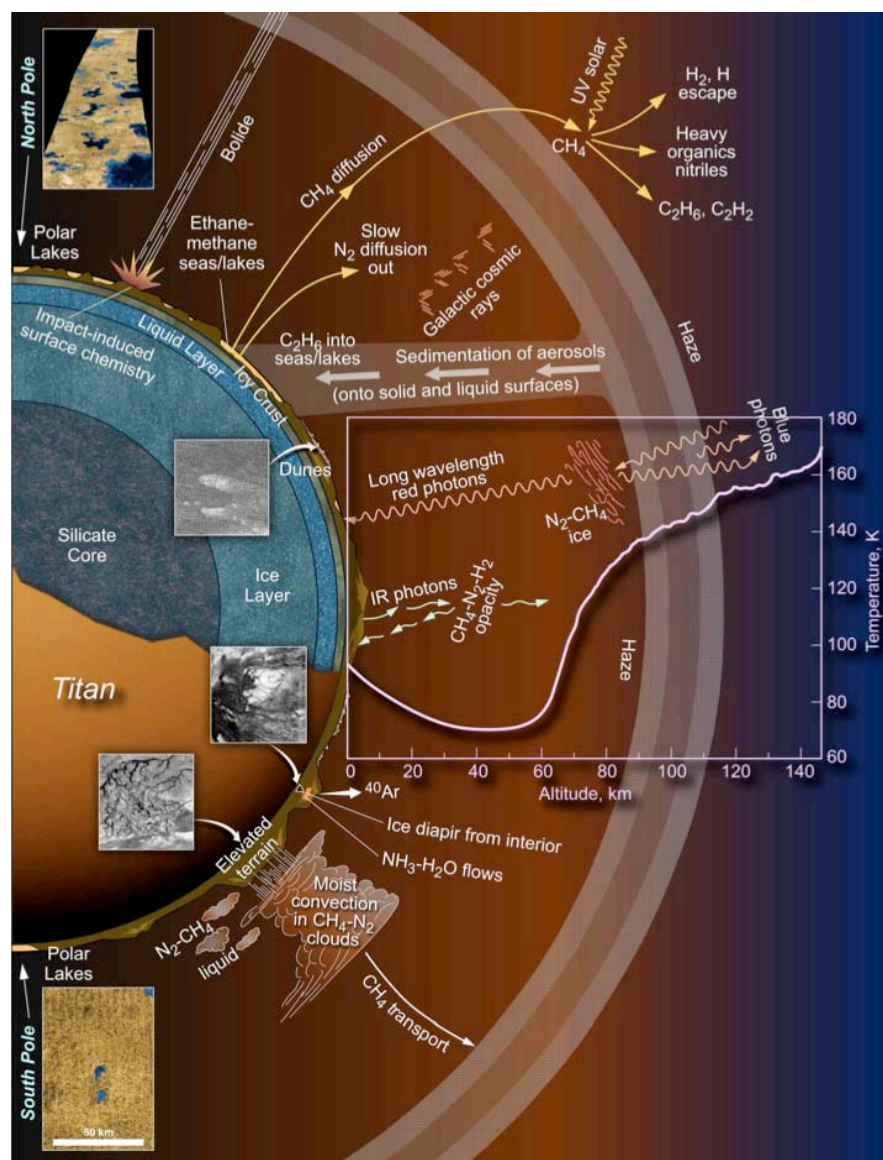

FIGURE 8.8 Schematic of the complexities of atmospheric processes on Titan, and their relationship to its surface and interior. SOURCE: NASA and ESA, *Titan Saturn System Mission (TSSM) NASA/ESA Joint Summary Report*, January 19, 2009. Courtesy of NASA/ESA.

Measurements by Cassini and Huygens, complemented by ground-based observations, have revolutionized understanding of Titan's atmosphere. Cassini and ground-based telescopes have begun to characterize the seasonal variations in Titan's clouds and circulation patterns, for example recently observing the appearance of equatorial clouds at the beginning of northern spring, and Cassini has revealed surface terrains shaped by rain, rivers and wind, which point to weather processes similar to those on Earth with convection, evaporation and rainfall. Cassini measurements have also revealed that Titan's ion chemistry and photochemistry produces a multitude of heavy organic molecules, likely containing amino acids and nucleotides.

Important Questions

Some important questions concerning the chemistry and dynamics of satellite atmospheres include the following:

PREPUBLICATION COPY—SUBJECT TO FURTHER EDITORIAL CORRECTION

- What is the temporal and spatial variability of the density and composition of Io's atmosphere, how is it controlled, and how is it affected by changes in volcanic activity?
- What are the relative roles of sublimation, molecular transport, sputtering and active venting in generating tenuous satellite atmospheres?
 - Do the large organic molecules detected by Cassini in Titan's haze contain amino acids, nucleotides and other pre-biotic molecules?
 - What processes control Titan's weather?
 - What processes control the exchange of methane between Titan's surface and the atmosphere?
 - Are Titan's lakes fed primarily by rain or by underground methane-ethane "aquifers"?
 - How do Titan's clouds originate and evolve?
 - What is the temperature and opacity structure of Titan's polar atmosphere, and what is its role in Titan's general circulation?
 - What is Triton's surface distribution of molecular nitrogen and methane, and how does it interact with the atmospheric composition and dynamics?

Future Directions for Investigations and Measurements

Improved understanding of the chemistry and dynamics of Io's atmosphere will require improved mapping of the spatial distribution and temporal variability of its atmosphere and associated correlations with local time and volcanic activity as well as measurement of the diurnal variation in frost temperatures; and direct sampling of the atmosphere to determine composition. New advances in characterizing the tenuous atmospheres of the icy Galilean and saturnian satellites can be achieved by direct sampling from flybys and, where possible, by their ultraviolet emissions.

Continued observations of seasonal changes on Titan will be vital to understanding the dynamics of its atmosphere and its interaction with the surface. Improved understanding of its organic chemistry will require in situ atmospheric compositional measurements capable of characterizing complex organic molecules. New insights into atmosphere/surface interactions and energy balance on Titan will require global and regional morphological and compositional mapping of the surface as well as measurements of lake composition and evaporation processes. Future measurements of the vertical structure of Titan's hazes and clouds, their densities and particle sizes and shapes are needed to understand cloud and haze formation and evolution, particularly in the polar regions.

Advancing the exploration of Triton will require detailed surface compositional and temperature maps coupled with ultraviolet stellar and radio occultations, as well direct samples of the atmosphere from spacecraft flybys.

New laboratory data on the spectroscopy of mixtures including molecular nitrogen, methane, ethane, and propane liquid and ice, as well as methane gas at high pathlength (10^{29} m^{-2}) and low temperature ($\sim 85 \text{ K}$) are critical to understand the volatile inventory on Titan and the composition of Triton's surface and atmosphere.

How Do Exogenic Processes Modify These Bodies?

Most of the large satellites are embedded in the hot corotating plasmas of their planet's magnetospheres. The plasmas erode the surfaces of these satellites through ion sputtering and also chemically modify them through electron-induced radiolysis (radiation-driven chemistry).³¹ With the exception of Ganymede (which is protected by its own magnetic field), the trailing hemispheres of the satellites bear the brunt of the corotating plasma onslaught (Figure. 8.9). Ion sputtering results in the formation of tenuous atmospheres and even circumplanetary ion and neutral tori (such as around the

orbits of Io and Europa), and potentially allows orbital measurement of surface composition via sputtered products. Europa may lose around 2 centimeters of its surface to plasma sputtering every million years.³² Implantation of exogenic species can be significant (for instance, sulfur of likely ionian origin is found on Europa's trailing side), and radiolytic processing generates reactive species such as molecular oxygen and hydrogen peroxide in surface ices, which might, in the case of Europa or Enceladus, deliver chemical energy to underlying bodies of liquid water in quantities sufficient to power biological activity.³³

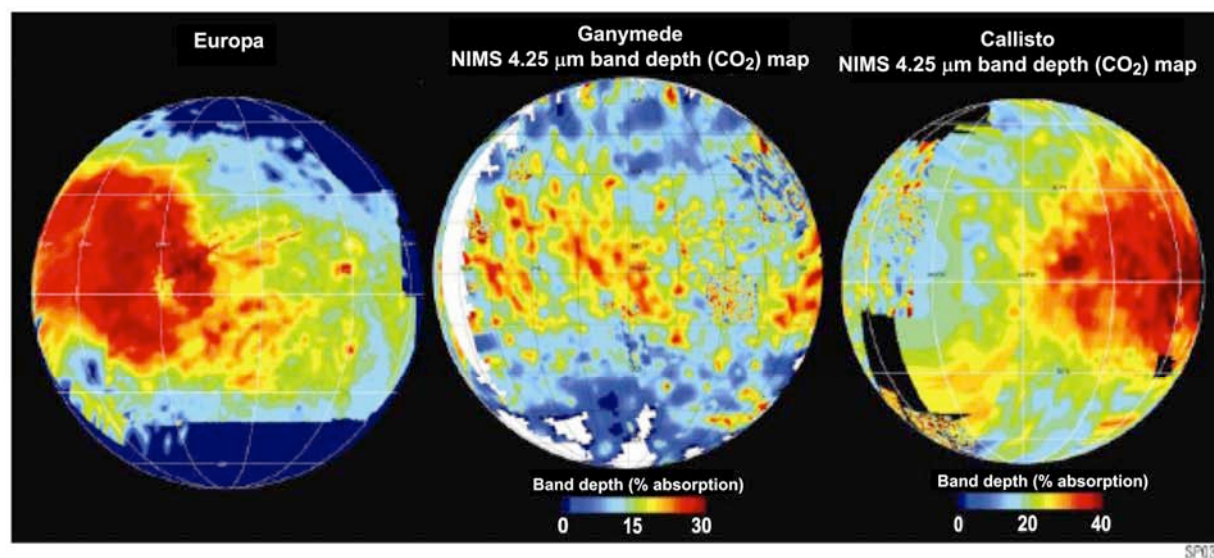

FIGURE 8.9 Near-infrared maps from the Galileo mission of non-water-ice surface materials on Europa (*left*, sulfate hydrates), Ganymede (middle, carbon dioxide), and Callisto (*right*, carbon dioxide) Red high non-water-ice abundance regions for Europa and Callisto are centered on the trailing hemispheres, consistent with expected magnetospheric effects. SOURCE: John Cooper, NASA Goddard Flight Space Center.

Micrometeoroids play a crucial role in regolith generation and in redistributing radiolytic products to the subsurface layers through impact gardening. Regolith thickness may be many meters. Impacts may eject surface dust samples to altitudes where they can be analyzed by orbiting or flyby spacecraft. Macroscopic impacts are the major landform generators on many satellites, and are powerful probes of the structure and composition of the subsurface that they penetrate. Crater populations provide information on relative ages of surface units and on the population of projectiles over time.

Solar radiation also alters planetary surfaces. Extreme ultraviolet photolysis (photon-driven chemistry) modifies surface composition (though it is dominated by particle radiation on Jupiter's moons), and solar ultraviolet radiation has a major influence on the atmospheric chemistry of Titan. Solar-driven frost sublimation is an important process in atmospheric support and the modification of surface albedo and composition.

Recent studies based on Cassini data indicate that in Saturn's magnetosphere, the loss of surface material from plasma sputtering from the icy satellites is minimal (less than a few g/s for all of the satellites). Cassini observations show that the loss rate of heavy ions from Titan due to solar and magnetospheric effects is much larger than expected, and a mass as large as the mass to the present day atmosphere may have been lost to space over the lifetime of Titan, a conclusion supported by evidence for significant nitrogen-15/nitrogen-14 fractionation.³⁴ Analysis of Cassini data from Iapetus suggests that its long-mysterious extreme albedo dichotomy results from a combination of exogenic processes (infall of dark dust and the resulting sublimation and migration of water ice), while Enceladus's plumes have influenced the albedos and leading/trailing photometric asymmetries of the inner Saturn satellites.

Important Questions

Some important questions concerning exogenic processes include the following:

- Is Io's intense magnetospheric interaction responsible for its volatile depletion?
- How is the strong ionosphere of Triton generated?
- How do exogenic processes control the distribution of chemical species on satellite surfaces?
- How are potential Europa surface biomarkers from the ocean/surface exchange degraded by the radiation environment?
- What do the crater populations on the satellites reveal about the satellites' histories and subsurface structure and about the populations of projectiles in the outer solar system and the evolution thereof?

Future Directions for Investigations and Measurements

Important investigations and measurements into exogenic processes include improved mapping of satellite surface composition to understand and separate the distributions of endogenic and exogenic materials. As most of the exogenic materials are carried between the moons by plasma processes, in situ measurements of the field and plasma environments are required to understand the relative roles of exogenic and endogenic processes in defining the surface chemistries of the moons. These measurements may also be able to discover active venting from satellites. Improved remote sensing of impact structures, including topography and subsurface sounding (e.g., to reveal melt sheets and crustal thinning), will enhance our understanding of impact processes and their effects on surface evolution. New laboratory studies should be performed to understand the effects of irradiation on ices infused with exogenic and endogenic materials. Data on bulk ices and not just thin films is important because energetic electrons and photons often travel large distances before interacting with the contact material. More laboratory data are also needed to understand how the spectral characteristics of the icy satellites are modified by ion induced sputtering, electron irradiation, micrometeoroid bombardment and energetic photon bombardment in the cold, low-pressure environments of the icy satellites.

How Do Satellites Influence Their Own Magnetospheres and Those of Their Parent Planets?

The magnetospheres of Jupiter, Saturn and Neptune (but not Uranus) derive a large fraction of their plasma and neutral content from their embedded satellites. In Jupiter's magnetosphere, Io's volcanoes deliver between 1-2 tons/s of material (mostly sulfur dioxide, sulfur, and oxygen) through Io's atmosphere to the magnetosphere, and changes in plasma density may be related to changes in volcanic activity.³⁵ Saturn's magnetosphere is dominated by material from Enceladus, as detailed below.

The plasma in Neptune's magnetosphere appears to be dominated by N^+ ions derived mainly from the atmosphere of its moon Triton. Escape of neutrals from Triton supplies a neutral torus with a peak neutral density of $\sim 400 \text{ cm}^{-3}$ near the orbit of Triton.³⁶

Ganymede's magnetosphere derives its plasma from its own sputter-generated atmosphere and also captures plasma from the magnetosphere of Jupiter. The residence time of plasma is quite short, and overall densities of charged particles are quite small.³⁷

Ground-based telescopic observations of Io's torus and the associated fast neutral nebula continue to improve understanding of how Io refills its torus and ultimately supplies plasma to Jupiter's magnetosphere. Continued analysis of Galileo and Cassini data have stressed the importance of Europa as another important source of plasma in Jupiter's magnetosphere, revealing that a neutral atomic- and molecular-hydrogen torus is present near the orbit of Europa.³⁸

Cassini has revealed that most of the material in Saturn's magnetosphere, predominantly water, hydroxyl, and oxygen, is derived from the south polar plume of Enceladus.³⁹ Unlike at Jupiter, this material is largely in a neutral rather than ionized state. Saturn's E-ring is continually resupplied by ice particles from the Enceladus plumes. Titan also loses a considerable amount of neutral material from its atmosphere, yet there is no evidence of the presence of plasma derived from Titan in the magnetosphere of Saturn.

Important Questions

Some important questions concerning how satellites influence their own magnetospheres and those of their parent planets include the following:

- Why is Jupiter's magnetosphere dominated by charged particles whereas Saturn's magnetosphere is dominated by neutral species?
- What fraction of the material in Jupiter's magnetosphere originates from Europa and other icy satellites?
- Is the reconnection in Ganymede's magnetosphere steady or patchy and bursty?
- How rapidly does Saturn's magnetosphere react to the temporal variability of Enceladus's plume?
- Do other saturnian icy satellites such as Dione and Rhea contribute measurable amount of neutrals or plasma to Saturn's magnetosphere?
- What is the nature of Triton's inferred dense neutral torus?

Future Directions for Investigations and Measurements

Important investigations and measurements to advancing understanding of how satellites influence their own magnetospheres and those of their parent planets include 1) measurement of the composition of the jovian plasma and concurrent observations of Io's volcanoes and plumes to understand the roles of Io and the icy satellites (especially Europa) in populating Jupiter's magnetosphere and 2) simultaneous multiple spacecraft measurements of the jovian system to help to address the problem of temporal versus spatial change in Jupiter's and Ganymede's magnetospheres and to enhance our understanding of how plasma populations move around in these magnetospheres. Also key are continued field and plasma measurements and monitoring of Enceladus's plume to better elucidate the roles of Enceladus and other icy satellites in populating Saturn's magnetosphere. A survey of the fields and plasmas of Neptune's magnetosphere, supplemented by low-energy neutral-atom imaging of the magnetosphere, would dramatically improve understanding of Triton's neutral torus.

WHAT ARE THE PROCESSES THAT RESULT IN HABITABLE ENVIRONMENTS?

The understanding of humanity's place in the universe is a key motivation for the exploration of the solar system in general and planetary satellites in particular. Satellites provide many of the most promising environments for the evolution of extraterrestrial life, or for understanding the processes that led to the evolution of life on our own planet. Important objectives relevant to this goal include the following:

- Where are subsurface bodies of liquid water located, and what are their characteristics and histories?
- What are the sources, sinks and evolution of organic material?
- What energy sources are available to sustain life?

PREPUBLICATION COPY—SUBJECT TO FURTHER EDITORIAL CORRECTION

- Is there evidence for life on the satellites?

Subsequent sections examine each of these objectives in turn, identifying key questions to be addressed and future investigations and measurements that could provide answers.

Where Are Subsurface Bodies of Liquid Water Located, and What Are Their Characteristics?

A fundamental requirement for habitability is the presence of liquid water. Several of the larger satellites are thought to possess at least some liquid water in their interiors.⁹ In the coming decade, two key objectives will be to further characterize the known subsurface oceans, and to determine whether other bodies also possess such oceans.

One of the key results of the Galileo mission was the use of Jupiter's tilted magnetic field to detect subsurface oceans via magnetic induction on Europa, Ganymede and Callisto.⁴⁰ However, neither the thickness nor the conductivity (and thus composition) of these oceans can be uniquely determined with the current observations.

The plumes on Enceladus include salt-rich grains, for which the most likely source is a salty subsurface body of liquid.⁴¹ A global ocean which permits greater tidal flexing and heating of the ice shell is also suggested by the observed surface heat flux; however, a regional "sea" beneath the South Pole is also possible.

Because of Titan's size and the likely presence of ammonia, a subsurface ocean is plausible⁴² and expected to be a long-lived feature.

Important Questions

Some important questions concerning the location and characteristics of subsurface bodies of liquid water include the following:

- What are the depths below the surface, thickness and conductivities of the subsurface oceans of the Galilean satellites? The depth of the ocean beneath the surface is important because it controls the rate of heat loss from the ocean, and the probability of material exchange with the surface. The thickness indicates the likely ocean lifetime, and for Ganymede and Callisto constrains the ocean temperature.
- Which satellites elsewhere in the solar system possess long-lived subsurface bodies of liquid water? Titan and Enceladus are obvious candidates, but other mid-sized icy satellites, including those of Uranus and Neptune, could in theory have retained internal oceans to the present day.⁴³ Triton in particular, with its geologically young surface and current geysering, is another interesting candidate.
- For all satellites, what is the lifetime of potential oceans? Ocean lifetime is a key to habitability. If Enceladus is only intermittently active, for instance, as suggested by several lines of evidence, and thus only intermittently supports liquid water, it is less attractive as a potential habitat.⁴⁴

Future Directions for Investigations and Measurements

Important investigations and techniques for exploring subsurface liquid water include further characterization of the Galilean satellite oceans with satellite orbiters that can measure the induction response at both Jupiter's spin frequency and the satellite's orbital frequency. With two frequencies, both the ocean depth and conductivity (which constrains composition) can be solved for independently.⁴⁵ For Saturn's satellites, the negligible tilt of Saturn's magnetic field precludes induction studies by flybys, but studies may be possible from satellite orbit by exploiting the satellite's orbital eccentricity. A flyby detection of an ocean would be possible at Triton or the uranian satellites. Measurement of tidal flexing, for example at Europa, can provide strong constraints on the thickness of the overlying ice shell and the presence of an ocean. Geodetic studies of the rotation states of these bodies might provide additional constraints on ocean characteristics. Other important investigations and measurements for probing

satellite interiors should include use of subsurface sounding from orbit (e.g., using radar) to investigate the presence of near-surface water and perhaps the ice-ocean interface on Europa. In the far term in situ measurements from the surface would provide additional information on the surface composition and environment, and subsurface structure (via seismology or magnetometry). Improved compositional measurements of gas and dust ejected from the Enceladus plume (and potential Europa plumes) would provide valuable insights into the presence of liquid water at the plume source.

What are the Sources, Sinks and Evolution of Organic Material?

Life as we know it is made of organic material (i.e., complex carbon-based molecules). Organic molecules can be abiotically produced in the laboratory and it is well known that the solar system and the interstellar medium are rich in non-biological organics. The satellites have much to teach us about the formation and evolution of complex organics in planetary environments, with implications for the origin and evolution of terrestrial life.

Perhaps the clearest example of organic synthesis in our solar system is on Titan, where Cassini and Huygens have provided abundant new information.⁴⁶ Methane and nitrogen in the atmosphere are decomposed by particle and solar radiation, starting a chemical reaction cycle that produces a range of gaseous organic molecules, with molecular weights up to and exceeding 5000, and a haze of solid organics and liquid condensates.

Once on the surface the organics accumulate and apparently are responsible for the huge dunes seen in Titan's equatorial regions. The atmospheric organics probably accumulate in the lakes seen in the polar regions.

Cassini has revealed that the plume of Enceladus hosts a rich organic chemistry, including methane and a rich suite of hydrocarbons.⁴⁷ The source of the organics is not clear. Possibilities include thermal decay of organics brought in with the accreting material, Fischer-Tropsch type synthesis in a subsurface environment, rock-water reactions that can produce hydrogen, and finally, if most speculatively, methanogenic microorganisms.

Europa may have organics on its surface but this has not been conclusively demonstrated, and the radiation environment makes the survival of organics uncertain over a few million years.⁴⁸ If organics are found on the surface of Europa the next step would be to determine if these organics may have derived from the underlying ocean and if so, whether they might be biological in origin.

Important Questions

Some important questions about the sources, sinks and evolution of organic material include the following:

- What is the nature of the atmospheric processes on Titan that convert the small organic gas-phase molecules observed in the upper atmosphere (such as benzene) into large macromolecules and ultimately into solid haze particles?
- What is the fate of organics on the surface of Titan and their interaction with the seasonally varying lakes of liquid hydrocarbons?
- Are organics present on the surface of Europa, and if so, what is their provenance?
- What is the source of the organic material in the plume of Enceladus?

Future Directions for Investigations and Measurements

Observations of the surface of Europa should include the capability to determine the presence of organics, for instance by reflectance spectroscopy or low-altitude mass spectroscopy of possible out-

gassing and sputter products. Observations should also provide correlation of any surface organics with surface features related to the ocean and provide site selection for a future landed mission. Ultimately, however, a lander will probably be required to fully characterize organics on the surface of Europa. Studies of the organic processes on Titan in the atmosphere and on the surface will be best done with in situ platforms. The diversity of surface features on Titan related to organic solids and liquids suggests long range mobility is important. Measurements of the concentration of hydrogen and organics in the lower atmosphere and in surface reservoirs would allow for more quantitative determination of energy sources. Further studies of the high elevation haze region would help provide a more complete picture of the formation of organic macromolecules. Finally, detailed investigations of the organic chemistry of the plume of Enceladus, with improved mass range and resolution compared to Cassini, are needed to determine the source of this material. Similar measurements would be important for any plumes that might be found on Europa.

What Energy Sources are Available to Sustain Life?

On Earth, life derives the energy for primary productivity from two sources; sunlight and chemical redox couples (i.e., pairs of ions or molecules that can pass electrons back and forth). However for sunlight to be an effective energy source, habitable conditions are required on the surface of a planet, with atmospheric shielding of solar ultraviolet and particle radiation. In the solar system, only Earth and Titan meet these requirements. Elsewhere in the solar system, the habitable zones, if they exist, are below the surface, cut off from sunlight. In these subsurface habitats, chemical redox couples are the most likely source of energy.

On Earth we have discovered three microbial ecosystems which survive without sunlight on redox couples that are produced geologically. Two of these ecosystems are based on hydrogen released by the reaction of water with basaltic rocks and the reaction of this hydrogen with carbon dioxide.⁴⁹ Such an energy source could be operative in the ocean on Europa or in a liquid water system on Enceladus. The third system on Earth is based on oxidants produced by the dissociation of water due to natural radioactivity,⁵⁰ which produces oxidants and hydrogen. The oxidants produced generate sulfate which is then used by sulfur reducing bacteria with the hydrogen. This provides an analog for energy sources suggested for Europa and Enceladus in which oxidants are produced on the surface by ionizing radiation and are carried to the water reservoirs below the surface.⁵¹

On Titan the availability of chemical energy is obvious. The atmospheric cycle of organic production results in the formation of organics such as acetylene and ethane, with less hydrogen per carbon than methane. These compounds, as well as the solid organic material, will react with atmospheric hydrogen to release energy at levels that correspond to the needs of typical Earth microorganisms.

On Europa and Enceladus there are clearly geothermal energy sources. But the availability of a biologically usable chemical energy source (methanogen or oxidant based) remains speculative though possible.

Important Questions

Some important questions about the available energy sources for sustaining life include the following:

- What is the nature of any biologically relevant energy sources on Europa?
- What are the energy sources that drive the plume on Enceladus? These may lead to understanding the possibilities for biologically relevant energy sources.
- On Titan, how is chemical energy delivered to the surface?

Future Directions for Investigations and Measurements

Important directions for future investigations relating to energy sources for life include 1) measurement of the oxidant content and increase understanding of its formation mechanisms on the surface ice of Europa and Enceladus, 2) through remote sensing, improve understanding of geological processes that might deliver surface oxidants to subsurface liquid water, and, 3) for Titan, improve measurements of atmospheric and surface chemistry to increase understanding of the biological availability of chemical energy.

Is There Evidence for Life on the Satellites?

The search for evidence of life is an emerging science priority for the moons of the outer solar system. Organic material produced biologically is distinguishable from abiotic sources. Studies of the plume of Enceladus and any organics on the surface of Europa (or in potential Europa plumes) may provide evidence of biological complexity even if the organisms themselves are no longer present or viable. Titan has a liquid on its surface—methane, not water—and there are speculations that it may be a suitable medium for organic life as well.⁵²

The detection of organic material in the icy plume of Enceladus indicates the possibility of conditions suitable for biological processes, present or past. On Titan organic molecules are clearly present and interacting with liquids (certainly liquid hydrocarbons and possibly ammonia water mixtures) but these interactions are not necessarily of biological origin.

Important Questions

Some important questions relevant to evidence for life on the satellites includes the following:

- Does (or did) life exist below the surface of Europa or Enceladus?
- Is hydrocarbon-based life possible on Titan?

Future Directions for Investigations and Measurements

A key future investigation of the possibility of life on the outer planet satellites is to analyze organics from the interior of Europa. This requires either a lander in the far term or the discovery of active Enceladus-style venting which would allow analysis from orbit with a mission started in the next decade. A detailed characterization of the organics in the plume of Enceladus is important to search for signatures of biological origin, such as molecules with a preferred chirality or unusual patterns of molecular weights. A major investigation should be to characterize the organics on Titan's surface, particularly in liquids, to reveal any potentially biological processes occurring there.

INTERCONNECTIONS

Connections with Other Parts of the Solar System

The satellites of the outer planets embody processes that operate throughout the solar system. Io's hyperactive silicate volcanism provides living examples of volcanic processes that have been important now or in the past on all the terrestrial planets and our own Moon. Eruptions seen in recent

years are comparable to the largest terrestrial eruptions witnessed in human history. Io's high heat flow provides an analog to the terrestrial planets shortly after their formation, and its atmospheric mass loss illuminates volatile loss mechanisms throughout the solar system. Ganymede's surprising magnetic field may help us to understand the dynamos in terrestrial planets, and the poorly differentiated interiors of Callisto and Titan constrain timescales for assembly of the solar system. An understanding of Titan's methane greenhouse may illuminate anthropogenic greenhouse warming on Earth, or Venus's greenhouse, and Titan's organic chemistry illuminates terrestrial prebiotic chemical processes. Triton provides a valuable analog for large evolved bodies in the Kuiper belt such as Pluto and Eris.

In turn, studies of other bodies in the solar system help us to understand the giant planet satellites. The composition and internal structure of the giant planets constrains the raw materials and formation environments of the satellites, while the populations and compositions of primitive bodies illuminate the current and past impact environments of the satellites.

There is much overlap between planetary satellite science goals and NASA solar and space physics goals,⁵³ because many giant planet satellites are embedded in their planetary magnetospheres and interact strongly with those magnetospheres, producing a rich variety of phenomena of great interest to both fields.

Connections with Extrasolar Planets

The first detections of extrasolar planetary satellites may not be far off (Kepler may detect satellite-induced planetary wobble via transit timings, for instance). When they are found, our understanding of our own giant planet satellite systems will be essential for interpretation of the extrasolar satellite data, both for the direct understanding of those worlds and their use as constraints on the evolution of their primary planets. Extrasolar satellite systems will provide more habitable environments than their primaries in many cases, and our understanding of those environments will depend heavily on our understanding of satellites in our own solar system.

SUPPORTING RESEARCH AND RELATED ACTIVITIES

In recent years, NASA's research and analysis (R&A) activities for the outer solar system has been increased through the establishment of the Cassini Data Analysis Program (CDAP), the Outer Planets Research Program (OPRP), and the Planetary Mission Data Analysis Program (PMDAP). All of these programs have enabled understanding of outer solar system bodies to grow, and new researchers to be trained. They are essential to harvesting the maximum possible science return from missions, whether past (Voyager, Galileo) present (New Horizons, Cassini) or future (Juno, Europa Jupiter System Mission).

INSTRUMENTATION AND INFRASTRUCTURE

Satellite science will benefit from continued development of a wide range of instrument technologies designed to improve resolution and sensitivity while reducing mass and power, and to exploit new measurement techniques. Specific instrumentation requirements for the next generation of missions to the satellites of the outer planets include:

- In the immediate future, continued support for Europa orbiter instrument development. Europa instruments face unique challenges: they must survive not only unprecedented radiation doses, but also pre-launch microbial reduction needed to meet planetary protection requirements. Instrumentation for future missions will also benefit from Europa instrument development, e.g., radiation-

hardened technology for Io and Ganymede missions and the ability to survive microbial reduction processes for Enceladus.

- Instrument development for future Titan missions, particularly remote-sensing instruments capable of mapping the surface from orbit and in situ instruments needed for detailed chemical, physical, and astrobiological exploration of the atmosphere, surface and lakes, which must operate under cryogenic conditions.⁵⁴

Technology Development

Aerocapture should be considered as an option for delivering more mass to Titan in the future Titan flagship mission studies, and is likely to be mission-enabling for any future Uranus and Neptune orbiters (Chapters 7, 11, and Appendix D) mission. Further risk reduction will be required before high value and highly visible missions will be allowed to utilize aerocapture techniques.

Plutonium power sources are of course essential for most outer planet satellite exploration, and completion of development and testing of the new Advanced Stirling Radioisotope Power Generators (ASRGs), is necessary to make most efficient future use of limited plutonium supplies. However maintenance of the Multi-Mission Radioisotope Thermoelectric Generator (MMRTG) technology is also required if an MMRTG is to be used for a Titan hot-air balloon.

Hot-air balloons at Titan will be of great utility for understanding the atmospheric processes and chemistry. There is currently a European effort to advance this technology.⁵⁵ Titan aircraft provide a potential alternative to balloons if plutonium supplies are insufficient to fuel an MMRTG but sufficient for an ASRG.⁵⁶

The identification of trajectories that enable planetary missions or significantly reduce their cost is an essential and highly cost-effective element in the community's tool kit.⁵⁷ The history of planetary exploration is replete with examples, and the Enceladus orbiter mission concept discussed in this report is an example of a mission enabled by advanced trajectory analysis. A sustained investment in the development of new trajectories and techniques for both chemical propulsion and low thrust propulsion mission designs would provide a rich set of options for future missions.

A radiation effects risk reduction plan is in place and would be implemented as part of the Phase A activities for an Europa Jupiter System Mission (EJSM). Future missions to Io and Ganymede will benefit from this work and it will have to be sustained to assure that the technology base is adequate to meet the harsh radiation environment that EJSM and future missions will encounter.

Other Infrastructure

The base for thermal protection system (TPS) technology used for atmospheric entry is fragile, and is important for satellite science applications including aerocapture at Titan from heliocentric orbit, and Neptune aerocapture. The technology base that supports the thermal protection systems for re-entry vehicles was developed in the 1950s and 1960s with small advances thereafter. The near loss of the TPS technology base endangered the development of Mars Science Laboratory which required the use of Phenolic Impregnated Carbon Ablator (PICA). Although, PICA is an old technology, its use for MSL was enabled by the significant investment of the Orion TPS project that was required to resurrect a technology base that had atrophied. One very important lesson learned in this process was that several years of intense and expensive effort can be required to implement even modest TPS improvements.⁵⁸

ADVANCING STUDIES OF THE SATELLITES OF THE GIANT PLANETS: 2013-2022

The committee considered a wide range of potential mission destinations and architectures, guided by community input via white papers, with particular emphasis on the recommendations of the Outer Planet Assessment Group (OPAG).⁵⁹ The committee evaluated their cost-effectiveness in addressing the goals and objectives discussed earlier. The feasibility of several missions studied was influenced by the availability of gravity assists from Jupiter or Saturn, and the necessary planetary alignments should be considered when developing long-term strategies for solar system exploration (Figure 8.10).

The challenges of the physical scale of the outer solar system and resulting long flight times, and the relative immaturity of our understanding of outer planet satellites, are best met with the economies of mission scale: large missions are the most cost-effective. Cassini has spectacularly demonstrated the value of large, well-instrumented missions, for instance in its multi-instrument discovery and detailed characterization of activity on Enceladus. There remains a role for smaller missions, however, and mission studies conducted for the committee demonstrated that scientifically exciting and worthwhile missions can be conducted for less than the cost of the flagship missions.

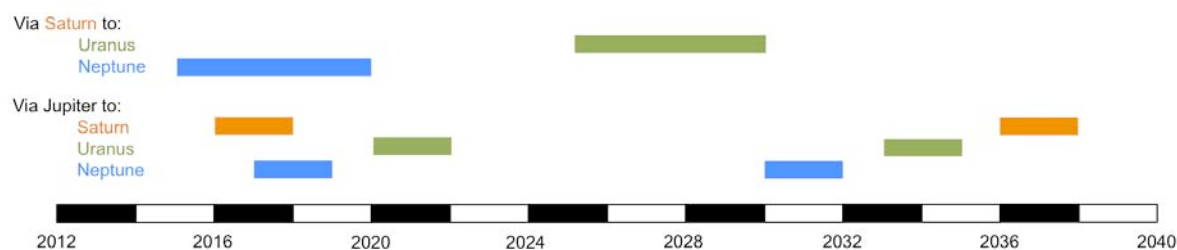

FIGURE 8.10 Approximate launch windows for gravity assist trajectories to the outer planets and their moons. Note the paucity of opportunities between 2020 and 2030, the likely range of launch dates for missions that have new starts in the coming decade. Arrival dates are much more dependent on the details of mission design, and are thus not shown here.



FIGURE 8.11 After a comprehensive tour of the Jupiter system, the Jupiter Europa Orbiter (foreground) is proposed to investigate Europa's ice shell and ocean from Europa orbit, while the ESA Jupiter Ganymede Orbiter (background) performs similar investigations at Ganymede. SOURCE: NASA/ESA.

Previously Recommended Missions

Cassini Solstice Mission

The Cassini spacecraft has been in Saturn orbit since 2004 and continues to deliver a steady stream of remarkable discoveries. Recent satellite science highlights have included direct observations of changing lake levels on Titan and high-resolution observations of the Enceladus plumes and their source regions refining our understanding of plume composition and source conditions. The extension of the mission through northern hemisphere summer solstice in 2017 will provide major opportunities for satellite science.⁶⁰ Seasonal change is key to understanding the dynamics of Titan's atmosphere and interactions with the surface, and the mission extension will more than double our seasonal timebase, including the critical period when the northern hemisphere lakes and polar vortex respond to major increases in insolation as spring advances. Twelve additional Enceladus flybys will map its gravity field, search for temporal and spatial changes in plume activity and composition, and provide unprecedented detail on the south polar thermal emission and heat flow. In addition, flybys of Rhea and Dione will probe their interiors and search for endogenic activity.

Jupiter Europa Orbiter

Europa, with its probable vast subsurface ocean sandwiched between a potentially active silicate interior and a highly dynamic surface ice shell, offers one of the most promising extraterrestrial habitable environments, and a plausible model for habitable environments beyond our solar system. The larger Jupiter system in which Europa resides hosts an astonishing diversity of phenomena, illuminating fundamental planetary processes. While Voyager and Galileo have taught us much about Europa and the Jupiter system, the relatively primitive instrumentation of those missions, and the low data volumes returned, have left many questions unanswered, and it is likely that major discoveries remain to be made.

A Jupiter Europa Explorer mission was endorsed by the NRC's first planetary decadal survey as its number one recommended flagship mission to be flown in the decade 2003-2013.⁶¹ That report states, in words that remain true today, that: *The first step in understanding the potential for icy satellites as abodes for life is a Europa mission with the goal of confirming the presence of an interior ocean, characterizing the satellite's ice shell, and understanding its geological history. Europa is important for addressing the issue of how far organic chemistry goes toward life in extreme environments and the question of how tidal heating can affect the evolution of worlds. Europa is key to understanding the origin and evolution of water-rich environments in icy satellites.* A Europa orbiter mission was subsequently given very high priority by the 2006 Solar System Exploration Roadmap,⁶² the 2007 NASA Science Plan,⁶³ and is the highest priority large mission recommended by OPAG.⁶⁴

The Europa Jupiter System Mission (EJSM), now under advanced study by NASA,⁶⁵ takes the goals of the Jupiter Europa Explorer mission and adds Jupiter system science for an even broader science return. The proposed mission will be a partnership with the European Space Agency (ESA) and will have two components, to be launched separately: a Jupiter Europa Orbiter (JEO) which will be built and flown by NASA, and a Jupiter Ganymede Orbiter (JGO), which will be built and flown by ESA, and will accomplish numerous Callisto flybys before going into orbit around Ganymede. Both spacecraft will be in the jovian system at the same time, allowing for unprecedented synergistic observations. Even if ESA's JGO does not fly, the NASA JEO mission will enable huge leaps in our understanding of icy satellites, giant planets, and planetary systems, addressing a large fraction of the science goals outlined in this chapter.

The overarching goals of this mission are as follows, in decreasing priority order:

1. Characterize the extent of the ocean and its relation to the deeper interior.
2. Characterize the ice shell and any subsurface water, including their heterogeneity, and the nature of surface-ice- ocean exchange.
3. Determine global surface compositions and chemistry, especially as related to habitability.
4. Understand the formation of surface features, including sites of recent or current activity, and identify and characterize candidate sites for future in situ exploration.
5. Understand Europa's space environment and interaction with the magnetosphere.
6. Jupiter system science (Jupiter's atmosphere, magnetosphere, other satellites, and rings).

Launched in 2020, JEO would enter the Jupiter system in 2026, using Io for a gravity assist prior to Jupiter orbit insertion. This strategy increases the delivered mass to Europa by significantly decreasing the required Jupiter orbit insertion propellant in trade for a modest increase in the radiation shielding of the flight system. The JEO mission design features a 30-month jovian system tour, which includes four Io flybys, nine Callisto flybys (including one near-polar), six Ganymede flybys, and six Europa flybys along with ~2.5 years observing Io's volcanic activity, and Jupiter's atmosphere, magnetosphere, and rings.



FIGURE 8.12 Galileo color image of Europa, showing the disruption of the ubiquitous ridged plains by chaos, associated with dark hydrated material which may be derived from the subsurface ocean. Small-scale patches of brighter color are artifacts resulting from noise in the original data. The image is about 150 km across. SOURCE: NASA/JPL.

After the jovian tour phase, JEO would enter orbit around Europa and spend the first month in a 200 kilometer circular orbit before descending to a 100 kilometer circular orbit for another 8 months. The mission would end with impact onto Europa.

Flagship-class missions historically have a greatly enhanced science return compared to smaller missions—the whole is greater than the sum of the parts—so the higher cost of a flagship mission compared to a New Frontiers-class mission is well justified. Europa remains the highest priority for satellite exploration, and a Europa mission deserves sufficient resources to realize its phenomenal scientific potential. Therefore, a Europa mission should take precedence over smaller missions to outer solar system targets during the next decade. If ESA’s Jupiter Ganymede Orbiter also flies, then the science return will be even higher.

The intense jovian radiation environment remains the largest challenge for the JEO spacecraft and its instruments, though thanks to extensive study of the issue in the past decade, the risks and mitigation strategies are now well understood. This work has included characterization of the radiation hardness of key electronic components (including development of an “approved parts and materials list” for use by instrument developers), improved modeling of expected radiation fluxes, and detailed consideration of

shielding strategies. NASA should continue to work closely with instrument developers to understand and mitigate the impact of radiation on JEO instruments, prior to final payload selection.

Io Observer

Io provides the ideal target to study tidal dissipation and the resulting variety of volcanic and tectonic processes in action, with fundamental implications for the thermal co-evolution of the Io-Europa-Ganymede system as well as for habitable zones around other stars. As such, an Io mission is of high scientific priority,⁶⁶ as highlighted in the first planetary decadal survey⁶⁷ and 2007 New Frontiers recommendations.⁶⁸ An Io mission was studied in detail at the committee's request. The study (Appendix G) and subsequent CATE analysis (Appendix C) found this mission to a plausible candidate for the New Frontiers program.

The science goals of the Io Observer mission include the following:

- Study Io's active volcanic processes;
- Determine melt fraction of Io's mantle;
- Constrain tidal heating mechanisms;
- Study tectonic processes;
- Investigate interrelated volcanic, atmospheric, plasma-torus, and magnetospheric mass-and energy-exchange processes;
- Constrain the state of Io's core via improved constraints on whether Io generates a magnetic field; and
- Investigate endogenic and exogenic processes controlling surface composition

Two baseline options were studied, one used ASRGs and the other was solar powered. Each was a Jupiter orbiter carrying a narrow-angle camera, ion-neutral mass spectrometer, thermal mapper, and magnetometers and performing 10 Io flybys. A floor mission with reduced payload and six flybys was also studied, as was an enhanced payload including a plasma instrument. A high-inclination orbit (~45°) provides polar coverage to better constrain the interior distribution of tidal heating and significantly reduces accumulated radiation: estimated total radiation dose is half that estimated for the Juno mission. No new technology is required. All science objectives are addressed by the floor mission and accomplished to much greater extent by the baseline and enhanced missions. This mission provides complementary science to that planned by JEO (which is limited by JEO's low-inclination orbit, less Io-dedicated instrumentation, and small number—three—of Io science flybys, plus one non-science Io flyby).

The Io Observer mission could also, with the addition of suitable particles and fields instrumentation (perhaps funded separately), address some of the science goals of the Io Electrodynamics mission considered by the 2003 solar and space physics decadal survey.⁶⁹

New Missions

Flagship Missions

Further exploration of Titan is a very high priority for satellite science. White papers from the community provide strong support for Titan science⁷⁰ and OPAG endorsed a Titan flagship mission as its second-highest priority flagship mission as part of an outer planets program.⁷¹

Titan Saturn System Mission

Many Titan mission concept studies have been conducted over the last decade including the most recent Outer Planet Flagship Mission study.⁷² In that study, completed in 2009, NASA and ESA worked jointly to define a flagship-class mission that would achieve the highest priority science. The resulting concept is called the Titan Saturn System Mission (TSSM) and has three overarching science goals:

1. Explore and understand processes common to Earth on another body, including the nature of Titan's climate and weather and their time evolution, its geological processes, the origin of its unique atmosphere, and analogies between its methane cycle and Earth's water cycle.
2. Examine Titan's organic inventory; a path to pre-biological molecules. This includes understanding the nature of atmospheric, surface, and subsurface organic chemistry, and the extent to which that chemistry might mimic the steps that led to life on Earth.
3. Explore Enceladus and Saturn's magnetosphere—clues to Titan's origin and evolution. This includes investigation of Enceladus's plume for clues to the origin of Titan ices and a comparison of its organic content with that of Titan, and understanding Enceladus's tidal heating and its implications for the Saturn system.

The intent of Goal 1 is to investigate the physical processes, many of which are similar to those on Earth, that shape Titan's atmosphere, surface and evolution.

Goal 2 investigates Titan's rich organic chemistry. An extensive study is particularly important because it will elucidate the chemical pathways that occur in two environments, which may resemble those of early Earth. Measurements of the composition of the thermosphere will determine whether amino acids are made in the upper atmosphere. The chemical pathways that lead to these prebiotic molecules will be investigated to determine whether this formation mechanism is typical, and whether prebiotic molecules are common in irradiated methane and nitrogen rich atmospheres, perhaps typical of early Earth. Measurements of the surface will investigate the progress of Titan's organic chemistry over longer time periods.

Goal 3 investigates Enceladus, whose plumes provide a unique view of the composition and chemistry of the interior, which is likely representative of the same types of icy materials that formed Titan. This goal could possibly be addressed by a separate Enceladus mission as described below, but Enceladus science remains high priority for a Titan mission, if Enceladus is not targeted separately. The TSSM mission design includes Enceladus flybys prior to Titan orbit insertion, but some Titan mission architectures, such as aerocapture directly from heliocentric orbit, might preclude Enceladus science unless the spacecraft subsequently left Titan orbit for Enceladus, and these trades require further study as mission concepts are developed further.

The study of such a complex system requires both orbital and in situ elements, and the TSSM concept included three components—an orbiter, a balloon, and a lander.

The TSSM science was rated on an equivalent level with the Europa Jupiter System Mission by both NASA and ESA science review panels. The science was rated as excellent and science implementation rated as low risk, though the need for continued technology development for TSSM was noted. Based on technical readiness, a joint NASA-ESA recommendation in 2009 prioritized, EJSM first, followed closely by TSSM. The multi-element mission architecture is appropriate because it enables complementary in situ and remote-sensing observations. The TSSM study demonstrated the effectiveness of such an approach for accomplishing the diverse science objectives that are high-priorities for understanding Titan. However the details of such an implementation are likely to evolve as studies continue.

Technology needs for Titan, including surface sampling, balloons, and aerocapture, which may enable delivery of additional mass to Titan, were prominent in OPAG's technology recommendations.⁷³ Technology-development priorities for this mission are those needed to address the mission design risks

identified by the Outer Planet Flagship review panel.⁷⁴ Specific components highlighted as requiring development include the following the following:

- In situ elements enabling extensive areal coverage. The Montgolfière balloon system proposed for TSSM is a promising approach⁵⁰, but an airplane, which could use an ASRG rather than an MMRTG⁵², may be more appropriate if there is a limited supply of Pu-238;
- Mature in situ analytical chemistry systems that have high resolution and sensitivity; and
- Sampling systems that can operate reliably in cryogenic environments. (See Chapter 11 for additional details.)

Furthermore, mission studies have shown that any future mission to Saturn will require the use of suitable radioisotope power sources, thus placing a high priority on the completion of the ASRGs and the restart of the plutonium production program within the U.S. Department of Energy.

The committee commissioned a detailed study of a Titan Lake Probe (Appendix D and G) considering the mission and instrument capabilities needed to examine the lake-atmosphere interaction as set forth in the TSSM study report⁶¹. In addition, the Titan Lake Probe study evaluated the feasibility and value of additional capability to directly sample the subsurface and lake bottom. The integrated floater/submersible concepts in this study were designed to make measurements at various lake depths and even sample the sediment on the bottom of the lake. The findings indicated that such a system that includes floater and submersible components and enhanced instrumentation would result in significantly increased science, but also significantly increased mass relative to the simpler TSSM lake lander concept. Based on results of this study, further studies are needed to refine lander concepts as part of a flagship mission. Stand-alone lake lander concepts, independent of TSSM, were also studied (Appendix D and G) but were judged to be less cost-effective than a lake lander integrated with TSSM.



FIGURE 8.13 The three elements of the 2009 TSSM mission architecture: A Titan orbiter, a lake lander, and a hot-air balloon. SOURCE: ESA/NASA;

Enceladus Orbiter

Enceladus, with its remarkable active cryovolcanic activity, including plumes that deliver samples from a potentially habitable subsurface environment, is a compelling target for future exploration,⁷⁵ and OPAG recommended study of mid-sized Enceladus missions for the coming decade.⁷⁶ Mission studies commissioned by the committee indicated that a focused Enceladus orbiter mission is both scientifically compelling and at lower cost than Europa or Titan flagship missions (Appendix C). Enceladus orbiters have been the subject of several previous mission studies, most recently in 2007.⁷⁷

The most important science goals for an Enceladus mission, in decreasing priority order, are the following:

1. What is the nature of Enceladus's cryovolcanic activity, including conditions at the plume source, the nature of the energy source, delivery mechanisms to the surface, and mass loss rates?
2. What is the internal structure and chemistry (particularly organic chemistry) of Enceladus, including the presence and chemistry of a global or regional subsurface ocean?
3. What is the nature of Enceladus's geological history, including tectonism, viscous modification of the surface, and other resurfacing mechanisms?
4. How does Enceladus interact with the rest of the saturnian system?
5. What is the nature of the surfaces and interiors of Rhea, Dione, and Tethys?
6. Surface characterization for future landing sites.

The committee commissioned a broad study of possible mission architectures including flybys, simple and flagship-class orbiters, landers, and plume sample return missions, and concluded that a simple orbiter would provide compelling science (Appendix G). A follow-up detailed study (Appendix G) found that the above science goals could be addressed well using a simple orbiter with a payload consisting of a medium-angle camera, thermal mapper, magnetometer, mass spectrometer, dust analyzer, and radio science. Sophisticated use of leveraged flybys of Saturn's mid-sized moons before Enceladus orbit insertion reduced delta-V requirements, and thus mass and cost, compared to previous studies.⁷⁸ The mission requires plutonium for power, in the form of ASRGs, but requires little other new technology development. However, planetary protection is an issue for Enceladus because of the possibility of contamination of the probable liquid water subsurface environment, and mission costs could increase somewhat if it proves necessary to sterilize the spacecraft to meet planetary protection guidelines.

Ice Giant Orbiters

The exploration of the uranian satellites could potentially be accomplished by the Uranus Orbiter and Probe mission discussed in Chapter 7. The proposed satellite tour (Appendix G), which includes two targeted flybys of each of the five major satellites, would help to fill a major gap in understanding of planetary satellites, because the sides opposite to those seen by Voyager 2 would be illuminated, flybys would be closer than those of Voyager (for instance potentially enabling magnetic sounding of satellite interiors), and because of instrumentation improvements relative to Voyager. Neptune orbiter and flyby missions (Appendices D and G) could potentially address many Triton science goals.

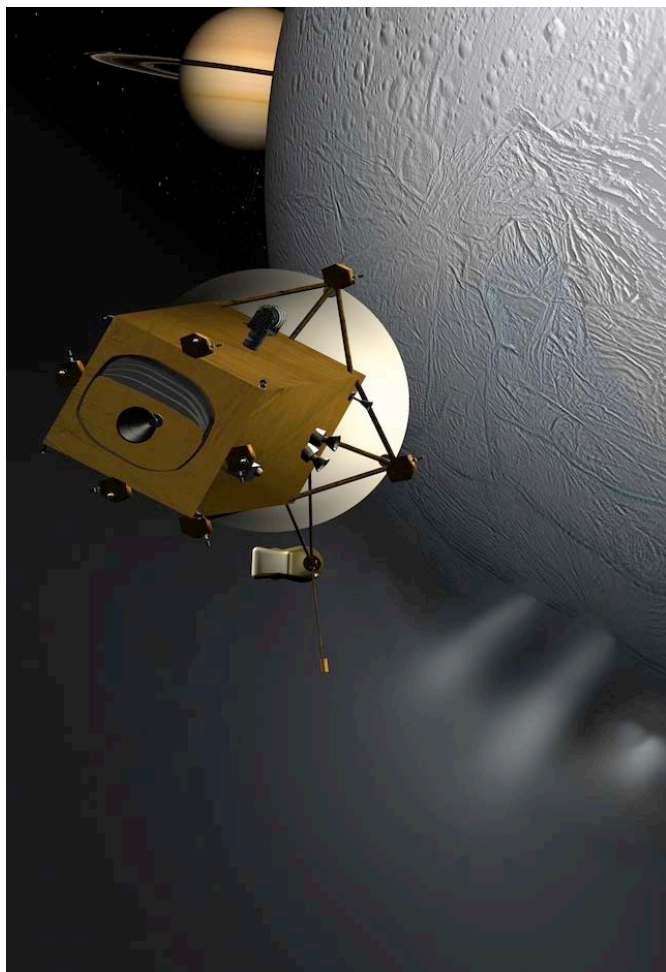

FIGURE 8.14 The Enceladus Orbiter mission concept, studied and recommended by the Satellites panel, flying above Enceladus's active south pole. SOURCE: NASA/JPL/Caltech.

New Frontiers Missions

Rationale for Prioritization of Missions and Mission Studies

The decision to give higher priority to the Jupiter Europa Orbiter flagship mission than to the Titan Saturn System flagship mission was made as follows. The likely scientific return from the Europa and Titan missions would both be very high and comparable in value, but the Jupiter Europa Orbiter mission was judged to have greater technical readiness. The technical readiness of the Europa mission results from a decade of detailed study dating back to the original Europa Orbiter concept, for which an AO was issued in 1999. The biggest technical issue for the Europa mission, the high radiation dose, remains challenging but has been mitigated by this extensive preparatory work. The Titan Saturn System Mission concept is considerably less mature, with more potential for the emergence of unanticipated problems. Also, the Titan mission is much more dependent for achievement of its science goals on integration with externally supplied mission components. While the Jupiter Europa Orbiter is intended as an element of a multi-spacecraft mission, operating in tandem with the ESA-supplied Jupiter Ganymede Orbiter, the missions are launched and flown separately, so integration issues are relatively minor. Also,

PREPUBLICATION COPY—SUBJECT TO FURTHER EDITORIAL CORRECTION

8-35

the majority of the Jupiter Europa Orbiter science goals are achieved independently of the Jupiter Ganymede Orbiter. In contrast, many key science objectives of the Titan mission rely on the balloon and lander elements, which are in an early stage of development. The use of three spacecraft elements at Titan (orbiter, lander, and balloon) also increases the complexity of spacecraft integration and mission operations, and thus the associated risk.

For these and other reasons, the independent evaluation of the 2008 Flagship mission studies rated the Europa mission as having lower mission implementation and cost risk than the Titan flagship mission. Estimated costs to NASA as estimated by the Decadal Survey (Appendix C) were lower for the Jupiter Europa Orbiter (\$4.7 billion in FY2015 dollars) than for the Titan Saturn System Mission (at least \$5.7 billion, after subtraction of the estimated \$1 billion cost of the ESA-supplied balloon and lake lander from the \$6.7 billion estimate for an all-NASA mission, and addition of any potential costs associated with dividing the mission between NASA and ESA). Finally, the outer planets community, as represented by the Outer Planets Assessment Group (OPAG), ranked the Europa mission as their highest priority flagship mission, followed by Titan. JEO is also given higher priority than the Enceladus Orbiter for two prime reasons. JEO's flagship-class payload will return a greater breadth and volume of science data than the more focused payload of the Enceladus Orbiter (see the discussion of mission size above). Also the severe limitations of the Galileo data set, due to Galileo's low data rate and the older technology of its instrument payload, mean that our knowledge of Europa and the Jupiter system is now poorer than our knowledge of Enceladus and the Saturn system, giving a particularly high potential for new discoveries by JEO at Europa and throughout the Jupiter system.

Among the smaller missions studied by the panel, the Enceladus Orbiter was given highest priority because of the breadth of science questions that it can address (with the potential for major contributions to understanding the chemistry, active geology and geophysics, and astrobiological potential of Enceladus), coupled with its relatively simple implementation, requiring little new technology. The Io Observer was chosen as a New Frontiers candidate because of its compelling science and because it was the only outer planet satellite mission studied for which cost estimates placed it plausibly within the New Frontiers cost cap. Of the other satellite missions studied (Appendix D) the stand-alone Titan Lake Lander was rated lower priority because of its relatively narrow science focus and relatively challenging technology requirements. The Ganymede Orbiter was rated as lower priority for a NASA mission because of the probability that the planned European Jupiter Ganymede Orbiter will achieve most of the same science goals.

Other stand-alone Titan mission concepts that could achieve a subset of the goals of the TSSM mission are also possible. However, implementation of such stand-alone missions is challenging, as evidenced by the fact that only one additional mission that could replace an element of TSSM was proposed in any of the community white papers submitted to the Decadal Survey: a stand-alone Titan airplane.⁷⁹ This concept is intriguing, and is noted above as a possible alternative to a balloon as an element of a flagship mission. However, high data rates are required to obtain full benefit from the remote sensing that would be a key measurement goal of an aircraft or balloon. High data rates are difficult to achieve without use of a relay spacecraft, making aircraft or balloons less attractive as stand-alone mission candidates than the lake lander chosen for detailed study. One additional stand-alone mission, the Titan Geophysical Network was proposed in a white paper (Lorenz et al. 2009), but was not chosen for detailed study because the science goals, which go beyond those of TSSM, were judged to be of lower priority, and the required low-power radioisotope power supplies would require significant additional development. A stand-alone Titan orbiter, without the in situ elements might also be considered, but was not chosen for study because it was not proposed by community white papers, and because of the advantages of an integrated orbiter and in situ elements both for delivery to Saturn and for data relay.

Summary

To achieve the primary goals of the scientific study of the satellites of the giant planet systems as outlined in this chapter, the following actions are needed.

- *Flagship missions*—The planned continuation of the Cassini mission through 2017 is the most cost-effective and highest priority way to advance our understanding of planetary satellites in the near-term. The highest priority satellite-focused missions to be considered for new starts in the coming decade are, in priority order: (1) Jupiter Europa Orbiter component of EJSM as described in the 2008 science definition team report and refined subsequently (including several Io science flybys); (2) Titan flagship mission, with both Titan-orbiting and in situ components; and (3) Enceladus Orbiter. JEO is synergistic with ESA's JGO. However, JEO's priority is independent of the fate of ESA's JGO. The Uranus Orbiter and Probe mission discussed in Chapter 7 would return very valuable satellite science, but is not prioritized here relative to the satellite-focused missions discussed in this chapter.
- *New Frontiers missions*—An Io Observer, making multiple Io flybys from Jupiter orbit is the high priority medium-size mission. The Ganymede Orbiter concept studied at the committee's request (Appendices D and G) was judged to be of lower priority for a stand-alone NASA mission.
- *Technology development*—After the development of the technology necessary to enable JEO, the next highest priority goes to addressing the technical readiness of the orbital and in situ elements of TSSM. Priority areas include the balloon system, low mass/power instruments, and cryogenic surface sampling systems.
- *International cooperation*—The synergy between the JEO, JGO, and JAXA's proposed Jupiter Magnetospheric Orbiter is great. Continued collaboration between NASA, ESA, and JAXA to enable the implementation of all three components of EJSM is encouraged. Also encouraged is the NASA-ESA cooperation needed to develop the technologies necessary to implement a Titan flagship mission.

REFERENCES

1. Estrada et al. 2009. Formation of Jupiter and conditions for accretion of the Galilean satellites. Pp. 27-58 in *Europa* (R. Pappalardo, W. McKinnon, and K. Khurana, eds.). University of Arizona Press, Tucson.
2. R. Jaumann, R.L. Kirk, R.D. Lorenz, R.M.C. Lopes, E. Stofan, E.P. Turtle, H.U. Keller, C.A. Wood, C. Sotin, L.A. Soderblom, and M.G. Tomasko. 2009. Geology and surface processes on Titan. Pp. 75-140 in *Titan from Cassini-Huygens* (R. Brown, J-P. LeBreton, and J.H. Waite, eds.). Springer, Heidelberg.
3. L. Iess, N.J. Rappaport, R.A. Jacobson, P. Racioppa, D.J. Stevenson, P. Tortora, J.W. Armstrong, and S.W. Asmar. 2009. Gravity field, shape, and moment of inertia of Titan. *Science* 327:1367.
4. J.R. Spencer, A.C. Barr, L.W. Esposito, P. Helfenstein, A.P. Ingersoll, R. Jaumann, C.P. McKay, F. Nimmo, C.C. Porco, and J.H. Waite. 2009. Enceladus: An active cryovolcanic satellite. Pp. 683-724 in *Saturn from Cassini-Huygens* (M. Dougherty, L. Esposito, and T. Krimigis, eds.). Springer, Heidelberg.
5. J. Lunine, M. Choukroun, D. Stevenson, and G. Tobie. 2009. The origin and evolution of Titan. Pp. 75-140 in *Titan from Cassini-Huygens* (R. Brown, J-P. LeBreton, and J.H. Waite, eds.). Springer, Heidelberg.
6. S. Atreya, R. Lorenz, and J.H. Waite 2009. Volatile origin and cycles: Nitrogen and methane. Pp. 177-199 in *Titan from Cassini-Huygens* (R. Brown, J-P. LeBreton, and J.H. Waite, eds.). Springer, Heidelberg.

PREPUBLICATION COPY—SUBJECT TO FURTHER EDITORIAL CORRECTION

7. O. Mousis, J.I. Lunine, M. Pasek, D. Cordier, J.H. Waite, K.E. Mandt, W.S. Lewis, and M.-J. Nguyen. 2009. A primordial origin for the atmospheric methane of Saturn's moon Titan. *Icarus* 204:749-751.
8. W.M. Grundy, L.A. Young, J.R. Spencer, R.E. Johnson, E.F. Young, and M.W. Buie. 2006. Distributions of H₂O and CO₂ ices on Ariel, Umbriel, Titania, and Oberon from IRTF/SpeX observations. *Icarus* 184:543-555.
9. G. Schubert, H. Hussmann, V. Lainey, D.L. Matson, W.B. McKinnon, F. Sohl, C. Sotin, G. Tobie, D. Turrini, and T. Van Hoolst. 2010. Evolution of icy satellites. *Space Science Reviews* 153:447-484.
10. G. Schubert, H. Hussmann, V. Lainey, D.L. Matson, W.B. McKinnon, F. Sohl, C. Sotin, G. Tobie, D. Turrini, and T. Van Hoolst. 2010. Evolution of icy satellites. *Space Science Reviews* 153:447-484.
11. J. Meyer and J. Wisdom. 2008. Tidal evolution of Mimas, Enceladus, and Dione. *Icarus* 193:213-223.
12. V. Lainey, J.-E. Arlot, O. Karatekin, and T. van Hoolst. 2009. Strong tidal dissipation in Io and Jupiter from astrometric observations. *Nature* 459:957-959.
13. L. Iess, N.J. Rappaport, R.A. Jacobson, P. Racioppa, D.J. Stevenson, P. Tortora, J.W. Armstrong, and S.W. Asmar. 2009. Gravity field, shape, and moment of inertia of Titan. *Science* 327:1367.
14. L. Prockter and G.W. Patterson. 2009. Morphology and evolution of Europa's ridges and bands. Pp. 237-258 in *Europa* (R. Pappalardo, W. McKinnon, and K. Khurana, eds.). University of Arizona Press, Tucson.
15. P.M. Schenk and M.H. Bulmer. 1998. Origin of mountains on Io by thrust faulting and large-scale mass movements. *Science* 279:1514.
16. G. Collins and F. Nimmo. 2009. Chaotic terrain on Europa. Pp. 237-258 in *Europa* (R. Pappalardo, W. McKinnon, and K. Khurana, eds.). University of Arizona Press, Tucson.
17. R. Jaumann, R.L. Kirk, R.D. Lorenz, R.M.C. Lopes, E. Stofan, E.P. Turtle, H.U. Keller, C.A. Wood, C. Sotin, L.A. Soderblom, and M.G. Tomasko. 2009. Geology and surface processes on Titan. Pp. 75-140 in *Titan from Cassini-Huygens* (R. Brown, J-P. LeBreton, and J.H. Waite, eds.). Springer, Heidelberg.
18. L. Iess, N.J. Rappaport, R.A. Jacobson, P. Racioppa, D.J. Stevenson, P. Tortora, J.W. Armstrong, and S.W. Asmar. 2009. Gravity field, shape, and moment of inertia of Titan. *Science* 327:1367.
19. R. Jaumann, R.N. Clark, F. Nimmo, A.R. Hendrix, B.J. Buratti, T. Denk, J.M. Moore, P.M. Schenk, S.J. Ostro, and R. Srama. 2009. Icy satellites: Geological evolution and surface processes. Pp. 636-682 in *Saturn from Cassini-Huygens* (M. Dougherty, L. Esposito, and T. Krimigis, eds.). Springer, Heidelberg.
20. E.B. Bierhaus, C.R. Chapman, and W.J. Merline. 2005. Secondary craters on Europa and implications for cratered surfaces. *Nature* 437:1125-1127.
21. L. Dones, C.R. Chapman, W.B. McKinnon, H.J. Melosh, M.R. Kirchoff, G. Neukum, and K.J. Zahnle. 2009. Icy satellites of Saturn: Impact cratering and age determination. Pp. 613-635 in *Saturn from Cassini-Huygens* (M. Dougherty, L. Esposito, and T. Krimigis, eds.). Springer, Heidelberg.
22. S.D. Wall, R.M. Lopes, E.R. Stofan, C.A. Wood, J.L. Radebaugh, S.M. Hörst, B.W. Stiles, R.M. Nelson, L.W. Kamp, M.A. Janssen, and R.D. Lorenz. 2009. Cassini RADAR images at Hotei Arcus and western Xanadu, Titan: Evidence for geologically recent cryovolcanic activity. *Geophys. Res. Lett.* 36:L04203.
23. F. Nimmo, J.R. Spencer, R.T. Pappalardo, and M.E. Mullen. 2007. Shear heating as the origin of the plumes and heat flux on Enceladus. *Nature* 447:289-291.
24. E.B. Bierhaus, C.R. Chapman, and W.J. Merline. 2005. Secondary craters on Europa and implications for cratered surfaces. *Nature* 437:1125-1127.

25. J.R. Spencer, S.A. Stern, A.F. Cheng, H.A. Weaver, D.C. Reuter, K. Retherford, A. Lunsford, J.M. Moore, O. Abramov, R.M.C. Lopes, J.E. Perry, et al. 2007. Io volcanism seen by New Horizons: A major eruption of the Tvashtar volcano. *Science* 318:240.
26. M.A. McGrath, E. Lellouch, D.F. Strobel, P.D. Feldman, and R.E. Johnson. 2004. Satellite atmospheres. Pp. 457-483 in *Jupiter: Planet, Satellites, and Magnetosphere* (F. Bagenal, T. Dowling, and W. McKinnon, eds.). Cambridge University Press, Cambridge.
27. M.A. McGrath, E. Lellouch, D.F. Strobel, P.D. Feldman, and R.E. Johnson. 2004. Satellite atmospheres. Pp. 457-483 in *Jupiter: Planet, Satellites, and Magnetosphere* (F. Bagenal, T. Dowling, and W. McKinnon, eds.). Cambridge University Press, Cambridge.
28. W. Grundy and L. Young. 2004. Near-infrared spectral monitoring of Triton with IRTF/SpeX I: Establishing a baseline for rotational variability. *Icarus* 172:455-465.
29. L.M. Feaga, M. McGrath, and P.D. Feldman. 2009. Io's dayside SO₂ atmosphere. *Icarus* 201:570-584.
30. D.F. Strobel, S.K. Atreya, B. Bézard, F. Ferri, F.M. Flasar, M. Fulchignoni, E. Lellouch, and I. Müller-Wodarg. 2009. Atmospheric structure and composition. Pp. 234-258 in *Titan from Cassini-Huygens* (R. Brown, J-P. LeBreton, and J.H. Waite, eds.). Springer, Heidelberg.
31. O. Grasset, et al. (Eds) 2010. Satellites of the Outer Solar System: Exchange Processes Involving the Interiors. *Space Science Reviews*, Volume 153, Issue 1-4, pp. 5-9..
32. C. Paranicas, J.F. Cooper, H.B. Garrett, R.E. Johnson, and S.J. Sturmer. 2009. Europa's radiation environment and its effects on the surface. Pp. 529-544 in *Europa* (R. Pappalardo, W. McKinnon, and K. Khurana, eds.). University of Arizona Press, Tucson.
33. C.F. Chyba. 2000. Energy for microbial life on Europa. *Nature* 403:381-382.
34. R.E. Johnson, O.J. Tucker, M. Michael, E.C. Sittler, H.T. Smith, D.T. Young, and J.H. Waite. 2009. Mass loss processes in Titan's upper atmosphere. Pp. 373-391 in *Titan from Cassini-Huygens* (R. Brown, J-P. LeBreton, and J.H. Waite, eds.). Springer, Heidelberg.
35. P.A. Delamere, A. Steffl, F. Bagenal. 2004. Modeling temporal variability of plasma conditions in the Io torus during the Cassini era. *J. Geophys. Res. (Space Physics)* 109:10216.
36. J.D. Richardson, J.W. Belcher, A. Szabo, and R. McNutt. 1995. The plasma environment of Neptune. Pp. 279-340 in *Neptune and Triton* (D. Cruikshank, ed.). University of Arizona Press, Tucson.
37. M.G. Kivelson et al. 2004. Magnetospheric interactions with satellites. Pp. 513-536 in *Jupiter: Planet, Satellites, and Magnetosphere* (F. Bagenal, T. Dowling, and W. McKinnon, eds.). Cambridge University Press, Cambridge.
38. C. Paranicas, J.F. Cooper, H.B. Garrett, R.E. Johnson, and S.J. Sturmer. 2009. Europa's radiation environment and its effects on the surface. Pp. 529-544 in *Europa* (R. Pappalardo, W. McKinnon, and K. Khurana, eds.). University of Arizona Press, Tucson.
39. T.I. Gombosi et al. 2009. Saturn's magnetospheric configuration. Pp. 203-255 in *Saturn from Cassini-Huygens* (M. Dougherty, L. Esposito, and T. Krimigis, eds.). Springer, Heidelberg.
40. K.K. Khurana, M.G. Kivelson, K.P. Hand, and C.T. Russell. 2009. Electromagnetic induction from Europa's ocean and the deep interior. Pp. 571-586 in *Europa* (R. Pappalardo, W. McKinnon, and K. Khurana, eds.). University of Arizona Press, Tucson.
41. F. Postberg et al. 2009. Sodium salts in E-ring ice grains from an ocean below the surface of Enceladus. *Nature* 459:1098-1101.
42. Sotin, C. et al. 2009. Titan's interior structure. In *Titan from Cassini-Huygens*, R. Brown, J-P. LeBreton, J.H. Waite, eds., Springer, Heidelberg, pp. 61-73.
43. H. Hussmann et al. 2006. Subsurface oceans and deep interiors of medium-sized outer planet satellites and large trans-neptunian objects. *Icarus* 185:258-273.
44. J.R. Spencer, A.C. Barr, L.W. Esposito, P. Helfenstein, A.P. Ingersoll, R. Jaumann, C.P. McKay, F. Nimmo, C.C. Porco, and J.H. Waite. 2009. Enceladus: An active cryovolcanic satellite. Pp. 683-724 in *Saturn from Cassini-Huygens* (M. Dougherty, L. Esposito, and T. Krimigis, eds.). Springer, Heidelberg.

45. K.K. Khurana, M.G. Kivelson, K.P. Hand, and C.T. Russell. 2009. Electromagnetic induction from Europa's ocean and the deep interior. Pp. 571-586 in *Europa* (R. Pappalardo, W. McKinnon, and K. Khurana, eds.). University of Arizona Press, Tucson.
46. F Raulin, C. McKay, J. Lunine, and T. Owen. 2009. Titan's astrobiology. Pp. 215-233 in *Titan from Cassini-Huygens* (R. Brown, J-P. LeBreton, and J.H. Waite, eds.). Springer, Heidelberg.
47. J.H. Waite et al. 2009. Liquid water on Enceladus from observations of ammonia and 40Ar in the plume. *Nature* 460:487-490.
48. K.P. Hand et al. 2009. Astrobiology and the potential for life on Europa. Pp. 589-629 in *Europa* (R. Pappalardo, W. McKinnon, and K. Khurana, eds.). University of Arizona Press, Tucson.
49. F.H. Chapelle et al. 2002. A hydrogen-based subsurface microbial community dominated by methanogens. *Nature* 415:312-315.
50. L.-H. Lin et al. 2006. Long-term sustainability of a high-energy, low-diversity crustal biome. *Science* 314:479-482.
51. C.F. Chyba. 2000. Energy for microbial life on Europa. *Nature* 403:381-382.
52. C.P. McKay and H.D. Smith. 2005. Possibilities for methanogenic life in liquid methane on the surface of Titan. *Icarus* 178:274-276.
53. National Research Council. 2003. *The Sun to the Earth—and Beyond: A Decadal Research Strategy in Solar and Space Physics*. The National Academies Press, Washington, D.C.
54. P.M. Beauchamp, W. McKinnon, T. Magner, S. Asmar, H. Waite, S. Lichten, E. Venkatapathy, T. Balint, A. Coustenis, J.L. Hall, M. Munk, et al. 2009. *Technologies for Outer Planet Missions: A Companion to the Outer Planet Assessment Group (OPAG) Strategic Exploration White Paper*. White paper submitted to the Planetary Science Decadal Survey, National Research Council, September 12.
- D. Schultze-Makuch, F. Raulin, C. Phillips, K. Hand, S. Neuer, and B. Dalton. 2009. *Astrobiology Research Priorities for the Outer Solar System*. White paper submitted to the Planetary Science Decadal Survey, National Research Council. September 15.
55. A. Coustenis et al. 2009. *Future in situ balloon exploration of Titan's atmosphere and surface*. White paper submitted to the Planetary Science Decadal Survey, National Research Council.
- J. Nott et al. 2009. *Advanced Titan Balloon Design Concepts*. White paper submitted to the Planetary Science Decadal Survey, National Research Council.
56. L. Lemke. 2009. *Heavier Than Air Vehicles For Titan Exploration*. White paper submitted to the Planetary Science Decadal Survey, National Research Council.
57. N. Strange et al. 2009. *Astrodynamics research and analysis funding*. White paper submitted to the Planetary Science Decadal Survey, National Research Council.
58. E. Venkatapathy et al 2009. *Thermal Protection System Technologies for Enabling Future Outer Planet Missions*. White paper submitted to the Planetary Science Decadal Survey, National Research Council.
59. W. McKinnon et al. 2009. *Exploration Strategy for the Outer Planets 2013-2022: Goals and Priorities*. White paper submitted to the Planetary Science Decadal Survey, National Research Council.
60. L. Spilker et al. 2009. *Cassini-Huygens Solstice Mission*. White paper submitted to the Planetary Science Decadal Survey, National Research Council.
61. National Research Council. 2003. *New Frontiers in the Solar System: An Integrated Exploration Strategy*. The National Academies Press, Washington, D.C.
62. NASA solar system Exploration Roadmap 2006. 2006 Solar System Exploration Roadmap for NASA's Science Mission Directorate. http://solarsystem.nasa.gov/multimedia/downloads/SSE_RoadMap_2006_Report_FC-A_med.pdf.
63. NASA Science Plan 2007. NASA Science Mission Directorate Science Plan 2007. http://science.nasa.gov/media/medialibrary/2010/03/31/Science_Plan_07.pdf.
64. W. McKinnon et al. 2009. *Exploration Strategy for the Outer Planets 2013-2022: Goals and Priorities*. White paper submitted to the Planetary Science Decadal Survey, National Research Council.

65. K. Clark et al. 2009. Jupiter Europa Orbiter Mission Study 2008: Final Report.
66. D. Williams et al. 2009. Future Io exploration for 2013-2022 and beyond, Part 1: Justification and science objectives.
67. National Research Council. 2003. *New Frontiers in the Solar System: An Integrated Exploration Strategy*. The National Academies Press, Washington, D.C.
68. National Research Council. 2008. *Opening New Frontiers in Space: Choices for the Next New Frontiers Announcement of Opportunity*. The National Academies Press, Washington, D.C.
69. National Research Council. 2003. *The Sun to the Earth—and Beyond: A Decadal Research Strategy in Solar and Space Physics*. The National Academies Press, Washington, D.C.
70. A. Coustenis et al. 2009. Future in situ balloon exploration of Titan's atmosphere and surface. White paper submitted to the Planetary Science Decadal Survey, National Research Council.
- J. Lunine et al. 2009. *The Science of Titan and Its Future Exploration*. White paper submitted to the Planetary Science Decadal Survey, National Research Council.
- J.H. Waite et al. 2009. Titan Lake Probe. White paper submitted to the Planetary Science Decadal Survey, National Research Council.
- M. Allen et al. 2009. Astrobiological Research Priorities for Titan. White paper submitted to the Planetary Science Decadal Survey, National Research Council.
71. W. McKinnon et al. 2009. Exploration Strategy for the Outer Planets 2013-2022: Goals and Priorities. White paper submitted to the Planetary Science Decadal Survey, National Research Council.
72. K. Reh et al. 2009. Titan Saturn System Mission Study Final Report. JPL D-48148.
73. P.M. Beauchamp et al. 2009. Technologies for Outer Planet Missions: A Companion to the Outer Planet Assessment Group (OPAG) Strategic Exploration White Paper. White paper submitted to the Planetary Science Decadal Survey, National Research Council.
74. C. Niebur. 2009. Outer Planet Satellites Review Panel Report. Available at <http://www.lpi.usra.edu/opag/march09/presentations/02Niebur.pdf>.
75. P. Tsou et al. 2009. A Case for an Enceladus Flyby Sample Return, LIFE. White paper submitted to the Planetary Science Decadal Survey, National Research Council.
- J. Lunine et al. 2009. *The Science of Titan and Its Future Exploration*. White paper submitted to the Planetary Science Decadal Survey, National Research Council.
- T. Hurford et al. 2009. The Case for Enceladus Science. White paper submitted to the Planetary Science Decadal Survey, National Research Council.
- T. Hurford et al. 2009. The Case for an Enceladus New Frontiers Mission. White paper submitted to the Planetary Science Decadal Survey, National Research Council.
76. W. McKinnon et al. 2009. Exploration Strategy for the Outer Planets 2013-2022: Goals and Priorities. White paper submitted to the Planetary Science Decadal Survey, National Research Council.
77. A. Razzaghi et al. 2007. Enceladus Flagship Mission Concept Study, Goddard Spaceflight Center.
78. A. Razzaghi et al. 2007. Enceladus Flagship Mission Concept Study, Goddard Spaceflight Center.
79. L. Lemke. 2009. Heavier Than Air Vehicles For Titan Exploration. White paper submitted to the Planetary Science Decadal Survey, National Research Council.

9

Recommended Flight Investigations: 2013-2022**JUDGING MISSION AND RELATED PRIORITIES**

The statement of task for this study (Appendix A) called for creation of a prioritized list of flight investigations for the decade 2013-2022. This chapter addresses that request. A prioritized list implies that the elements of the list have been judged and ordered with respect to a set of appropriate criteria. Four criteria were used. The first and most important was science return per dollar. Science return was judged with respect to the key scientific questions described in Chapter 3; costs were estimated via a procedure described below. The second was programmatic balance—striving to achieve an appropriate balance among mission targets across the solar system and an appropriate mix of small, medium, and large missions. The other two criteria were technological readiness and availability of trajectory opportunities within the 2013-2022 time period.

The recommendations in this chapter are also informed by key findings and recommendations of Chapters 4-8. These are summarized in Table 9.1.

UNDERLYING PROGRAMMATIC REQUIREMENTS

The individual flight projects for the coming decade must be considered within the context of the broader program of planetary exploration. The goal is to develop a fully integrated strategy of flight projects, technology development, and supporting research that maximizes the value of scientific knowledge gained over the decade. All of the recommendations that follow assume the following programmatic requirements:

- Continue missions currently in flight, subject to approval via the appropriate senior review process. These missions include the Cassini mission to the Saturn system, several ongoing Mars missions, the New Horizons mission to Pluto, ongoing Discovery missions, and others. Ensure a level of funding that is adequate for successful operation, analysis of data, and publication of the results of these missions, and for extended missions that afford rich new science return.
 - Continue missions currently in development. These include the GRAIL Discovery mission, the Juno New Frontiers mission, and the MSL and MAVEN missions to Mars.
 - Increase funding for fundamental research and analysis grant programs, beginning with a 5 percent increase above the total finally approved fiscal year (FY) 2011 expenditures and then growing at an additional 1.5 percent per year above inflation for the remainder of the decade (Chapter 10). This increase will enable the full scientific benefits of ongoing and future flight projects to be reaped.
 - Establish and maintain a significant and steady level of funding (6 to 8 percent of the planetary exploration budget) for development of technologies that will enable future planetary flight projects.
 - Continue to support and upgrade the technical expertise and infrastructure in implementing organizations that support solar system exploration missions.
- Continue to convey the results of planetary exploration to the general public via a robust program of education and public outreach.

TABLE 9.1 Key Findings and Recommendations from Chapters 4-8.

	Chapter 4 The Primitive Bodies	Chapter 5 The Inner Planets	Chapter 6 Mars	Chapter 7 The Giant Planets	Chapter 8 Satellites
Flagship Missions	Not proposed. Use limited resources to initiate technology program to assure that Cryogenic Comet Sample Return can be carried out in the 2020s.	Top and only priority is the Venus Climate Mission.	Initiate the Mars Sample Return campaign. First and highest priority element is Mars Astrobiology Explorer-Cacher (MAX-C)	Top and only priority for a new flagship mission is the Uranus Orbiter and Probe. Europa Jupiter System Mission should: —Maintain Jupiter system science as high priority —Designate Jupiter system science as top-ranked priority during approach and early tour phases —Incorporate Jupiter system science specific needs into jovian tour design	Continue Cassini mission. Highest priority new mission in priority order: 1. Jupiter Europa Orbiter component of EJSM. 2. Titan flagship mission. 3. Enceladus Orbiter.
New Frontiers Missions	Raise the cost cap. Goals in priority order: 1. Comet Surface Sample Return 2. Trojan Tour and Rendezvous	Regular cadence is highly desirable. Goals in priority order: 1. Venus In Situ Explorer 2. South Pole-Aitken Basin Sample Return 3. Lunar Geophysical Network	Neither Mars Geophysical Network nor Mars Polar Climate missions are recommended at this time.	Current cost cap is insufficient to permit many of the highest interest missions. Only possible current mission is Saturn Probe.	Io Observer is higher priority than Ganymede Orbiter.
Discovery Missions	Ensure an appropriate cadence of future Discovery missions.	Ensure a regular cadence of future Discovery missions.	Small spacecraft missions can make important contributions to the study of Mars.	Allow proposals for targeted and facility-class orbital space telescopes in Discovery program.	
International Cooperation		Continue support via participating scientist programs and Missions of Opportunity.	MSR could proceed as NASA-only program, but international collaboration is needed to make real progress. Trace Gas Orbiter is an appropriate start.		Encourage continued collaboration between NASA, ESA, and JAXA to enable the implementation of all three components of EJSM.

All of the recommendations below are made under the assumption that the programmatic requirements listed above are fully funded.

PREVIOUSLY RECOMMENDED MISSIONS

The 2002 decadal survey recommended a total of nine missions:¹

- The Europa Geophysical Explorer was the highest priority Flagship class mission in the report.
- Five candidate New Frontiers missions were also recommended—Kuiper Belt-Pluto Explorer, South Pole-Aitken Basin Sample Return, Jupiter Polar Orbiter with Probes, Venus In Situ Explorer, and Comet Surface Sample Return.
- Three Mars missions were recommended—Mars Science Laboratory, Mars Upper Atmospheric Orbiter, and Mars Long-Lived Lander Network.

Mars Sample Return was considered an important mission for the decade 2013-2022, and the previous decadal survey recommended that technology development for this mission begin in the decade covered by that survey. A subsequent NRC report expanded the list of potential New Frontiers missions to include Network Science, Trojan/Centaur Reconnaissance, Asteroid Rover/Sample Return, Io Observer, and Ganymede Observer.²

Of the missions in the last decadal survey, Kuiper Belt-Pluto Explorer has been implemented with the first New Frontiers mission, New Horizons, launched in 2005. The second New Frontiers mission, Juno, scheduled for launch in 2011, will accomplish most of the goals of the Jupiter Polar Orbiter with Probes mission, albeit without the probes. The Mars Science Laboratory (MSL) has been built and is scheduled for a 2011 launch; as built it is significantly more ambitious and costly than the MSL mission described in the previous decadal survey report. The MAVEN Mars Scout mission addresses the objectives of the Mars Upper Atmospheric Orbiter. Missions responsive to the science goals of the South Pole-Aitken Basin Sample Return, the Venus In Situ Explorer, and the Asteroid Rover/Sample Return are currently in competition to be selected as the third New Frontiers mission.

For this decadal survey, only missions that already had a new start (i.e., the President's budget requested funding for them, the Congress approved this request, and the President signed the budget bill) were assumed a priori to be part of NASA's plan. All other missions were evaluated on an equal basis to one another. In contrast to the last decadal survey, Mars missions were considered on an equal basis with all other planetary missions.

This decadal survey has placed considerable emphasis on cost realism. While NASA has been responsive to the priorities set out in the previous decadal survey, the planetary program has been plagued by overly optimistic assumptions about mission costs. Planetary science is not unique in this regard; optimism in the face of technical challenges is common to many costly endeavors.³ Nevertheless, the result has been that far fewer missions have flown than were recommended. Noteworthy examples include the cost growth of the Mars Science Laboratory, the periods of reduced tempo of Discovery missions, and the fact that neither of the very high priority missions to orbit Europa and return samples from Mars has yet been initiated. In order to achieve greater cost realism, this decadal survey has relied heavily on detailed mission studies and cost estimates derived using a methodology specifically designed to quantify technical, schedule, and cost risks inherent in assessing concepts with differing degrees of technical maturity (see Appendix C).

MISSION STUDY PROCESS AND TECHNICAL EVALUATION

In the course of this decadal survey, the committee commissioned technical studies of many candidate missions (Appendix G). These candidate missions were selected for study on the basis of white papers submitted by the scientific community and the recommendations of the panels. Each study was led by one or more “science advocates” from the committee’s panels (selected by the panel based upon their expertise to represent the panel’s science interests), and was conducted by the Jet Propulsion Laboratory, the Applied Physics Laboratory, Goddard Space Flight Center, or Marshall Space Flight Center. The studies were funded by NASA and delivered to the agency, which then delivered them to the decadal survey. Although NASA was aware of the contents of the studies, the agency was not involved in the direction of the studies themselves or their prioritization by the decadal survey.

A subset of the mission studies was selected by the committee for further Cost and Technical Evaluation (CATE) by The Aerospace Corporation, a contractor to the National Research Council. This selection was made on the basis of the four prioritization criteria listed above. The CATE process was designed to provide an independent assessment of the technical feasibility of the mission candidates, as well as to produce a rough estimate of their costs. The process takes into account many factors when evaluating a mission’s potential costs, including the actual costs of analogous previous missions. It therefore reflects cost impacts that may be beyond the control of project managers and principal investigators. It includes a probabilistic model of cost growth due to technical and schedule risks, and hence projects cost growth resulting from insufficient technical maturity identified as part of the technical evaluation. Following NASA policy, costs were estimated at the 70 percent confidence level. Appendix C discusses the CATE process in more detail.

The CATE process typically resulted in cost estimates that were significantly higher than the estimates produced by the study teams. The primary reason for this is that basing cost estimates on the actual costs of analogous part projects avoids the inherent optimism of other cost estimation processes. Only the independently generated cost estimates were used in evaluation of the candidate missions by the committee in formulating the final recommendations. This approach is intentionally cautious, and was designed to help avoid the unrealistic cost estimates and consequent replanning that has sometimes characterized the planetary program in the past. In the sections below, we present both a recommended plan that is based on these conservative cost estimates, and recommendations for what could be added to the plan if the estimates prove to be too conservative.

It should be stressed that the studies carried out were of specific “point designs” for the mission candidates that were identified by the committee’s panels. These point designs are a “proof of concept” that such a mission may be feasible, and provide a basis for developing a cost estimate for the purpose of the decadal survey. The actual missions as flown may differ in their detailed designs and their final costs from what was studied, but **in order to maintain a balanced and orderly program, their final costs must not be allowed to grow significantly beyond those estimated here.** This fact is one of many reasons why a cautious approach to cost estimation is appropriate. The sections below make specific recommendations for steps that should be taken if the projected costs of certain missions grow beyond expected bounds.

DEFINITION OF MISSION COST CLASSES

The committee’s statement of task divides NASA’s planetary missions into three distinct cost classes: small missions costing less than \$450 million current year dollars, medium missions costing between \$450 and \$900 million, and large missions costing more than \$900 million current year dollars. The first corresponds to the Discovery and Mars Scout programs, the second to the New Frontiers program, and the third to the so-called “Flagship” missions. It is within the committee’s purview, per the statement of task, to recommend changes to the classes, including their cost ranges.

As discussed in more detail below, the Discovery program remains vibrant and highly valuable, allowing the science community to propose a diverse range of low-cost missions with short development times and focused science objectives.

The New Frontiers program fills the middle ground between the small and relatively inexpensive Discovery missions and the much larger and more costly Flagship missions. Inspired by the success of the Discovery program, New Frontiers missions are also selected via a competitive process and led by a principal investigator (PI). In contrast to the Discovery program, New Frontiers solicitations are more strategic, restricting proposals to a small number of specific mission goals. New Frontiers missions address focused science goals that cannot be implemented within the Discovery cost cap, but do not require the resources of a Flagship mission.

Flagship missions are more expensive than the New Frontiers cost cap, and can cost up to several billion dollars. They are strategic in nature and are designed to address a wide range of important scientific objectives at high-priority targets. They often involve multi-agency and international cooperation. Because of their scientific breadth and high cost they are not PI-led, but typically carry a large and sophisticated payload of instruments, most of which are led by individual PIs. Some also carry “facility” instruments that typically are provided by the institution that builds the spacecraft. Despite their high costs, flagship missions are consistently characterized by high science return per dollar.

BALANCE AMONG MISSION COST CLASSES

The issue of finding the optimum balance among small, medium and large missions has been addressed in a recent NRC/SSB study.⁴ The report of a subsequent NRC workshop touched on balance in the context of the decadal survey process: “[The discussion] reinforced the concept of the decadal survey as a strategic package. Decadal studies need to provide the best balance of scientific priorities and prioritized missions.”⁵

The challenge is to assemble a portfolio of missions that achieves a regular tempo of solar system exploration and a level of investigation appropriate for each target object. For example, a program consisting of only Flagship missions once per decade may result in long stretches of relatively little new data being generated, leading to a stagnant community. Conversely, a portfolio of only Discovery-class missions would be incapable of addressing important scientific challenges like in-depth exploration of the outer planets.

Mission classes are differentiated not only by their costs but also by the time scale of execution, span of technology, and involvement of the scientific community. Flagship missions like Viking, Galileo, and Cassini ordinarily have a ~10-year development cycle. They require very capable launch vehicles. They involve large teams of investigators and a complex of supporting institutions. Each Flagship mission is unique in terms of its scientific objectives and frequently also in terms of the spacecraft used, so each is often a new development with little use of heritage hardware.

New Frontiers missions, while still complex and challenging, can be executed on timescales significantly less than a decade. These missions have less extensive, more focused scientific objectives than Flagship missions and typically take advantage of technological developments from recent prior missions. The institutional arrangements are less complex and the launch vehicle requirements less demanding.

Discovery missions can respond rapidly to new discoveries and changes in scientific priorities. Rapid mission development (~3 years) is feasible, providing opportunities for student participation, rapid infusion and demonstration of technology and a rapid cadence of missions pursuing scientific goals. These missions are executable using relatively small launch vehicles.

In studying any given object, there is a natural progression of mission types, from flyby to orbital investigation to in situ exploration to sample return. The missions early in this progression are generally simpler and less costly than the later ones. So, because the long-term goals of planetary science involve

thorough study of many objects, a balanced portfolio may contain a variety of mission categories, depending on the level of investigation that has been conducted previously.

The workshop report mentioned above developed criteria by which a scientific program might be assessed. Although written almost five years ago, the criteria, slightly rephrased, are still relevant:

- *Capacity to make steady progress*—Does the proposed program make reasonable progress toward the scientific goals set forth in the decadal survey? Are the cadence of missions and the planning process such that new scientific discoveries can be followed up rapidly with new missions, such as small missions in the Discovery program? Does the program smoothly match and complement programs initiated by prior decadal surveys?
- *Stability*—Can one construct an orderly sequence of missions, meeting overarching scientific goals, developing advanced technology, sizing and nurturing the research and technical community and providing for appropriate interactions with the international community? Is the program stable under the inevitable budgetary perturbations as well as the occasional mission failures?
- *Balance*—Is the program structured to contain a mix of small, medium, and large missions that together make the maximum progress toward the scientific goals envisioned by this decadal survey? Can some of the scientific objectives be reached or approached via missions of opportunity and by means of piggyback or secondary flights of experiments on other NASA missions?
- *Robustness*—Is the program robust in that it provides opportunities for the training and development of the next generation of planetary scientists? Is it robust in that it lays the technological foundation for a period longer than the present decade?

The criteria cited above are not orthogonal. “Balance” in various guises permeates the other three criteria. For example, a balanced portfolio of missions enhances overall program stability; a balanced portfolio of missions provides better assurance of a continuing stream of visible results. A balanced portfolio also helps prevent large excursions in workforce demands and cost, therefore fitting more easily into the relatively smooth year-to-year NASA budget.

Several factors can upset mission balance. Foremost among these is the lack of control and predictability of mission costs. A 30 percent overrun in the cost of a mission costing several billion dollars can distort the entire program of planetary science recommended in a given decadal survey.⁶ Or, as stated in stark language in a NRC report, *An Assessment of Balance in NASA’s Science Programs*: “The major missions in space and Earth science are being executed at costs well in excess of the costs estimated at the time when the missions were recommended in the National Research Council’s decadal surveys for their disciplines. Consequently, the orderly planning process that has served the space and Earth science communities well has been disrupted and the balance among large, medium and small missions has been difficult to maintain.”⁷ The report continues with the recommendation that NASA should undertake independent, comprehensive and systematic evaluations of the costs to complete each of its space and Earth science missions for the purpose of determining adequacy of budget and schedule.

NASA’s suite of planetary missions for the decade 2013-2022 should consist of a balanced mix of Discovery, New Frontiers, and Flagship missions, enabling both a steady stream of new discoveries and the capability to address larger challenges like sample return missions and outer planet exploration. The program recommended below was designed to achieve an appropriate balance. In order to prevent the balance among mission classes from becoming skewed, it is crucial that all missions, particularly the most costly ones, be initiated with a good understanding of their probable costs. The Cost and Technical Evaluation process used in this decadal survey was specifically designed to address this issue by taking a realistic approach to cost estimation.

The cost containment record of AO-selected missions is relatively commendable, with a few notable exceptions where the mission complexity or other factors was underestimated. The committee endorses the recommendations in a recent NRC report that call on NASA to undertake the following actions:⁸

- Ensure that there are adequate levels of project funds for risk reduction and improved cost estimation prior to final selection; and
- Develop a comprehensive, integrated strategy to control cost and schedule growth and enable more frequent science opportunities.

SMALL MISSIONS

Within the category of small missions, there are three elements of particular interest: the Discovery program, extended missions for ongoing projects, and “Missions of Opportunity”.

The Discovery Program

The Discovery program was initiated in 1992 as a way to assure frequent access to space for planetary science investigations through competed PI-led missions. The low cost and short development times of Discovery missions provide flexibility to address new scientific discoveries on a timescale significantly less than 10 years. The Discovery program is therefore outside the bounds of a decadal strategic plan, and this decadal survey makes no specific Discovery flight mission recommendations. The committee stresses, however, that **the Discovery program has made important and fundamental contributions to planetary exploration, and can continue to do so in the coming decade.** The committee gives it its strong support.

Chapters 4-8 provide examples of the rich array of science that can be addressed with future Discovery missions. At Mercury, orbital missions complementary to MESSENGER could characterize high-latitude, radar-reflective volatile deposits, map the mineralogy of the surface, characterize the atmosphere and the magnetosphere, and precisely determine the long-term rotational state. At Venus, platforms including orbiters, balloons, and probes could be used to lower atmospheric chemistry and dynamics, surface geochemistry and topography, and current and past surface and interior processes. The proximity of the Moon makes it an ideal target for future Discovery missions, using both orbital and landed platforms, building on the rich scientific findings of recent lunar missions, and the planned GRAIL and LADEE missions.

Potential Discovery missions to Mars include a 1-node geophysical pathfinder station, a polar science orbiter, a dual satellite atmospheric sounding and/or gravity mission, an atmospheric sample collection and Earth-return mission, a Phobos/Deimos surface exploration mission, and an in situ aerial mission to explore the region of the martian atmosphere not easily accessible from orbit or from the surface. We note that NASA does not intend to continue the Mars Scout program beyond the MAVEN mission, nor do we recommend that they do so. Instead, **the committee recommends that NASA continue to allow Discovery missions to be proposed to all planetary bodies, including Mars.**

Primitive body investigations are ideally suited for Discovery missions. The vast number and diversity of asteroids and comets provide opportunities to benefit from frequent launches. The proximity of some targets allows missions that can be implemented within the context of the Discovery program. Near the limit of the Discovery cost cap, it may be possible to collect and return samples from NEOs. The diversity of targets means that proven technologies may be re-flown to new targets, reducing mission risk and cost. And the population of scientifically compelling targets is not static, but is continually increasing as a consequence of discoveries in the supporting research and analysis programs.

Because there is still so much compelling science that can be addressed by Discovery missions, **the committee recommends continuation of the Discovery program at its current level, adjusted for inflation, with a cost cap per mission that is also adjusted for inflation from the current value (i.e., to about \$500 million FY2015).**

The committee does note that NASA has increased the size and number of external project reviews for Discovery missions to the point that some reviews are counterproductive and disruptive. The

committee endorses the recommendation in a recent NRC report that NASA should reassess its approach to external project reviews to ensure that:⁹

- The value added by each review outweighs the cost (in time and resources) that it places on projects;
- The number and size of reviews are appropriate given the size of the project; and
- Major reviews, such as preliminary design review and critical design review, occur only when specified success criteria are likely to be met.

Program Tempo

Discovery Announcements of Opportunity (AOs) were released in 1994, 1996, 1998, 2000, 2004, 2006 and 2010. The selected missions are listed in Table 9.2. Because Discovery missions are so important for planetary exploration, and in order for the community to plan them effectively, **the committee recommends a regular, predictable, and preferably rapid (≤ 24 month) cadence for Discovery AO releases and mission selections.** Because so many important missions can be flown within the current Discovery cost cap (adjusted for inflation), the committee views a steady tempo of Discovery AOs and selections to be more important than increasing the cost cap, as long as launch vehicle costs continue to be excluded.

The committee notes with some concern the increase in time between AO and launch in Table 9.1. Beginning with Lunar Prospector and continuing through Kepler, the time from selection to launch for Discovery missions grew steadily from 4 to 9 years. (The expected launch of GRAIL in 2011 would reverse this trend.) A hallmark of the Discovery program has been rapid and frequent mission opportunities. The committee urges NASA to assess schedule risks carefully during mission selection, and to plan program budgeting so as to maintain the original goals of the Discovery program.

Additional AO Opportunities

New knowledge regarding solar system objects has increasingly come from a combination of ground- and space-based telescopic platforms. However, there is no explicitly defined program presently in NASA planetary science where an orbital mission for observation of solar system objects can be proposed. The Discovery Program Announcement of Opportunity (AO) issued in 2010 allows missions to “target” any body in the solar system, save the Sun and Earth. But the AO is silent on the meaning of the verb “target.” Based on presentations to the committee’s panels, it appears that a highly capable planetary space telescope in Earth orbit could be accomplished as a Discovery mission. Such a mission could be particularly valuable for observations of the giant planets and their satellites. **The committee recommends that future Discovery AOs allow space-based telescopes to be proposed, and that planetary science from space-based telescopes be listed as one of the goals of the Discovery program.**

TABLE 9.2 Discovery Program Mission Selections to Date

Year of AO	Mission Selected	Launch Date	Description
n/a	Near Earth Asteroid Rendezvous/Shoemaker	17 February 1996	Asteroid orbiter and rendezvous
n/a	Mars Pathfinder	4 December 1996	Mars lander and Sojourner rover
1994	Lunar Prospector	6 January 1998	Lunar orbiter
1994	Stardust	7 February 1999	Comet particle sample return
1996	Genesis	8 August 2001	Solar wind sample return.
1996	CONTOUR	3 July 2002	Flyby of two comet nuclei (lost contact 6 weeks after launch)
1998	MESSENGER	3 August 2004	Mercury orbiter
1998	Deep Impact	12 January 2005	Comet impactor and flyby
2000	Dawn	27 September 2007	Orbit of two main-belt asteroids, Vesta & Ceres
2000	Kepler	6 March 2009	Telescope for the detection of extrasolar planets
2004	<i>No Selection</i>		
2006	GRAIL	expected 2011	Twin lunar orbiters for gravity mapping
2010	TBD	TBD	TBD

Extended Missions for Ongoing Projects

Mission extensions can be significant and highly productive, and may also enhance missions that undergo changes in scope due to unpredictable events or opportunities. The Cassini and Mars Exploration Rover extensions are examples of the former, and the “re-purposing” of missions such as Stardust (NExT) and Deep Impact (EPOXI) are examples of the latter. In some cases, particularly the re-purposing of operating spacecraft, fundamentally new science can be enabled. These mission extensions, which require their own funding arrangements, can be treated as independent, small-class missions. The committee supports NASA’s current Senior Review process for deciding the scientific merits of a proposed mission extension. **The committee recommends that early planning be done to provide adequate funding of mission extensions, particularly for Flagship missions and missions with international partners.**

Missions of Opportunity

Near the end of the last decade, NASA introduced a new acquisition vehicle called “Stand Alone Missions of Opportunity” (SALMON). This umbrella announcement allows for five different types of “Missions of Opportunity”:

1. Investigations involving participation in non-NASA space missions by providing a critical component of the mission, such as a science instrument, technology demonstrations, hardware components, microgravity research experiments, or expertise in critical areas of the mission;

2. U.S. participating investigator, where a co-investigator (non-hardware) is selected for a science or technology experiment to be built and flown by an agency other than NASA;
3. New Science Investigations that propose a new scientific use of existing NASA spacecraft;
4. Small complete missions, where science or technology investigations can be realized within the specified cost cap; and
5. Focused opportunities. That is, investigations that address a specific, NASA-identified flight opportunity. This last SALMON vehicle was recently used to acquire the U.S.-provided instruments for the Mars 2016 Trace Gas Orbiter.

In addition to their science return, Missions of Opportunity provide a chance for new entrants to join the field, for technologies to be validated, and for future PIs to gain experience. The success of this program will depend on a process that emphasizes flexibility and agility. **The committee welcomes the introduction of this highly flexible SALMON approach, and recommends that it be used wherever possible to facilitate Mission of Opportunity collaborations.**

Mars Trace Gas Orbiter

An important special case of a small mission is the proposed joint ESA/NASA Mars Trace Gas Orbiter. A Mars orbiter to study the concentrations, temporal variations, sources, and sinks of atmospheric trace gases, particularly methane, was identified in Chapter 6 to be of high scientific priority. This mission is to be conducted jointly with the European Space Agency. The mission would launch in 2016, with NASA providing the launch vehicle, ESA providing the orbiter, and a joint science payload that was recently selected. Based on its high science value and its relatively low cost to NASA, **the committee supports flight of the Mars Trace Gas Orbiter in 2016 as long as the division of responsibilities with ESA outlined above is preserved. Holding to the 2016 launch schedule is important, as failure to do so could significantly affect other missions, particularly to Mars, that are recommended below. As discussed in greater detail below, the Mars Trace Gas Orbiter is intended to be part of a long-term NASA-ESA collaboration on the exploration of Mars.**

PRIORITIZED MEDIUM AND LARGE CLASS FLIGHT MISSIONS: 2013-2022

Optimum Balance across the Solar System

As described above, NASA's program of planetary exploration should have an appropriate balance among small, medium, and large missions. It is also important for there to be an appropriate balance among the many potential targets in the solar system. Achieving this balance was one of the key factors that went into the recommendations for medium and large missions presented below. The committee notes, however, that there should be no entitlement in a publicly funded program of scientific exploration. Achieving balance must not be used as an excuse for not making difficult but necessary choices.

The issues of balance across the solar system and balance among mission sizes are related. For example, it is difficult to investigate targets in the outer solar system with small or even medium missions. On the other hand, some targets are ideally suited to small missions. The committee's recommendations below bear this fact in mind, and implicitly assume that Discovery missions will address important questions that do not require medium or large missions in order to be addressed.

It is not appropriate to achieve balance simply by allocating certain numbers or certain sizes of missions to certain classes of objects. Instead, **the appropriate balance across the solar system must be found by selecting the set of missions that best addresses the highest priorities among the**

overarching questions in Chapter 3. The recommendations below are made in accordance with this principle.

Medium Class Missions

The current New Frontiers cost cap, inflated to fiscal year 2015 dollars, is \$1.05 billion, including launch vehicle costs. **The committee recommends changing the New Frontiers cost cap to \$1.0 billion FY2015, excluding launch vehicle costs.** This change represents a modest increase in the total cost of a New Frontiers mission; the increase is fully accounted for in the program recommendations below.* As shown below, this change will allow a scientifically rich and diverse set of New Frontiers missions to be carried out. Importantly, it will also help protect the science content of the New Frontiers program against increases and volatility in launch vehicle costs. Use of technologies like low-thrust propulsion that reduce requirements on launch vehicle performance (and thereby cost) should be given credit in the proposal evaluation process.

High-Priority Medium Class Mission Candidates

The New Frontiers program to date has resulted in the selection of the New Horizons mission to Pluto and the Juno mission to Jupiter. A competition to select a third New Frontiers mission is now underway, with selection scheduled for 2011. In this report the committee addresses subsequent New Frontiers missions, beginning with the fourth, to be selected during the decade 2013-2022.

The committee's Statement of Task (Appendix A) calls for a list of specific mission objectives for New Frontiers missions. Based on their science value and projected costs, the committee has identified seven candidate New Frontiers missions for the decade 2013-2022. All of these missions address broad and important questions in planetary science, and have been judged to have high science merit when considered in light of the community-derived science priorities described in Chapter 3. All are also judged to be plausibly achievable within the recommended New Frontiers cost cap (although, for some, not within the previous cap).¹⁰ In alphabetical order, they are:

- *Comet Surface Sample Return*—The objective of this mission is to acquire and return to Earth a macroscopic sample from the surface of a comet nucleus using a sampling technique that preserves organic material in the sample. The mission would also use additional instrumentation on the spacecraft to determine the geologic and geomorphologic context of the sampled region. Because of the increasingly blurred distinction between comets and the most primitive asteroids, many important objectives of an asteroid sample return mission could also be accomplished by this mission.
- *Io Observer*—The focus of this mission is to determine the internal structure of Io and to investigate the mechanisms that contribute to the satellite's intense volcanic activity. The spacecraft would go into a highly elliptical orbit around Jupiter, making multiple flybys of Io. Specific science objectives would include characterization of surface geology and heat flow, as well as determination of the composition of erupted materials and study of their interactions with the jovian magnetosphere.
- *Lunar Geophysical Network*—This mission consists of several identical landers distributed across the lunar surface, each carrying geophysical instrumentation. The primary science objectives of this mission are to characterize the Moon's internal structure, seismic activity, global heat flow budget, bulk composition, and magnetic field. Mission duration would be several years, allowing detailed study of lunar seismic activity and internal structure.

* The committee excluded launch vehicle costs because their current uncertainty foiled any attempt to estimate their likely cost over the next decade. As a result the New Frontiers' cost is effectively raised modestly unless launch vehicle costs rise precipitously. See section "Launch Vehicle Costs" later in this chapter.

- *Lunar South Pole-Aitken Basin Sample Return*—The primary science objective of this mission is to return samples from this ancient and deeply excavated impact basin to Earth for characterization and study. In addition to returning at least 1 kilogram of samples, this mission would also document the geologic context of the landing site with high-resolution and multispectral surface imaging.
- *Saturn Probe*—This mission is intended to determine the structure of Saturn’s atmosphere as well as noble gas abundances and isotopic ratios of hydrogen, carbon, nitrogen, and oxygen. The flight system consists of a carrier-relay spacecraft and a probe to be deployed into Saturn’s atmosphere. The probe makes continuous in situ measurements of Saturn’s atmosphere as it descends ~250 km from its initial entry point and relays measurement data to the carrier spacecraft.
- *Trojan Tour and Rendezvous*—This mission is designed to examine two or more small bodies sharing the orbit of Jupiter, including one or more flybys followed by an extended rendezvous with a Trojan object. Primary science objectives for this mission include the characterization of the bulk composition, interior structure, and near-surface volatiles.
- *Venus In Situ Explorer*—The primary science objectives of this mission are to examine the physics and chemistry of Venus’ atmosphere and crust. This mission attempts to characterize variables that cannot be measured from orbit, including the detailed composition of the lower atmosphere, and the elemental and mineralogical composition of surface materials. The mission architecture consists of a lander that acquires atmospheric measurements during descent, and then carries out a brief period of remote sensing and in situ measurements on the planet’s surface.

The current competition to select the third New Frontiers mission includes the SAGE mission to Venus and the MoonRise mission to the Moon. These missions are responsive to the science objectives of the Venus In Situ Explorer and the Lunar South Pole-Aitken Basin Sample Return, respectively. We assume that the ongoing NASA evaluation of these two missions has validated their ability to be performed at a cost appropriate for New Frontiers. For the other five listed above, the Cost and Technical Evaluations performed in support of this decadal survey have shown that it may be possible to execute them within the New Frontiers cap (Appendix C).

The committee’s list of recommended New Frontiers mission candidates differs somewhat from the one in the most recent NRC report on New Frontiers.¹¹ One mission has been added (Saturn Probe), two have been removed (Asteroid Rover/Sample Return and Ganymede Observer), and one has been narrowed in focus (Network Science). These changes result from the committee’s application of the selection criteria listed at the beginning of this chapter, and reflect changes in scientific knowledge and programmatic realities since the time of that report.

Medium-Class Mission Decision Rules

In order to achieve an appropriate balance among small, medium, and large missions, NASA should select two New Frontiers missions in the decade 2013-2022. These are referred to below as New Frontiers Mission 4 and New Frontiers Mission 5.

Because preparation and evaluation of New Frontiers proposals places a substantial burden on the community and NASA, it is important to restrict each New Frontiers solicitation to a manageable number of candidate missions. **New Frontiers Mission 4 should be selected from among the following five candidates:**

- Comet Surface Sample Return,
- Lunar South Pole-Aitken Basin Sample Return,
- Saturn Probe,
- Trojan Tour and Rendezvous, and
- Venus In Situ Explorer.

PREPUBLICATION COPY—SUBJECT TO FURTHER EDITORIAL CORRECTION

These five were selected from the seven listed above based on the criteria described at the beginning of this chapter: science return per dollar, programmatic balance, technological readiness, and availability of spacecraft trajectories. All offer the potential for exceptional science return per dollar. Together they address a set of high-priority science objectives that is well balanced across the solar system, especially when considered in conjunction with the large missions recommended below. And all are technically mature and have available trajectories. No relative priorities are assigned to these five mission candidates; instead, the selection among them should be made on the basis of competitive peer review.

If either SAGE or MoonRise is selected by NASA in 2011 as the third New Frontiers mission, the corresponding mission candidate should be removed from the above list of five, reducing the number of candidates from which NASA should make the New Frontiers Mission 4 selection to four.

For the New Frontiers Mission 5 selection, the Io Observer and the Lunar Geophysical Network should be added to the list of remaining candidate missions, increasing the total number of candidates for that selection to either five or six. Again, no relative priorities are assigned to any of these mission candidates.

Large Class Missions

High-Priority Large-Class Missions

The decadal survey has identified five candidate Flagship missions for the decade 2013-2022. All of these missions have been judged to have exceptional science merit when considered in light of the community-derived science priorities described in Chapter 3. All are correspondingly costly. In alphabetical order, they are:

- *Enceladus Orbiter*—This mission would investigate that saturnian satellite's cryovolcanic activity, habitability, internal structure, chemistry, geology, and interaction with the other bodies of the Saturn system. In particular, it would provide extensive characterization of Enceladus' plumes, first discovered during the Cassini mission. Upon arrival at Saturn, the spacecraft would orbit the planet for ~3.5 years, allowing numerous flybys of several saturnian moons. It would then go into orbit around Enceladus, for a baseline 12-month mission there.
- *Jupiter Europa Orbiter*—This mission is the stand-alone U.S. component of the proposed NASA-ESA Europa Jupiter System Mission (EJSM). The latter consists of two independently launched and operated orbiters: the NASA-led Jupiter Europa Orbiter (JEO) and the ESA-led Jupiter Ganymede Orbiter. Specific science objectives for the JEO include characterization of Europa's ocean and interior, ice shell, chemistry and composition, and the geology of prospective landing sites. The preliminary mission timeline includes a 30-month jovian system tour phase, followed by a 9-month Europa orbital phase. The mission also makes observations of Jupiter itself.
- *Mars Astrobiology Explorer-Cacher*—This mission, MAX-C, is the first of three components of a joint NASA-ESA Mars Sample-Return campaign. The MAX-C rover is responsible for characterizing a landing site that has been selected for high science potential, and for collecting, documenting, and packaging samples for return to Earth. The rover is also capable of conducting high-priority in situ science on the martian surface. MAX-C is envisioned to be carried out jointly with ESA's ExoMars rover mission, with a single entry, descent and landing system delivering both rovers to the same landing site. In evaluating the science return per dollar of MAX-C, the committee considered the science return of the full Mars Sample Return campaign, and the costs of the full NASA portion of that campaign.

PREPUBLICATION COPY—SUBJECT TO FURTHER EDITORIAL CORRECTION

- *Uranus Orbiter and Probe*—This mission consists of a spacecraft that deploys a small atmospheric probe to make in situ measurements of noble gas abundances and isotopic ratios for an ice giant atmosphere. The spacecraft then enters into orbit, with the primary science objectives of making remote sensing measurements of the atmosphere, interior, magnetic field, and rings, as well as multiple flybys of the larger uranian satellites during the multi-year tour. As described in more detail below, Uranus was chosen over Neptune because of issues involving technology readiness and the availability of appropriate spacecraft trajectories.

- *Venus Climate Mission*—This mission is designed to address science objectives concerning the Venus atmosphere, including carbon dioxide greenhouse effects, dynamics and variability, surface/atmosphere exchange, and origin. The mission architecture includes a carrier spacecraft, a gondola/balloon system, a mini-probe, and two drop sondes. The mini-probe and drop sondes each have 45-minute science missions as they descend to the surface, and the gondola/balloon system carries out a 21-day science campaign as it travels at a ~55 km float altitude.

The Cost and Technical Evaluations performed for these five candidate Flagship missions have yielded estimates for the full life-cycle cost of each mission as defined above, including the cost of the launch vehicle, in fiscal year 2015 dollars. For missions with international components (EJSM and MAX-C) only the NASA costs are included. The cost estimates are as follows:

- Enceladus Orbiter, \$1.9 billion
- Jupiter Europa Orbiter, \$4.7 billion
- Mars Astrobiology Explorer-Cacher, \$3.5 billion¹²
- Uranus Orbiter and Probe, \$2.7 billion¹³
- Venus Climate Mission, \$2.4 billion

These costs are substantial, but based on a long history of cost growth for complex planetary missions, the committee believes them to be realistic. Because of the high costs of Flagship missions and the associated impact on the rest of the planetary program, the decision rules and cost caps discussed below are particularly important.

Large-Class Mission Decision Rules

The committee devoted considerable attention to the relative priorities of the various large-class mission candidates. In particular, both JEO and the Mars Sample-Return campaign (beginning with MAX-C) were found to have exceptional science merit when considered in light of the community-derived science goals described in Chapter 3. Because it was difficult to discriminate between Mars Sample Return and JEO on the basis of their anticipated science return per dollar alone, other factors came into play. Foremost among these was the need to maintain programmatic balance by assuring that no one mission takes up too large a fraction of the planetary budget at any given time.

Notably, Mars Sample Return is broken into three separate missions that can be spaced out over two or even three decades, reducing the per-year costs, and thus making it easier for programmatic balance to be maintained. In contrast, the inherent costs of getting any payload to 5 AU are substantial, and examination of JEO showed that breaking it into several smaller missions would not result in significant costs savings. The costs of JEO therefore must be incurred over a much shorter period of time. So Mars Sample Return was prioritized above JEO not primarily because of its science merit, but for pragmatic reasons associated with the required spending profiles.

The highest priority Flagship mission for the decade 2013-2022 is MAX-C, which will begin the NASA-ESA Mars Sample Return campaign. However, the cost of MAX-C must be constrained in order to maintain programmatic balance.

The Mars community, in their inputs to the decadal survey, was emphatic in their view that a sample return mission is the logical next step in Mars exploration. MAX-C will explore a new site and significantly advance our understanding of the geologic history and evolution of Mars, even before the cached samples are returned to Earth. Because of its potential to address essential questions regarding planetary habitability and life, Mars sample return has been a primary goal for Mars exploration for many years. It directly addresses all three of the crosscutting themes of Chapter 3, and it is central to the committee's Planetary Habitability theme. Mars science has reached a level of sophistication that fundamental advances in addressing the important questions in Chapter 3 will only come from analysis of returned samples.

Unfortunately, at an independently estimated cost of \$3.5 billion, MAX-C would take up a disproportionate near-term share of the overall budget for NASA's Planetary Science Division. This very high cost results in large part from two large and capable rovers—both a NASA sample-caching rover and the European Space Agency's ExoMars rover—being jointly delivered by a single entry, descent, and landing (EDL) system. The Cost and Technical Evaluation for MAX-C projected that accommodation of two such large rovers would require major redesign of the MSL EDL system with substantial associated cost growth.

The committee recommends that NASA should fly the MAX-C mission in the decade 2013-2022 only if it can be conducted for a cost to NASA of no more than approximately \$2.5 billion (FY2015 dollars). This cost should be verified via an independent cost and technical evaluation conducted after the mission architecture has been defined in adequate detail. If a cost of no more than about \$2.5 billion FY2015 cannot be verified, the mission (and the subsequent elements of Mars Sample Return) should be deferred until a subsequent decade or cancelled outright. No alternate plan for Mars exploration is recommended by the committee if this were to happen. Sample return is by far the most compelling next step in Mars exploration, and if it cannot be carried out then the other large class missions discussed below take precedence over lower-priority Mars missions.

The recommended cost cap of \$2.5 billion for MAX-C was arrived at in two ways. The first involved consideration of programmatic balance. \$2.5 billion was the highest cost that the committee felt was appropriate for MAX-C without too much of the decadal plan being devoted to Mars exploration. The second was a simple and very conservative cost estimate. The committee asked the Aerospace Corporation to estimate the costs of a worst-case scenario in which the MAX-C mission was flown as currently designed but with the ESA component removed. The estimated cost was just under \$2.5 billion. This is not an optimal design for a descoped mission, of course, and it is important to include a significant ESA component within the recommended cap. But these considerations suggest that \$2.5 billion for a descoped MAX-C mission is both appropriate and achievable.

It is likely that a significant reduction in mission scope will be needed to keep the cost of MAX-C below \$2.5 billion. A key part of this reduction in scope is likely to be reducing landed mass and volume. In particular, it is crucial to preserve, as much as possible, both the system structure and the individual elements of MSL's EDL system, realizing that any changes threaten the tested maturity of this system and may lead to expensive re-verification and/or significant decrease in capability. A significant reduction in landed mass and volume can be expected to lead to a significant reduction in the scientific capabilities of the vehicles delivered to the surface.

The committee recognizes that MAX-C is envisioned by NASA to be part of a joint NASA-ESA program of Mars exploration that also includes the 2016 Mars Trace Gas Orbiter. **In order to benefit NASA, this partnership must also involve ESA participation in other missions of the three-mission Mars Sample Return campaign.** Indeed, NASA is unlikely to be able to afford two more missions to return the samples in the following decade unless the partnership continues into that decade and ESA makes significant contributions to the costs of those missions. It is therefore crucial to both parties for the partnership to be preserved. The best way to maintain the partnership will be an equitable reduction in scope of both the NASA and ESA objectives for the MAX-C/ExoMars mission, so that both parties still benefit from it. **The guiding principle for any descoped process should be to preserve the highest priority science objectives of the total Mars program for both agencies while reducing costs**

to acceptable levels. For NASA in the coming decade, this principle means that MAX-C should acquire adequately characterized samples at a cost of no more than \$2.5 billion. And because both the NASA and ESA elements of the mission will be delivered to the same landing site, it is important to make their descoped science as complementary as possible.

As described below, the two subsequent missions in the Mars Sample Return campaign would take place after 2022. The timing is flexible; as described in Chapter 6, the MAX-C sample cache will remain scientifically viable for at least 20 years. The committee has therefore taken the unusual step of recommending a plan for the coming decade that also has significant budget implications for one or even two decades beyond. The committee does this intentionally and explicitly, with the realization that important multi-decade efforts like Mars Sample Return can only come about if such recommendations are made and followed. As noted above, the committee's recommendation is predicated on the assumption that collaboration with ESA will be maintained throughout the length of the Mars Sample Return campaign, offsetting some of NASA's costs. It is also important for the science return from the combined MAX-C and ExoMars missions to be significant even if the samples are never returned. Given the ambitious goals of MAX-C and ExoMars, this should be possible even if major descopes are necessary. The committee also stresses that significant sample-return technology investment in the decade 2013-2022 will be necessary, as discussed in more detail below.

A final point regarding MAX-C is that its success depends in part on the success of the MSL EDL system. If that system functions properly in 2012, then a \$2.5 billion MAX-C mission should go forward for launch in 2018. If it fails, however, then NASA will have to reconsider the priority and schedule for MAX-C. If the cause of failure can be determined and appropriate and affordable changes can be made in time to preserve a 2018 launch, then MAX-C can continue on schedule. However, if uncertainties remain or if the necessary changes cannot be made by 2018, then MAX-C should slip in priority and schedule relative to other large-class missions.

The second highest priority Flagship mission for the decade 2013-2022 is JEO. However, its cost as currently designed is so high that both a decrease in mission scope and an increase in NASA's planetary budget are necessary to make it affordable.

The Europa Geophysical Explorer, from which the JEO concept is derived, was the one Flagship mission recommended in the previous planetary decadal survey. The scientific case for this mission was compelling then, and it remains compelling now. There is strong evidence that Europa has an ocean of liquid water beneath its icy crust. Because of this ocean's potential suitability for life, Europa is one of the most important targets in all of planetary science. As its name implies, JEO will also do other important science in the Jupiter system, including study of other moons, and of the planet itself. Like MAX-C, JEO directly addresses all three of the crosscutting themes of Chapter 3, and is, in particular, central to Planetary Habitats. Substantial technology work has been done on JEO over the past decade, with the result that NASA is much more capable of accomplishing this mission than was the case 10 years ago.

The difficulty in achieving JEO is its cost. The projected cost of the mission as currently designed is \$4.7 billion FY2015. If JEO were to be funded at this level within the currently projected NASA planetary budget it would lead to an unacceptable programmatic imbalance, eliminating too many other important missions. Therefore, while the committee recommends JEO as the second highest priority Flagship mission, close behind MAX-C, **it should fly in the decade 2013-2022 only if changes to both the mission and the NASA planetary budget make it affordable without eliminating any other recommended missions.** These changes are likely to involve both a reduction in mission scope and a formal budgetary new start for JEO that is accompanied by an increase in the NASA planetary budget.

It is clearly crucial to keep the budget increase required to enable JEO as small as possible. Because of the maturity of the current JEO mission concept, the committee did not attempt to redesign the mission for lower cost. However, such a redesign is essential for this important mission to be viable. Possible pathways to lower cost include use of a larger launch vehicle that would reduce cost risk by shortening and simplifying the mission design, and a significant reduction in the science payload. Other possible descopes were listed in section 4.1.5 of the 2008 JEO mission study final report.¹⁴ NASA

should immediately undertake an effort to find major cost reductions for JEO, with the goal of minimizing the size of the budget increase necessary to enable the mission. As noted below, the committee also recommends that JEO switch to Advance Stirling Radioisotope Generators (ASRGs) for power production, rather than Multi-Mission Radioisotope Thermoelectric Generators (MMRTGs), reducing the amount of plutonium-238 necessary to carry out the mission.

The third highest priority Flagship mission is the Uranus Orbiter and Probe mission.

Galileo, Cassini, and Juno have performed or will perform spectacular in-depth investigations of Jupiter and Saturn. The Kepler mission and microlensing surveys have shown that many exoplanets are ice-giant sized. Exploration of the ice giants Uranus and Neptune is therefore the obvious and important next step in the exploration of the giant planets. A mission to one of these planets addresses all three of the crosscutting themes in Chapter 3. These planets are fundamentally different from Jupiter and Saturn, and a comprehensive mission to study one of them offers enormous potential for new discoveries.

The committee carefully investigated missions to both Uranus and Neptune. While both missions have high scientific merit, the conclusion was that a Uranus mission is favored for the decade 2013-2022 for practical reasons. These reasons include the lack of optimal trajectories to Neptune in that time period, long flight times incompatible with the use of Advanced Stirling Radioisotope Generators for spacecraft power, the risks associated with aerocapture at Neptune, and the high cost of delivery to Neptune. Because of its outstanding scientific potential and a projected cost that is well matched to its anticipated science return, **the Uranus Orbiter and Probe mission should be initiated in the decade 2013-2022 even if both MAX-C and JEO take place.** But like those other two missions, the Uranus Orbiter and Probe should be subjected to rigorous independent cost verification throughout its development, and descoped or canceled if costs grow significantly above the projected \$2.7 billion FY2015.

The fourth and fifth highest priority Flagship missions are, in alphabetical order, the Enceladus Orbiter and the Venus Climate Mission. The scientific cases for these missions are presented in Chapters 8 and 5, respectively. In order to maintain an appropriate balance among small, medium, and large missions, **these missions should be considered for the decade 2013-2022 only if higher-priority Flagship missions cannot be flown for unanticipated reasons, or if additional funding makes them possible, as noted below.** No relative priority is assigned to these two missions; rather, any choice between them should be made on the basis of programmatic balance. In particular, because of the broad similarity of its science goals to those of JEO, NASA should consider flying the Enceladus Orbiter in the decade 2013-2022 only if JEO is not carried out in that decade.

As stressed several times, the costs of the recommended Flagship missions must not be allowed to grow above the values quoted in this report. Central to accomplishing this is avoiding “requirements creep”—i.e., the increase in the scope of a mission that sometimes occurs early in its development. The CATE process that was used to estimate mission costs accounts for unanticipated technical problems, but it does not account for a lack of discipline that allows a mission to become too ambitious. In order to preserve programmatic balance, then, **the scope of each of the recommended Flagship missions cannot be permitted to increase significantly beyond what was assumed during the committee’s cost estimation process.**

Example Flight Programs For the Decade 2013-2022

Following the priorities and decision rules outlined above, two example programs of solar system exploration can be described for the decade 2013-2022 (Table 9.3). These example programs address the highest priority questions identified by the planetary science community, and their cost realism is based on Cost and Technical Evaluations conducted in support of the decadal survey. Both assume continued support of all ongoing flight projects, a Research and Analysis grant program with a 5 percent increase

and further growth at 1.5 percent per year above inflation, and \$100 million FY2015 annually for technology development.

The *Recommended Program* can be conducted assuming a budget increase sufficient to allow a new start for JEO. The *Cost Constrained Program* can be conducted assuming the currently projected NASA planetary budget. The recommended program captures the highest priorities of the planetary science community, but because it does not meet the test of current affordability, the cost constrained program is also put forward. Notional funding profiles for the two programs are shown in Figure 9.1. The recommended program shown assumes the full \$4.7 billion dollars projected for JEO, but the committee stresses that this cost can and should be reduced significantly via reductions in mission scope.

Figure 9.1 shows that a scientifically rich program can be carried out for the funds expected to be available in the decade 2013-2022, and that a scientifically exceptional program can be carried out with a much-needed budget augmentation. Table 9.4 shows how the recommended program is tied to the three crosscutting themes identified in Chapter 3. While the projected costs in Figure 9.1b exceed projected funding in some years and fall below it in others, the year-to-year budget tuning necessary to fit a profile precisely is best left to NASA managers.

TABLE 9.3 Two Alternative Budget Scenarios for the Decade 2013-2022

Recommended Program	Cost Constrained Program
Discovery program funded at the current level adjusted for inflation	Discovery program funded at the current level adjusted for inflation
Mars Trace Gas Orbiter conducted jointly with ESA	Mars Trace Gas Orbiter conducted jointly with ESA
New Frontiers Mission 4	New Frontiers Mission 4
New Frontiers Mission 5	New Frontiers Mission 5
MAX-C at \$2.5 billion	MAX-C at \$2.5 billion
Jupiter Europa Orbiter	Uranus Orbiter and Probe
Uranus Orbiter and Probe	

NOTE: The recommended program can be conducted assuming an increase in the NASA budget that allows a new start for the Jupiter Europa Orbiter. The cost constrained program can be conducted assuming the currently projected NASA planetary budget. The ordering of items does not imply priority.

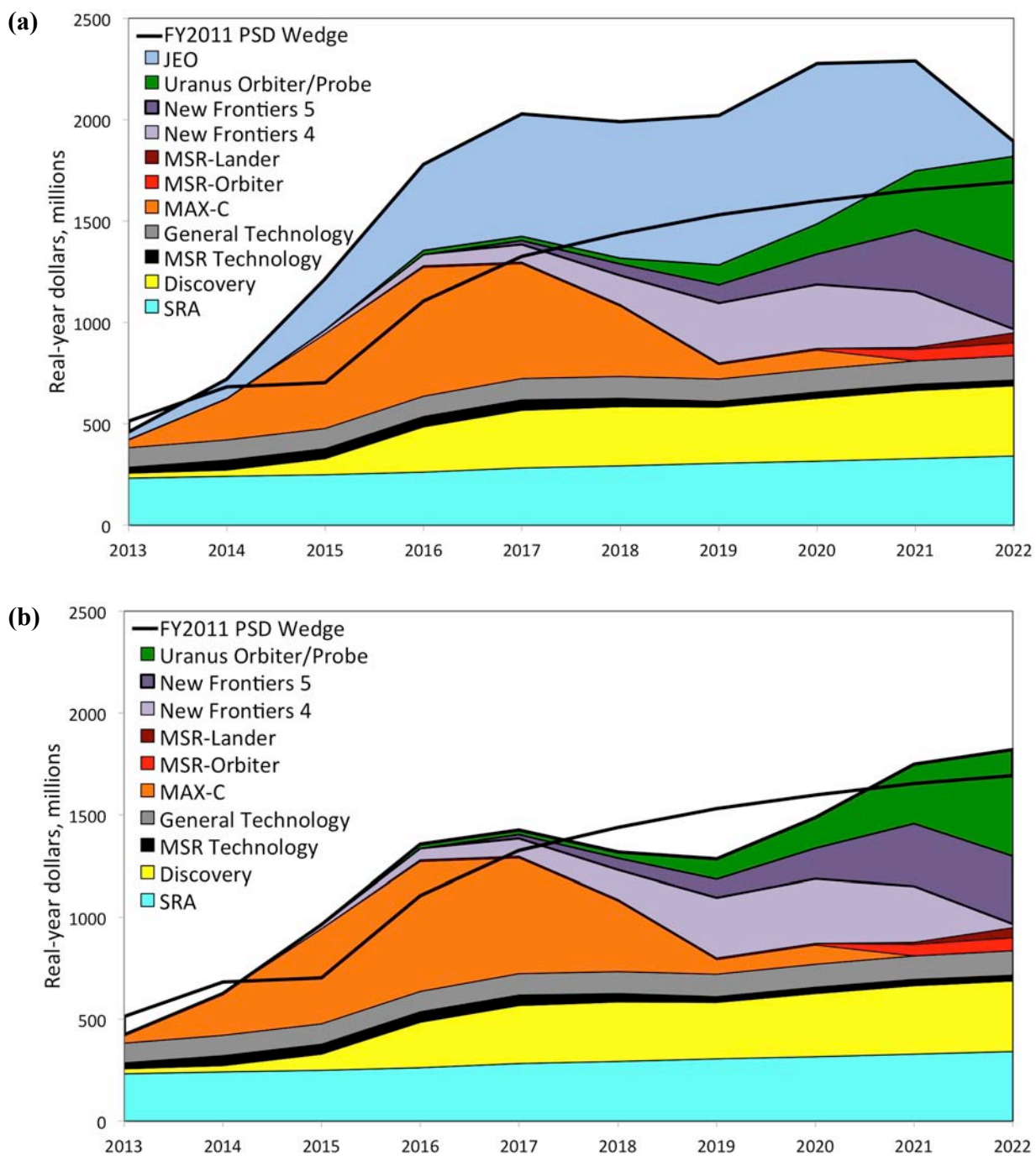

FIGURE 9.1 Notional funding profiles for the recommended (a) and cost constrained (b) programs, in real-year dollars, for fiscal years 2013-2022. The heavy black line shows the projected available funding for the NASA Planetary Science Division (PSD), accounting for all current commitments (including the Mars Trace Gas Orbiter). The available funding grows sharply in the first few years of the decade as some current programs come to an end. See Appendix E for details regarding projected available funding. The cost assumed for the Jupiter Europa Orbiter in (a) is \$4.7 billion, clearly illustrating why a reduction in the scope and cost of this mission is necessary. NOTE: Fiscal Year 2011 PSD budget wedge data provided by NASA Science Mission Directorate.

TABLE 9.4 Crosscutting Themes, Key Questions and the Missions in the Recommended Plan That Address Them (see Table 3.1 in Chapter 3 for comparison)

Crosscutting Theme	Priority Questions	Missions
Building New Worlds	1. What were the initial stages and conditions and processes of solar system formation and the nature of the interstellar matter that was incorporated?	CSSR, Trojan Tour and Rendezvous, Discovery missions
	2. How did the giant planets and their satellite systems accrete, and is there evidence that they migrated to new orbital positions?	JEO, Uranus Orbiter and Probe, Trojan Tour and Rendezvous, Io Observer, Saturn Probe, Enceladus Orbiter
	3. What governed the accretion, supply of water, chemistry, and internal differentiation of the inner planets and the evolution of their atmospheres, and what roles did bombardment by large projectiles play?	Mars Sample Return, Venus In Situ Explorer, Lunar Geophysical Network, Lunar South Pole-Aitken Basin Sample Return, Trojan Tour and Rendezvous, CSSR, Venus Climate Mission, Discovery missions
Planetary Habitats	4. What were the primordial sources of organic matter, and where does organic synthesis continue today?	Mars Sample Return, JEO, Uranus Orbiter and Probe, Trojan Tour and Rendezvous, CSSR, Enceladus Orbiter, Discovery missions
	5. Did Mars or Venus host ancient aqueous environments conducive to early life, and is there evidence that life emerged?	Mars Sample Return, Venus In Situ Explorer, Venus Climate Mission, Discovery missions
	6. Beyond Earth, are there modern habitats elsewhere in the solar system with necessary conditions, organic matter, water, energy, and nutrients to sustain life, and do organisms live there now?	Mars Sample Return, JEO, Enceladus Orbiter, Discovery missions
Workings of Solar Systems	7. How do the giant planets serve as laboratories to understand Earth, the solar system, and extrasolar planetary systems?	JEO, Uranus Orbiter and Probe, Saturn Probe
	8. What solar system bodies endanger and what mechanisms shield Earth's biosphere?	CSSR, Discovery missions
	9. Can understanding the roles of physics, chemistry, geology, and dynamics in driving planetary atmospheres and climates lead to a better understanding of climate change on Earth?	Mars Sample Return, JEO, Uranus Orbiter and Probe, Venus In Situ Explorer, Saturn Probe, Venus Climate Mission, Discovery missions
	10. How have the myriad chemical and physical processes that shaped the solar system operated, interacted, and evolved over time?	All recommended missions

As noted, the recommended and cost-constrained programs make realistic assumptions about mission costs, based on the Cost and Technical Evaluations conducted in support of this decadal survey. Plausible circumstances could improve the picture presented above. For example, if the mission costs presented above are overestimates, the budget increase required for the recommended program would be correspondingly smaller. Increased funding for planetary exploration could make even more missions possible. **If this happened, the committee’s recommended additions to the plans presented above would be, in priority order:**

1. **An increase in funding for the Discovery program,**
2. **Another New Frontiers mission, and**
3. **Either the Enceladus Orbiter or the Venus Climate Mission.**

Not all of the five candidate flagship missions discussed above can be initiated in the decade 2013-2022. The most likely outcome is that three can be initiated if NASA’s planetary budget is augmented, and two if it is not. It is therefore important to look ahead to the following decade, and to be fully prepared to consider these missions for flight then. The committee expects that all of the five candidate flagships that are not initiated in 2013-2022 will remain strong candidates at the time of the next decadal survey. Therefore, **candidate flagship missions from the list above that cannot be initiated in 2013-2022 should receive thorough technical studies and technology investments, so that they will be ready in time for consideration in the next decade.**

It is also possible that the budget picture could turn out to be less favorable than the committee has assumed. This could happen, for example, if the actual budget for solar system exploration is smaller than the projections the committee used. **If cuts to the program are necessary, the committee recommends that the first approach should be descoping or delaying Flagship missions. Changes to the New Frontiers or Discovery programs should be considered only if adjustments to Flagship missions cannot solve the problem. And high priority should be placed on preserving funding for Research and Analysis programs and for technology development.**

Deferred High-Priority Missions

The committee identified a number of additional large missions that are of high scientific value but that are not recommended for the decade 2013-2022 for a variety of reasons. In alphabetical order, these missions are:

- *Ganymede Orbiter*—This mission’s primary science objectives are the characterization of the satellite’s subsurface ocean, geology, magnetic field, and origin. These objectives will be addressed through three mission phases: a Ganymede flyby phase, a pump-down phase, and an orbital tour phase of 3, 6, or 12 months. Consideration of the Ganymede Orbiter is deferred to the decade following 2013-2022 because of its lower science return per dollar relative to the JEO mission, and because EJSM as currently envisioned would include an ESA-provided spacecraft to study Ganymede, making this mission largely redundant.
- *Mars Sample Return Lander*—This, the second component of the Mars Sample Return campaign, consists of a fetch rover to retrieve cached samples on the martian surface and an ascent vehicle to launch the samples into Mars orbit. The MAX-C caching rover will have deposited a small cache container of rock cores on the surface for pickup; the lander would then target a landing ellipse containing the cache and dispatch its fetch rover to retrieve and return the cache to the ascent vehicle. While the fetch process is underway, regolith samples would be collected via a scoop on the lander’s arm; these would also be transferred to the ascent vehicle. The ascent vehicle would then launch the samples into Mars orbit. As noted above, the committee assumes that a significant fraction of the combined cost

of this mission and the Mars Sample Return Orbiter (see below) would be borne by the European Space Agency, as part of their partnership with NASA to carry out the Mars Sample Return campaign.

- *Mars Sample Return Orbiter*—This is the third component of the Mars Sample Return campaign. It includes a Mars orbiter, an Earth-entry vehicle, and a terrestrial sample handling facility. The orbiter is designed to rendezvous with the sample launched into orbit by the Mars Sample Return Lander's ascent vehicle, then transfer this sample into the Earth-entry vehicle and return it to Earth. The MSR Lander and the MSR Orbiter are deferred to the decade following 2013-2022 because of programmatic balance and the need to execute MAX-C first. Again, the committee assumes that a significant fraction of the combined MSR Lander and Orbiter costs would be borne by ESA.
- *Mars Geophysical Network*—The primary science objectives of this mission are to characterize the internal structure, thermal state, and meteorology of Mars. The mission includes two or more identical, independent flight systems, each consisting of a cruise stage, an entry system, and a lander carrying geophysical instrumentation. Science data are relayed from each lander to an existing orbiting asset to be transmitted back to Earth. Consideration of the Mars Geophysical Network is deferred to the decade following 2013-2022 because of its lower scientific priority relative to the initiation of the Mars sample return campaign.
- *Titan Saturn System Mission*—This mission addresses key science questions regarding Saturn's satellite Titan as well as other bodies in the Saturn system. The baseline mission architecture consists of an orbiter supplied by NASA, and a lander and Montgolfière balloon supplied by ESA. These components will examine Titan, concentrating on the prebiotic chemical evolution of the satellite. In addition, in transit to Titan the mission will examine the plumes of Enceladus and take measurements of Saturn's magnetosphere. As discussed in Chapter 8, consideration of this mission is deferred to the decade following 2013-2022 primarily because of the greater technical readiness of JEO. Its high scientific priority, however, is especially noteworthy. **Because the Titan Saturn System Mission is a particularly strong candidate for the future, continued thorough study of it is recommended.**
- *Neptune System Orbiter and Probe*—If unforeseen circumstances were to make it impossible to begin the Uranus Orbiter and Probe mission on the schedule recommended above, Neptune could become an attractive alternate target for most ice giant system science. The committee's mission studies indicate, however, that significant hurdles remain in the area of aerocapture or other mission-enabling technologies for a Neptune Orbiter and Probe to be feasible at a reasonable cost.

While consideration of the missions listed above is deferred to the following decade, technology investments must be made in the decade 2013-2022 in order to enable them and reduce their costs and risk. In particular, **it is important to make significant technology investments in the Mars Sample Return Lander, Mars Sample Return Orbiter, Titan Saturn System Mission, and Neptune System Orbiter and Probe.** The first two are necessary to complete the return of samples collected by MAX-C. The Titan Saturn System Mission has the highest priority among the deferred missions to the satellites of the outer planets. Finally, the Neptune System Orbiter and Probe could be an attractive mission for the next decade if the Uranus Orbiter and Probe cannot be flown in the coming decade for some reason. All four missions are technically complex, so early technology investments are important for cost and risk reduction. The technology needs for these missions are discussed in greater detail in Chapter 11.

LAUNCH VEHICLE COSTS

The costs of launch services pose a challenge to NASA's program of planetary exploration. Launch costs have risen in recent years for a variety of reasons, and launch costs today tend to be a larger fraction of total mission costs than they were in the past.

Superimposed on this trend of increasing launch costs are upcoming changes in the fleet of available launch vehicles. The primary launch vehicles likely to be available to support the missions

described above are the existing Delta IV and Atlas V families, plus the Taurus II and Falcon 9 vehicles currently under development (Figure 9.2).

Absent from the list of available vehicles is the Delta II rocket that has been so important in launching past planetary missions. The Delta II, whose production has been terminated, proved to be an exceptionally reliable and relatively inexpensive launch vehicle. Although a few Delta II vehicles not assigned to missions remain, the absence of the Delta II will shortly leave a gap in reliable, relatively inexpensive launch capabilities important for missions to the inner planets and some primitive bodies. New vehicles being developed may help to fill this gap. Orbital Sciences Corporation is developing the Taurus II and Minotaur V, while Space Exploration Technology Corporation (SpaceX) is developing the Falcon 9.

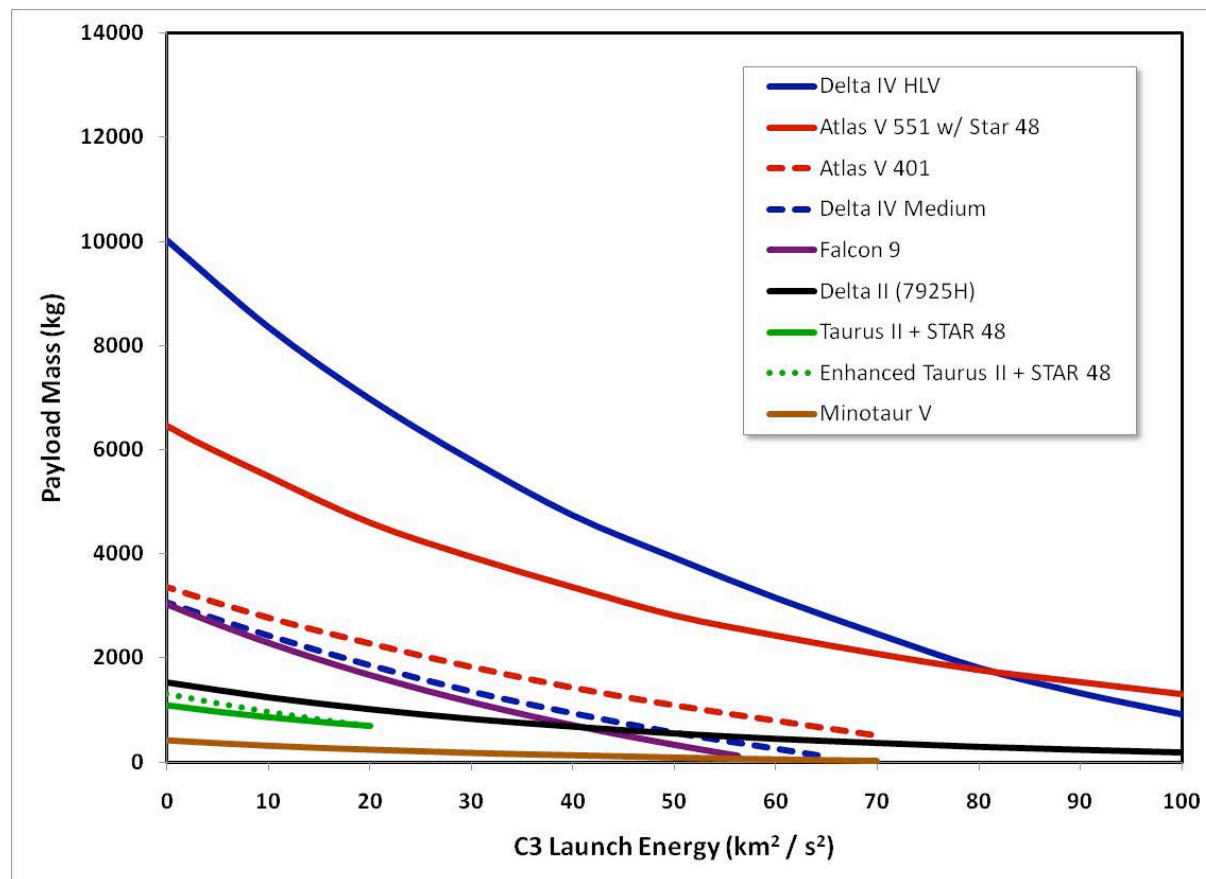

FIGURE 9.2 Performance comparison for launch vehicles likely to be available during the time period covered by this decadal survey, with the soon-to-be discontinued Delta II for comparison. The curves show how each vehicles’ payload mass varies with the C3 parameter—i.e., the square of the hyperbolic excess velocity.

As noted, many past missions have relied on the Delta II, and future missions will not have this option. The concern is that alternative launch vehicles of established reliability, such as the Atlas V and the Delta IV, are substantially more expensive even in their smallest versions. The situation is complicated further by the volatility of the costs of these vehicles, and dependence of costs on future contract negotiations.

Increases in launch costs pose a threat to formulating an effective, balanced planetary exploration program. There may be some ways of partially reducing this threat, although all of them come with their own complexities and disadvantages:

- *Use dual manifesting to reduce individual mission costs.* Combining two missions with complementary scientific objectives onto one launch vehicle reduces costs for each mission. Recent examples of this approach are the Cassini/Huygens mission to Saturn and the Lunar Reconnaissance Orbiter/LCROSS mission to the Moon. This approach, however, does entail additional technical and managerial complications.
- *Use dual manifesting for missions to different destinations.* For example, a planetary mission could be combined with an Earth observation mission. While significant savings may be possible, such a combination of missions would bring substantial technical and management complications, for example resulting from the schedule constraints imposed by planetary launch windows.
- *Buy blocks of launch vehicles across all NASA users to reduce unit costs.* Block procurement of launch vehicles reduces unit costs because of increased production efficiencies both at the prime launch vehicle contractor and at the vendors supplying components and subsystems. According to a 2010 study by the Center for Strategic and International Studies, inefficiency in the US production of launch vehicles adds 30-40 percent to US launch costs.¹⁵ NASA once procured the Delta II in blocks.
- *Buy blocks of launch vehicles across organizations to reduce unit costs.* At present, NASA and the Department of Defense procure launch vehicles separately. Combined procurement across both organizations would result in greater production efficiencies and reduced unit costs. Interagency cooperation to bring about such block buys could be a significant challenge, however.
- *Exploit technologies that allow use of smaller, less expensive launch vehicles.* For some orbital missions to planets with atmospheres, use of aerocapture can result in a substantial reduction spacecraft mass, replacing propellants with a less massive heat shield. For other missions, low-thrust in-space propulsion may enable trajectories that have less stringent launch performance requirements. In both instances, of course, launch savings are partially offset by the cost of the necessary technology development.

THE NEED FOR PLUTONIUM-238

Radioisotope Power Systems (RPSs) are necessary for powering spacecraft at large distances from the Sun, in the extreme radiation environment of the inner Galilean satellites, in the low light levels of high martian latitudes, dust storms, and night, for extended operations on the surface of Venus, and during the long lunar night. With some 50 years of technology development, funded by over \$1 billion, and use of 46 such systems on 26 previous and currently flying spacecraft, the technology, safe handling, and utility of these units are not in doubt.

While there are over 3,000 nuclides, few are acceptable for use as radioisotopes in power sources. For robotic spacecraft missions, plutonium-238 stands out as the safest and easiest to procure isotope that is compatible with launch vehicle lift capabilities.

Past NASA use of plutonium-238 in RPSs is well documented. Future requirement planning is subject to periodic (ideally annual) updates to the Department of Energy. Such plans are complicated by cross-agency budgetary expectations, changing NASA plans, and the competitively selected nature of future NASA missions that may require this isotope.

Unfortunately, production of plutonium-238 in the U.S. ceased in 1988 with the shutdown of the Savannah River Site K-reactor, and separation of the isotope from existing inventories stopped in about 1996. The remaining stock of plutonium-238, largely purchased from Russia, has continued to be drawn down, most recently for the Multi Mission Radioisotope Thermoelectric Generator (MMRTG) on MSL (~3.5 kg of plutonium). An additional potential lien against the remaining supply is the use of plutonium-238 in two Advanced Stirling Radioisotope Generators (ASRGs) on the next Discovery mission (~1.8 kg of plutonium). While an exact accounting of plutonium-238 in the U.S. is not publicly available, previous estimates are consistent with a current supply of ~16.8 kg, not including 3.5 kg now on MSL. Recent NASA requirements reported to DOE are given in Table 9.5.

The projected need decreased from 2008 to 2010 largely due to dropping the lunar rovers associated with the Constellation program (56 kg of plutonium), but also due to a better understanding of requirements. The current plan assumes an additional 10 kg of plutonium-238 will be purchased from Russia, and that an average of 1.5 kg/year of new domestic production can begin, but no earlier than 2015. The Russian purchase is subject to ongoing negotiations, and monies for startup of domestic production were rejected in 2010 by the Congress. Hence, neither of these sources is assured at this time, and without at least 5 kg of new material from Russia as well as renewed production, NASA's current plans for future planetary missions cannot be carried out.

This decadal survey recommends a variety of missions and mission candidates (under the New Frontiers program) that require RPSs. As such, these recommendations would modify NASA's 2010 requirements to some degree. The current supply of plutonium-238 is sufficient to fuel four MMRTGs plus three ASRGs, or 19 ASRGs, or cases in between.

TABLE 9.5 Comparison of NASA Requirements for Plutonium-238 as Reported to DOE in 2008 and 2010

Mission	NASA Administrator Letter of 29 Apr 2008			NASA Administrator Letter of 25 Mar 2010		
	Projected Launch	Power (We)	Pu-238 Usage (kg)	Projected Launch	Power (We)	Pu-238 Usage (kg)
Mars Science Lab	2009	100	3.5	2011	100	3.5
Lunar Precursor	Not in plan			2015	280	1.8
Mars (RPS and Heater Units)	Not in plan			2018	280	1.8
Outer Planets Flagship 1	2017	700-850	24.6	2020	612	21.3
Discovery 12	2014	250	1.8	2015	280	1.8
Discovery 14	2020	500	3.5	2021	280	1.8
New Frontiers 4	2021	800	5.3	2022	280	1.8
New Frontiers 5	2026	250-800	1.8-5.3	2027	280	1.8
Discovery 16	2026	500	3.5	2027	280	1.8
Outer Planets Flagship 2	2027	600-1000	5.3-6.2	Deleted from plan		
Pressurized Rover #1	2022	2000	14	Projected ESMD requirements deleted for human missions		
ATHLETE Rover	2024	2000	14			
Pressurized Rover #2	2026	2000	14			
Pressurized Rover #3	2028	2000	14			

The largest user of plutonium-238 is any mission that baselines MMRTGs rather than ASRGs. Currently this only applies to JEO, for which five MMRTGs are baselined—i.e., one more than can be supported by the current supply of Pu-238. The Titan Saturn System Mission is the only other mission that baselines MMRTG use, and it is deferred until the decade subsequent to this study.

None of the recommended Mars missions use an RPS. Of the potential New Frontiers missions requiring RPSs, Io Observer requires two ASRGs, LGN four, Saturn Probe two, and Trojan Tour and Rendezvous two. Hence, a maximum of six ASRGs for two New Frontiers missions brackets potential requirements. The Uranus Orbiter and Probe and the Enceladus Orbiter each require three ASRGs, and cannot be carried out with MMRTGs due to the latter's prohibitive mass. Discovery 12 is needed to qualify ASRGs, and Discovery 14 and 16 could potentially use these as well—each is currently baselined

with two. Hence, 15 ASRGs and five MMRTGs are implied by the recommended decadal survey plan presented above; the cost-constrained plan would require only 15 ASRGs.

The recommended program cannot be carried out without new plutonium-238 production or completed deliveries from Russia. The cost-constrained program could be, but only if ASRGs work as currently envisioned and are certified for flight in a timely fashion. Moreover, unless additional plutonium-238 is acquired, there will be only three ASRGs available for the subsequent decade, so there will not be a Europa mission, a Titan Saturn System Mission, a mission to Neptune, or long-lived mission to the surface of Venus in future decades. There are no technical alternatives to plutonium-238, and the longer the restart of production is delayed, the more it will cost.

As noted above, the largest projected user of plutonium-238 in the recommended program is JEO. Because the use of MMRTGs on JEO would consume so much of this valuable resource, **the committee recommends that JEO use ASRGs for power production.** The duration of JEO is compatible with ASRG use, and this change would alleviate (though not solve) the immediate plutonium-238 crisis. In addition, because ASRGs are so broadly important to the future of planetary exploration, the committee recommends that the remaining ASRG development and maturation process receive the same priority and attention as a flight project.

All findings in the recent NRC report on RPSs remain valid.¹⁶ With the one exception of NASA issuing annual letters to the DOE defining the future demand for plutonium-238, none of the recommendations of that report have been adopted. A decision to wait to a “better time” to fund activities required to restart domestic plutonium production is just a different way of ending the program, eliminating future science missions dependent on this technology for implementation.

The committee is alarmed at the status of plutonium-238 availability for planetary exploration. Without a restart of plutonium-238 production, it will be impossible for the United States, or any other country, to conduct certain important types of planetary missions after this decade.

OPPORTUNITIES FOR INTRA-AGENCY, INTERAGENCY, AND INTERNATIONAL COLLABORATION

There are three main areas in which collaboration with other parts of NASA could benefit the solar system exploration program. First, as noted above, block buys of launch vehicles across NASA have the potential to lower launch costs significantly. Second, astronomical telescopes, both ground-based and space-based, can be used to observe solar system targets. The Hubble Space Telescope has a long history of successful planetary observations, and this collaboration can be a model for future telescopes such as the James Webb Space Telescope.

A third area of possible intra-agency collaboration is with NASA’s Exploration Systems Mission Directorate (ESMD). NASA’s plans for future human exploration of the solar system currently include ESMD-funded robotic precursor missions to the Moon, Mars, and asteroids. Because their focus is preparing for human exploration, rather than science, these are not substitutes for any of the missions recommended above, nor for Discovery missions. And, while they present opportunities for collaboration, NASA’s Planetary Science Division should be cautious about imposing mission-defining requirements, as we noted in Chapter 2. At the start of mission formulation, ESMD should inform the science division what mission resources, if any, they are willing to allocate. Then, given a negotiated agreement between ESMD and SMD, NASA should offer opportunities for scientists to propose investigations on such missions by issuing Announcements of Opportunity in a manner similar to that for participating on international missions or as was done for LRO.

Because ESMD robotic precursor missions target planetary bodies, they offer particularly good opportunities for launch cost reduction via co-manifesting.

The greatest potential for interagency collaboration is also launch vehicle block buys and co-manifesting, reducing costs for all partner agencies. It will also be important for NASA to form a strong

partnership with the Department of Energy in order to obtain the plutonium-238 needed for upcoming planetary missions.

International collaboration is possible in many forms, and offers significant opportunities to strengthen NASA's solar system exploration program. Missions of Opportunity allow US investigators to participate in missions flown by non-US space agencies, and should be pursued vigorously. The science of Discovery and New Frontiers missions can be enhanced at modest instrument accommodation cost to NASA by including instruments and investigators from other nations. As the capabilities of many potential international partners around the world grow, these opportunities will multiply.

All three of the Flagship missions in the recommended program have the potential for substantial international collaboration. EJSM would be done collaboratively with ESA, flying both the NASA Jupiter Europa Orbiter and the ESA Jupiter Ganymede Orbiter. These coordinated missions are a good example of a robust international partnership. There are no complex hardware interfaces between the two major international components. Each mission can stand alone on its own scientific merits, but the two conducted jointly can complement and enhance one another's science return by making synergistic observations. And each would carry an international payload, making the most capable scientific instruments available to each, regardless of their nation of origin.

MAX-C is envisioned to be an international mission, with both the NASA sample collection rover and the ESA ExoMars rover delivered by a NASA-provided derivative of the MSL EDL system. Moreover, it is intended to be the first element of a three-mission Mars Sample Return campaign, with ESA playing a significant role throughout the entire campaign. Unlike EJSM, the interfaces between NASA and ESA elements of MAX-C (and, perhaps, the follow-on elements as well) are complex, and will have to be managed with great care. As noted above, a particular concern for MAX-C is that an attempt to accommodate two large and capable rovers as currently imagined would be likely to force a costly redesign of the MSL EDL system. In order to keep NASA's costs for MAX-C below the recommended \$2.5 billion (FY2015), significant reductions in mission scope, including major reductions in landed mass and volume, are likely to be necessary. So while MAX-C offers an opportunity for international collaboration, that collaboration must be managed carefully.

The Uranus Orbiter/Probe mission has not yet been discussed as an international collaboration, but it offers significant potential. As one example, the instrument payload could be selected internationally, strengthening the science while reducing costs to NASA.

NOTES AND REFERENCES

1. National Research Council, *New Frontiers in the Solar System: An Integrated Exploration Strategy*, The National Academies Press, Washington, D.C., 2003.
2. National Research Council, *Opening New Frontiers in Space: Choices for the Next New Frontiers Announcement of Opportunity*, The National Academies Press, Washington, D.C., 2008.
3. For a well documented case see, for example, *Independent Comprehensive Review Panel, James Webb Space Telescope (JWST) Independent Comprehensive Review Panel (ICRP): Final Report*, NASA, Washington, D.C., 29 October 2010. Available at http://www.nasa.gov/pdf/499224main_JWST-ICRP_Report-FINAL.pdf.
4. National Research Council, *An Assessment of Balance in NASA's Science Programs*, The National Academies Press, Washington, D.C., 2006.
5. National Research Council, *Decadal Science Strategy Surveys: Report of a Workshop*, The National Academies Press, Washington, D.C., 2007.
6. For a graphic example of the damage potential of cost growth see, for example, Table 3.1 of National Research Council, *Decadal Science Strategy Surveys: Report of a Workshop*, The National Academies Press, Washington, D.C., 2007.

7. National Research Council, *An Assessment of Balance in NASA's Science Programs*, The National Academies Press, Washington, D.C., 2006.
8. National Research Council, *Controlling Cost Growth of NASA Earth and Space Science Missions*, The National Academies Press, Washington, D.C., 2010.
9. National Research Council, *Controlling Cost Growth of NASA Earth and Space Science Missions*, The National Academies Press, Washington, D.C., 2010, p. 38.
10. Note that the CATE costs for these missions presented in Appendix C include launch-vehicle costs. While some CATE estimates (minus launch-vehicle costs) exceed the recommended \$1.0 billion cost cap, all were judged by the committee to be close enough to the cap that a PI and team could adjust their scope so that they could fit within the cap.
11. National Research Council, *Opening New Frontiers in Space: Choices for the Next New Frontiers Announcement of Opportunity*, The National Academies Press, Washington, D.C., 2008.
12. This is the cost of MAX-C only, not the cost of the full Mars Sample Return campaign. Also, the estimate is for the MAX-C mission as currently conceived; below we recommend reductions in scope to keep the cost below \$2.5 billion FY2015.
13. Version without solar-electric propulsion stage.
14. Jupiter Europa Orbiter Mission Study 2008: Final Report—The NASA Element of the Europa Jupiter System Mission (EJSM), Jet Propulsion Laboratory, Pasadena, CA, Applied Physics Laboratory, Laurel, MD, and European Space Agency, Paris, France, 30 January 2009.
15. Ben Ari et al., *National Security and the Commercial Space Sector*, 2010.
16. National Research Council, *Radioisotope Power Systems: An Imperative for Maintaining U.S. Leadership in Space Exploration*, The National Academies Press, Washington, DC, 2010.

10

Planetary Science Research and Infrastructure

NASA planetary missions are the most visible aspect of the agency's solar system exploration program. While missions get the lion's share of the public's attention, they are supported by an infrastructure and research program that is vital for mission success. These research activities also generate much of the planetary program's science value on their own, independent of individual missions.

Funding for scientific planning and technological development as precursors to missions, for data analysis and theoretical interpretations during and after each mission's operational phase, and for data archiving and sample curation are provided through NASA's Supporting Research and Analysis (SRA) programs. The central roles of supporting research and related activities at NASA and their relevance to the quality of the space exploration program have recently been described and analyzed by the NRC Committee on the Role and Scope of Mission-Enabling Activities in NASA's Space and Earth Science Mission. The committee strongly supports the recommendations of that committee's report.¹

Given the importance of the diverse activities sponsored by SRA funding, the report cited above raises a concern regarding the ability of a small staff in the NASA Science Mission Directorate to handle its responsibilities, suggesting that it is not adequately sized. The committee echoes this concern and, in particular, highlights and endorses a key finding of the report, which states: "The mission-enabling activities in NASA's Science Mission Directorate (SMD)—including support for scientific research and research infrastructure, advanced technology development, and scientific and technical workforce development—are fundamentally important to NASA and to the nation."

Table 10.1 summarizes the key findings and recommendations from Chapters 4-8 that are related to planetary science research and infrastructure.

SUPPORTING RESEARCH AND RELATED ACTIVITIES AT NASA

Planetary spacecraft return data, but these data only have value when they are interpreted. Interpretation of data requires sophisticated analysis, theoretical investigations, and computer simulations. These activities are supported at NASA through grants to investigators made by Research and Analysis programs. Data are archived and distributed to scientists worldwide by the Planetary Data System. And scientific results are conveyed to the most important stakeholders in planetary exploration—the taxpayers who funded it and the students who will help assure its future—via the Education and Public Outreach Program. The health of all these SRA programs is vital to planetary exploration.

TABLE 10.1 Key Research and Infrastructure Findings and Recommendations from Chapters 4-8

	Chapter 4 The Primitive Bodies	Chapter 5 The Inner Planets	Chapter 6 Mars	Chapter 7 The Giant Planets	Chapter 8 Satellites
Ground-based Telescopes	Assure access to large telescopes for planetary science observations. Maintain the capabilities of Goldstone and Arecibo radar systems.	Support building and maintaining Earth-based telescopes.		Assure access to large telescopes.	
Laboratory Research/ Research Support	Continue funding of programs to analyze samples of primitive bodies in hand and develop next-generation instruments for returned samples.	Strong R&A program is critical. Investigate modeling a cross-disciplinary program after the existing Mars Climate Modeling Center.	Vigorous R&A programs are needed to enhance the development and payoff of missions and refine the sample collection requirements and laboratory analysis techniques needed for MSR.	Maintain robust programs of data analysis, laboratory work and computational development.	
Data Archiving	Support the ongoing effort to evolve the Planetary Data System.	Continue to evolve the Planetary Data System and Deep Space Network.		Support the ongoing effort to evolve the Planetary Data System.	
Education and Public Outreach		Strengthen efforts to archive past efforts.			

Research and Analysis Programs

The research related to planetary missions begins well before a mission is formulated and funded, and continues long after it is over. Research provides both the foundation for interpreting data collected by spacecraft as well as the guidance and context for identifying new scientifically compelling missions.

Research and analysis programs allow the maximum possible science return to be harvested from missions. Along with analysis of spacecraft data, their portfolios include laboratory experiments, theoretical studies, fieldwork using Earth analogs, planetary geologic mapping, and analysis of data from Earth-based telescopes. Important examples of supporting laboratory work include characterization of extraterrestrial materials and collection of spectroscopic data sets (for more representative coverage of solar system objects), experimental investigation of the states and behaviors of materials and planetary and space environments, and analog experiments (e.g., fluid dynamics experiments). Scientific and technical advances derived from these programs are used to identify important goals for future exploration, determine the most suitable targets for space missions, and develop and refine the instrumental and analytical techniques needed to support new missions.

Through the direct involvement of students and young investigators, they help train future generations of space scientists and engineers. The recommended missions in Chapter 9 were derived from the key science questions in Chapter 3, and those questions were informed primarily by the results of the research and analysis programs.

The scientific return from a mission increases when investigators outside the mission teams synthesize data from multiple missions, test new theoretical insights, and link observations from different sources in interdisciplinary investigations. New interdisciplinary fields, such as planetary climatology and exoplanet studies, are emerging as a consequence.

The Level of Research and Analysis Support

All of these fields of research are important to NASA's long-term planetary science goals, and all require funding. This funding not only leads to the gathering and dissemination of new scientific knowledge, it also lays the groundwork for the future of the field. In particular, the use of NASA SRA funds to support graduate students and provide early career fellowships for new Ph.D.s is crucial for developing and maintaining the workforce that will explore the solar system in the coming decades. Historically this burden of funding has fallen almost entirely on NASA, as it will for the foreseeable future. As noted in the NRC's *Enabling Foundation* report cited above, "In the case of planetary science, NASA is by far the principal sponsor of research, and thus programs supported by other agencies are not a major factor."²

Current NASA research and analysis funding in most programs supporting planetary research is distributed as multiple small grants. An unfortunate and very inefficient aspect of this policy is that researchers must devote an increasingly large fraction of their time to writing proposals instead of doing science. Over the 7 fiscal years 2003-2009, an average of 37 percent of the grant proposals submitted to an average of 18 or 19 programs in NASA's Planetary Science Division have been supported. The success ratio is lower than desirable but the negative impact of the low success rate on the science community is magnified by the small grant policy; many researchers seeking support for themselves and/or their students must submit half a dozen proposals each year to make ends meet. The problem of raising funds is especially challenging for soft money researchers who must find support for their own salaries as well as for direct research expenses. Numerous previous reports have noted that this effort is highly inefficient and stressful to the research community. This burden on the community is then compounded by the substantial and growing further effort required to review all of these proposals. **The committee strongly encourage NASA to find ways (e.g., by merging related research programs and lengthening award periods) to increase average grant sizes and reduce the number of proposals that must be written, submitted, and reviewed by the community.**

Another clear message from study of the SRA programs is that the number of good ideas for research surpasses the funding available to enable that research. More funding for research and analysis would result in more high-quality science being done. However, recommendations for increased research funding must be tempered by the realization that NASA's resources are finite, and that such increases will inevitably cut into funds that are needed to develop new technologies and fly new missions. So an appropriate balance must be sought. After consideration of this balance, and consistent with the mission recommendations and costs presented in Chapter 9, **the committee recommends that NASA increase the research and analysis budget for planetary science by 5 percent above the total finally approved FY2011 expenditures in the first year of the coming decade, and increase the budget by 1.5 percent above the inflation level for each successive year of the decade.** This modest increase will allow the scientific benefits of NASA's planetary missions to be reaped more fully, while still permitting the vigorous program of planetary missions and related technology development described in Chapters 9 and 11 respectively to be carried out. In addition,

NASA should periodically evaluate the strategic alignment and funding level of all its SRA programs to ensure they remain healthy and productive.

Mission Flight Teams

The science return from planetary missions, especially complex ones like Flagship missions, is maximized by effective communication and data sharing among all the scientists involved in the mission. Science teams for large missions should be put together so that data sharing is built into the mission structure from the outset, and free data access among all instrument teams on a mission should be strongly encouraged. Such policies should be defined in the Announcement of Opportunity so that teams are aware of them and can plan for them from the start. Where science instruments are competed, there should be mechanisms, such as an interdisciplinary scientist or participating competition after instrument selection, to allow the most qualified scientists to be part of the mission even if they are not members of a selected instrument team. Particular attention should be paid to addition and full participation of younger scientists in long-duration missions.

Theory and Modeling

Theory and modeling play an important and growing role in planetary science. Simulations have strong visual appeal, can clarify complex processes, and can test hypotheses. Numerical modeling is an essential tool for extracting information from spacecraft observations by explaining new phenomena. Such modeling must be based on physical principles, validated with spacecraft data and, in many cases, must be supported by additional laboratory measurements. General circulation models (GCMs) for the atmospheres of Mars, Venus, Titan, and the giant planets are one of the best examples of the interplay between data and theory. These circulation models are fundamental tools in the study of planetary atmospheric processes. They are also useful as mission planning tools, for example in predicting the winds that will be encountered by planetary entry probes and landers.

Significant advances in many planetary fields have occurred during the past decade largely due to the availability of increasing computing power and more sophisticated software, but also because of improved understanding of physics and chemistry. Examples include the following:

- Improved modeling of planetary accumulation process and how they relate to the isotopic constraints on cosmochronology,
- Efforts to relate observable aspects of bodies (e.g., tectonics, volcanism, and magnetic fields) to internal state and evolution,
- Models for tidal heating and plumes on Enceladus,
- Impact dynamics and the physical processes in small bodies,
- Magnetohydrodynamic models that provide insight into the dynamical responses within the magnetospheres that envelop Jupiter and Saturn,
- Modeling of orbital histories (e.g., the accumulation of bodies, the delivery of meteoroids, the solar system's structure, and a lunar impact origin),
- Identification of chaos (e.g., mean-motion and secular resonances and their overlap) in the solar system, and
- The inclusion of moist convection and cloud microphysics in atmospheric modeling.

Although many of the processes of interest have Earth analogs and well-developed codes for Earth science problems, planetary applications often require going far beyond terrestrial experience and validation of codes in unusual situations is often needed.

Theoretical development and numerical modeling are crucial for planning future planetary missions, as well as for maximizing the scientific return from past and ongoing missions.³ For example, the stability of the jovian jet streams is a major topic of theoretical research, and it has recently been applied to predict the bulk rotation rate of Saturn.⁴ The theory and modeling of two-dimensional turbulence have advanced understanding of spatial scales of jets and vortices.⁵ The investigation of the hydrogen equation of state has a major theoretical component involving molecular dynamics modeling.⁶ Detailed modeling of planetary rings requires both analytical and numerical calculations.⁷ As scientists plan for new missions to these bodies—such as the various missions evaluated for this Survey—they incorporate this work into their plans and requirements.

Primitive bodies research also depends heavily upon theory and modeling in part because the objects are so diverse and their numbers so vast. Fundamental theoretical investigations and numerical modeling are essential to the understanding of primitive bodies and the processes through which they evolve. For example, both were needed to begin to understand how the structure of the Kuiper belt has evolved through time. Both were also needed to address important processes that cannot be studied directly in the laboratory such as the collisions between asteroid-sized bodies.

Computing

As mission data sets become larger and more diverse, and as understanding of integrated planetary systems increases and models become more complex, the computing power required for data analysis and simulation is growing. Research tasks that require large computational resources include dynamical studies of planet formation, atmospheric GCMs, planetary interior convection and dynamo models, thermodynamic first-principle calculations to determine equations of state, simulations of solar wind-magnetosphere interactions, hydrocode simulations of impacts, and image processing.

Additional funds to maintain and upgrade large, centralized supercomputing facilities at NASA centers will be required in the coming decade. It is equally important to broaden the access to and to streamline data pipelines from these facilities to accommodate the exponentially increasing need for data and information. The right balance must be struck between providing funds for the purchase of powerful computing hardware and funding the technical staff support needed to utilize these facilities with optimum efficiency.

Complementing the large NASA computational facilities, revolutionary improvements have been made in recent years in the computing capabilities of servers that are commercially available and accessible to individual researchers. These advances have enabled substantial cost-effective progress in computations that in the past were possible only on large supercomputers. Support should be made available to permit acquisition of such computing facilities by individual principal investigators where appropriate.

Data Distribution and Archiving

Data from space missions remain scientifically valuable long after the demise of the spacecraft that provided them, but only if they are archived appropriately in a form readily accessible to the community of users and if the archives are continually maintained for completeness and accuracy. Data curation is particularly critical for planetary missions, which are infrequent, costly, and often capture temporally unique planetary snapshots. NASA has for many years recognized its responsibility to archive data from planetary missions and make them widely available to the research community. The first analysis of newly acquired spacecraft data is often part of the spacecraft mission budget, but full analysis requires many years of thoughtful work. Some of the most

important advances are often the result of analyses carried out using data archives supported by the SRA program years or even decades after a mission has ended.

The Planetary Data System (PDS) provides the critical data archiving and distribution function to the planetary science community. Over the last 20 years, the PDS has established a systematic protocol for archiving and distributing mission data that has become the international standard. **It is crucial that the capabilities of the Planetary Data System be maintained by NASA, both to provide a permanent archive of planetary data and to provide a means of distributing those data to the world at large.** It is also essential that newly acquired data continue to be archived and made accessible to the science community within no more than 6 months following receipt and validation. For data from ground-based or international partner instruments, contractual agreements should be used to assure the timely delivery of such data to the PDS (sometimes within funding agreements from specific supporting research and analysis programs). The PDS should also consider developing requirements for data archiving by small groups who have implemented creative data processing that enhances the value of existing planetary data sets.

High-level data products must be archived along with the low-level products typically produced by instrument teams. **For future missions, Announcements of Opportunity (AOs) should mandate that instrument teams propose and be funded to generate derived products before missions have completed Phase E.** In the interim, separate support should be provided for development of high-level data products in cases where such support cannot be provided by mission funding.

Use of the appropriate standards is essential to enable synergistic application of planetary data sets. Over the past two decades the development of the Navigation and Ancillary Information Facility (NAIF) at JPL, together with the evolving standards associated with SPICE kernels—i.e., specific data files containing ancillary information relating to the orientation, location, operating mode, and other operating characteristics relevant to how data from a particular spacecraft instrument was collected—have greatly streamlined and standardized planning, acquiring, and archiving information about observations. The NAIF facility and SPICE kernels should continue to be used, and NASA planetary missions should adopt SPICE as a standard during mission planning, operations, and archiving. Development of standards for geodetic and cartographic coordinate systems should to be encouraged, and these systems should be documented and archived within a NAIF/SPICE framework.

With expected large increases in data volume during the next 10 years, PDS capabilities will have to expand. The existing PDS is very much a product of its original decade of creation. The planned PDS upgrade will better leverage modern databases and web services, creating an on-line resource that will serve the more complex needs of modern science user communities. New types of data, like pertinent laboratory measurements and telescopic data, could be added where appropriate. Periodic reviews, as already performed, will ensure that the science communities' needs are met. A balanced SRA program will allow for further development of related public domain software, such as OLAF (for data ingestion) and ISIS (image manipulation and mosaicking), and a coordinated set of standards (geodetic, cartographic maps, and other systems). And, as planetary exploration continues to become a more international enterprise, it will be increasingly important for NASA to assure interoperability of the PDS with other international repositories of planetary data.

Communicating With the Public: Education and Outreach

The tremendous public interest in planets and planetary exploration points to a deeply rooted resonance between the work done by planetary scientists and the broader populace. In its most grand sense, planetary exploration challenges us all to be curious about the world in which we live. Such curiosity can lead to a greater appreciation of the role of that science in general and planetary science in particular can play in fostering a vigorous and economically healthy nation.

PREPUBLICATION COPY—SUBJECT TO FURTHER EDITORIAL CORRECTION

Defining the Need

Jon Miller, in his paper entitled *Civic Scientific Literacy across the Life Cycle*, states that only 30 percent of the U.S. population is scientifically literate.¹ This scientific illiteracy extends even to the most basic facts about our universe. For example, the National Science Board estimates that more than a third of Americans do not understand that Earth orbits the Sun.² The United States is losing its scientific and technological competitiveness, a situation that can only be reversed if science literacy and proficiency become a national priority.³

The role that science can play in economic development was articulated in the NRC's 2007 and 2010 reports *Rising Above the Gathering Storm: Energizing and Employing America for a Brighter Economic Future*⁸ and *Rising Above the Gathering Storm, Revised: Rapidly Approaching Category 5*.⁹ These reports argue that the science and technology that powers the U.S. economy is not adequately funded, and does not attract as many practitioners as it does in other countries. The specific recommendations from the first *Gathering Storm* report can be succinctly summarized as:

- Increase America's talent pool by vastly improving K–12 science and mathematics education;
- Sustain and strengthen the nation's commitment to long-term basic research;
- Make the United States the most attractive setting in which to study and perform research; and
- Ensure that the United States remains a leading place in the world to innovate.

Exploration of the planets can play a key role in addressing these challenges, because it is among the most exciting and accessible scientific activities funded by NASA, and indeed by any government agency. NASA's planetary program has a special opportunity, and therefore a special responsibility, to reach out to the public. Planetary exploration research has today with many other areas of science, technology, engineering, and mathematics: geology, chemistry, biology, aerospace engineering, high-performance computing, electrical engineering and advanced optics, and computer science. Planetary exploration offers a return on investment for the United States, by attracting young people to science and technology careers and providing the kind of education and training that can help solve major societal challenges involving science and technology. Public interest in the exploration of the solar system translates to opportunities to educate and influence future scientists, engineers, teachers, policy makers, and the public at large, through classroom instruction or informal education.

In addition to the *Gathering Storm* report, the America COMPETES Act also highlighted three areas of importance to the nation; planetary exploration can contribute directly to these areas.

1. *To strengthen research investment and to foster innovation and frontier research.* Planetary exploration research is transformative at the most fundamental level, exploring areas as far-reaching as the origin of life, the origins of the solar system, the evolution of planetary environments, and the search for Earth-like planets in other solar systems. Planetary exploration can drive innovation in technology such as advanced sensors and data processing.
2. *To strengthen educational opportunities in science, technology, engineering, and mathematics (and critical foreign languages).* Planetary science has broad public appeal and vibrant

¹ Jon D. Miller, *Civic Scientific Literacy across the Life Cycle*, a paper presented at the annual meeting of the American Association for the Advancement of Science, San Francisco, California, February 17, 2007.

² The National Science Board, *Science and Engineering Indicators 2006*, National Science Foundation, Arlington, Va., available at <http://www.nsf.gov/statistics/seind06/pdf/volume1.pdf>.

³ NAS, NAE, IOM, *Rising Above the Gathering Storm*, 2007.

ties to other branches of science and technology, enabling the field to contribute to science education in uniquely powerful ways. Planetary exploration is also increasingly an international endeavor.

3. *To develop a workforce for the 21st century.* Planetary exploration can play a central role in raising U.S. science literacy at all levels from kindergarten through university, and within the general public as well.⁴ Many of the breakthroughs being made in our understanding of the solar system involve close connections with other scientific fields such as geology, geochemistry, and biology, developments which also find increasing application in our everyday lives.

Education and Outreach Opportunities

Technological advances over the past decade have dramatically changed the nature of public outreach. Nearly instant public availability of raw images from planetary missions, and global access to planetary data, feeds growing online communities of committed space enthusiasts. Interested members of the public can be informed of discoveries and mission events as they happen through social media. At the same time, the decline of traditional science journalism, with its ability to synthesize results into a coherent whole and present them to a mass audience, and the ever-accelerating news cycle, may erode scientific understanding by the public. It is crucial, then, for scientists themselves to make their work and findings comprehensible, appealing, and available to the public.

The federal government provides significant support for many informal education and outreach activities. In the past, NASA devoted roughly one percent of the cost of major missions to education and public outreach and created imaginative websites and activities concerning its missions to engage students, teachers, and the public.

Although the funding for education and public outreach by NASA increased from 1996 to 2004, it has leveled off in the past half decade. Recent National Research Council studies have indicated that for a better return on the federal investment in education and public outreach, a more rigorous program of assessment is needed of outcomes and efficacy across the entire spectrum of space science education and public outreach activities.⁵ This is particularly important in the many less formal outreach activities.⁶

Much effort is required to transform raw scientific data into materials that inform and appeal to the general public. NASA planetary science funding is used for education and public outreach activities based on the discoveries of planetary missions. Efforts to integrate effective outreach should be directly embedded within each planetary mission. **The committee strongly endorses NASA's informal guideline that a minimum of 1 percent of the cost of each mission be set aside from the project budget for education and public outreach activities.** Modest additional funding must also be set aside to convey to the public the important scientific results from the longer-term supporting research and analysis programs, and individual scientists should be strongly encouraged to participate in communicating the research of their research broadly.

The committee also encourages organizing and maintaining NASA's educational efforts, matched to national educational standards, through science education and public outreach forums, formal content review, and newly evolving product databases. Local efforts, in addition to national

⁴ Education in STEM as important areas of competency is emphasized in, for example, the America COMPETES Act (H.R. 2272), initiatives within the U.S. Department of Education and National Science Foundation, and in *Rising Above the Gathering Storm: Energizing and Employing America for a Brighter Economic Future*, a report of the National Academy of Sciences, National Academy of Engineering, and Institute of Medicine (The National Academies Press, Washington, D.C., 2007).

⁵ National Research Council, *NASA's Elementary and Secondary Education Program: Review and Critique*, The National Academies Press, Washington, D.C., 2008.

⁶ As highlighted in National Research Council, *Learning Science in Informal Environments: People, Places, and Pursuits* (P. Bell, B. Lewenstein, A.W. Shouse, and M.A. Feder, eds.), The National Academies Press, Washington, D.C., 2009.

efforts, can help assure compatibility of scientifically rigorous educational materials with state-by-state curriculum needs. NASA's efforts leverage the agency's expertise and engaging content, and have a strong record of producing innovative curricula for schools and programs for other venues.¹⁰

NASA INSTRUMENTATION AND INFRASTRUCTURE

Instrument Development

Planetary missions rely heavily on technology. Nowhere is this more true than in the technology for new scientific instrumentation, which can revolutionize the science returned by a mission. Chapter 11 contains an in-depth discussion of technology development for planetary missions, including new scientific instruments. In particular, that chapter advocates a dedicated technology funding line that, among other things, will fill the need to develop new flight instruments to a higher level of technological readiness than has been the norm in the past. NASA's Planetary Instrument Definition and Development Program (PIDDP) has been very successful in initiating many new instrument concepts and maturing them to low technology readiness levels (TRL). The technology program called for in Chapter 11 will provide the funding to bring the most promising low-TRL instrument concepts to the point where they can be reliably selected for flight, reducing mission cost and schedule risk.

Each planetary environment is unique, and each instrument flown on a planetary mission must be customized to some degree for the mission and planetary target. Every future mission will be enabled or enhanced by improvements in instrument miniaturization and advanced electronic component design. Both remote and in-situ instruments will benefit from improved technologies and components. Significant development is needed, in particular, for in-situ instruments for sample selection and handling, age dating, organic detection and characterization, isotopic identification, and instruments that function in extreme environments of temperature, pressure and high radiation. Semi-autonomous sample handling and manipulation offers significant challenges in any environment, and operation in extreme environments makes it all the more challenging.

The mission studies performed for this decadal survey (Appendix G) resulted in over 50 specific instruments cited in strawman payloads. These instruments range widely in their design requirements due to the unique conditions of each target body. Examples of the most commonly mentioned measurements and instrumentation and selected areas where development or improvements should be supported are summarized in Table 10.1. This table is not intended to be comprehensive, but only representative. All of these instrument types are candidates for future development under the technology program described in Chapter 11. It is, of course, important for instrument development funding to be tied to specific future missions and goals.

For further discussion and recommendations regarding instrument development and its role in NASA's broader planetary technology development program, see Chapter 11.

TABLE 10.1 Commonly Cited Improvements and/or Technology Developments Required in Measurements and Instrumentation Mentioned in the Mission Studies Performed in Support of This Decadal Survey. The mission study reports are available in Appendix G.

Commonly Cited Instruments	Increased Resolution or Sensitivity	Mass Reduction	Radiation Resistance	Ability to Operate in Extreme Environments
Imaging Systems	X	X	X	X
Ultraviolet/Visible/Infrared/Raman Spectroscopy	X	X	X	X
Tunable Laser Spectrometer Spectroscopy	X	X	X	X
Laser Ranging	X	X	X	
Radar/Synthetic Aperture Radar/Interferometric SAR	X	X	X	
Seismometer	X	X		X
Heat Flow	X	X		X
Radio Sounder	X	X		
Mass Spectrometer	X	X	X	X
Atmospheric Sounder	X	X		
Gamma/Neutron Spectroscopy	X	X		
Plasma	X	X	X	
Particles/Dust Analyzer	X	X	X	
Nephelometer	X	X		
Magnetometer	X	X	X	
Ultra-Stable Oscillator	X	X		
Surface Sampling and Handling		X		X
Subsurface Sampling		X		X
Cryogenic Handling		X		X

NASA Telescope Facilities

Most bodies in the solar system were discovered using telescopes. Utilization of the enormous discovery potential of telescopes is an essential part of our integrated strategy for solar system exploration. Major scientific findings have been made in recent years using Earth-based telescopes. As just one important example, the discovery of extrasolar planets has had a major impact on researchers' perceptions of the solar system.

Many spacecraft missions, including ones recommended in this report, are designed to follow up on discoveries made using telescopes. Recent telescopic observations of Uranus, for example, have demonstrated that the ice giant's atmosphere undergoes changes that were not apparent during the Voyager 2 flyby in the 1980s. The Kuiper Belt was revealed in the 1990s as a vast, unexplored, and previously only postulated, "third domain" of the solar system beyond the realms of the terrestrial and giant planets. Even the still-preliminary understanding of the dynamics of the objects beyond Neptune has led to wide acceptance of the outward migration of Neptune early in the solar system's

history. And telescopic observations were largely responsible for the reported detection of methane in the atmosphere of Mars.

Telescopes also help identify targets to which spacecraft missions can be flown. A key example of a “found” population is that of the near-Earth objects (NEOs), which are now understood to pose a potential impact threat to Earth, but also to be exploitable for both sample return and as springboards for future human exploration missions. NEOs are particularly attractive targets for spacecraft missions because many require lower energy trajectories than do most planetary bodies.

Earth-based telescopes also provide ongoing support for spacecraft missions, both before and after the mission. Particularly effective examples were the global observing campaign that supported the Deep Impact mission to comet Tempel 1 and the impact of LCROSS on the Moon. And, in a much broader sense, Earth-based observations provide the context for nearly all mission results. For example, Earth-based studies alone have allowed taxonomic systems for asteroids and comets to be developed.

Although most government-supported telescope facilities in the United States are funded by the National Science Foundation (see below), NASA continues to play a major role in supporting the use of Earth-based optical and radar telescopes for planetary studies. Subsequent sections discuss ground-based, airborne, and orbital telescopes that support planetary science using NASA funding.

NASA Infrared Telescope Facility

NASA provides operational support for the 3-meter Infrared Telescope Facility (IRTF) on Mauna Kea, Hawaii, for observational programs with an emphasis on support for planetary and astrophysics space missions. The planetary science community has special needs for access to ground-based telescope facilities that differ from the requirements for stellar and extragalactic astronomy. Among these needs are the ability to observe bright targets, and flexible scheduling for unpredictable or time-dependent phenomena, such as studies of comets, planetary impacts, Earth-approaching asteroids, and unexpected cloud activity on planets. In addition, many solar system targets are frequently observable only at small angular separation from the Sun, requiring capabilities for daylight and near-horizon observations. At present and in the foreseeable future, the IRTF is the only observatory that is designed and operated primarily to meet the broad needs of planetary investigations. The IRTF meets the needs of planetary astronomy through continuing telescope and instrument upgrades (supported also by the NSF), expanded capabilities for remote observing, and flexible scheduling.

W.M. Keck Observatory

The Keck Observatory, consisting of twin 10-meter telescopes on Mauna Kea, is supported in part by NASA in partnership with the University of California and the California Institute of Technology. A fraction of Keck telescope time is allocated specifically for NASA programs, with much of that time devoted to the search for and study of extrasolar planetary systems. Only a small fraction of the NASA time (e.g., just 5 of the 28 successful NASA Keck proposals in the first half of 2010) is typically available for use by the broad community of planetary scientists. NASA Keck time is critical for planetary objects that require high spatial resolution (e.g. Uranus, Neptune, Titan, and Io) and/or deep sensitivity (e.g. Pluto and Kuiper Belt Objects). At present, Keck is the only facility that can provide diffraction-limited adaptive optics imaging on Uranus and Neptune.

Goldstone, Arecibo, and the VLBA

Two existing facilities, the Goldstone Solar System Radar (part of NASA's Deep Space Network) and the Arecibo Observatory, are critically important for radar studies of near-Earth objects (NEOs). The Arecibo Observatory, with its 305-m antenna and 900 kW transmitter (at 13 cm wavelength), is the most powerful research radar in the world. The Goldstone facility, with its greater steerability, provides twice the sky coverage and much longer tracking times than the Arecibo antenna. In addition to giving the highest achievable spatial resolution, radar observations offer the unique capability to refine NEO orbital characteristics (hence the probability of impact on Earth) to high precision; a single radar detection improves the instantaneous positional uncertainty by orders of magnitude in comparison with an orbit determined only by optical methods. The Goldstone and Arecibo radars have also made important observations of Mercury, Venus, the Moon, Mars, the satellites of Jupiter, and the satellites and rings of Saturn.

The Very Long Baseline Array (VLBA) is a network of radio telescopes spread from Hawaii to the Virgin Islands and operated by the National Radio Astronomy Observatory. The VLBA is able to determine spacecraft positions to high accuracy, which allows refinement of planetary ephemerides. It also has assisted in tracking probe release and descent (Cassini's Huygens probe is an example).

Ground-based facilities that receive NASA support, including the Infrared Telescope Facility, the Keck Observatory, Goldstone, Arecibo, and the Very Long Baseline Array, all make important and in some cases unique contributions to planetary science. NASA should continue to provide support for the planetary observations that take place at these facilities.

Suborbital Telescopes

Balloon- and rocket-borne telescopes offer a cost-effective means of studying distant planets and satellites at ultraviolet and infrared wavelengths inaccessible from the ground. Because of their modest costs and development times, they also provide training opportunities for would-be developers of future spacecraft instruments.¹¹ NASA's Science Mission Directorate regularly flies balloon missions into the stratosphere, and carries payloads recommended by research and analysis programs. However, there are few funding opportunities to take advantage of this resource for planetary science, because typical planetary SRA awards are too small to support these missions. **A funding line to promote further use of these suborbital observing platforms for planetary observations would complement and reduce the load on the already over-subscribed planetary astronomy program.**

Stratospheric Observatory for Infrared Astronomy (SOFIA)

The Stratospheric Observatory for Infrared Astronomy (SOFIA) is a NASA facility consisting of a 2.7-m telescope mounted in a modified Boeing 747-SP aircraft that began science flights in mid-2010. Operations costs and observing time are shared by the United States (80 percent) and Germany (20 percent). Flying at altitudes up to 13.5 km, SOFIA observes from above more than 99 percent of the water vapor in the atmosphere, opening windows in the infrared spectrum that are unavailable to ground-based telescopes. SOFIA also provides opportunities for rapid response to time-dependent astronomical phenomena (e.g., comets and planetary impacts) and geography-dependent phenomena (e.g., stellar occultations). Solar system studies are one of the four primary science themes (together with star and planet formation, the interstellar medium, and galaxies and the galactic center) to which SOFIA's observing time is dedicated.¹²

Hubble Space Telescope

Hubble observations are crucial for research on the giant planets (especially Uranus and Neptune) and their satellites, and for planning future missions to these systems. Hubble's ultraviolet capability has been critical for studies of auroral activity on the gas giants, discovery of the atmospheres of Ganymede and Europa, and investigations of the plumes and atmosphere of Io. During the past decade, Hubble was also used to discover two additional moons (Nix and Hydra) around Pluto, and two additional moons (Cupid and Mab) and two new rings around Uranus. Hubble, although recently serviced, has a finite lifetime and will eventually be de-orbited, and no replacement space telescope with equivalent ultraviolet capability is currently planned.

James Webb Space Telescope

The James Webb Space Telescope (JWST) will be a 6.5-meter infrared-optimized telescope placed at Earth's L2 Lagrange point. It is currently scheduled for launch in 2014. JWST will provide unprecedented sensitivity and stability for near- and mid-infrared imaging and spectroscopy, especially at wavelengths blocked by Earth's atmosphere. JWST will contribute to planetary science in numerous ways, including diffraction-limited imaging (in the near infrared) of both large and small bodies difficult to match with existing ground-based facilities, spectroscopy of the deep atmospheres of Uranus and Neptune, planetary auroral studies with high spatial resolution, and observations of transient phenomena (storms and impact-generated events) in the atmospheres of the giant planets. JWST will overlap with several planetary missions, offering unique complementary and supplementary observations, and can extend studies of Titan beyond the 2017 end of the Cassini mission. The ability to track moving targets—a necessity for planetary observations—is currently being implemented. JWST's Science Working Group is planning many types of solar system observations, including imaging and spectra of Kuiper Belt objects and comets, as well as Uranus and Neptune and their satellites and ring systems. Work is currently being done to assess the feasibility of observations of the brighter planets such as Mars, Jupiter, and Saturn.

Near Earth Object Surveys

The discovery, characterization, and hazard mitigation of NEOs called for in the 2005 NASA Authorization Act are treated in a recent NRC study¹³ and are beyond the scope of this decadal survey. This section focuses on instrumentation and infrastructure needed for scientific surveys of NEOs.

Earth-based telescopic observations probe the shapes, sizes, mineral compositions, orbital and rotational attributes, and physical properties of NEOs. These data are used in defining the science goals and operational constraints for spacecraft missions to specific asteroids, and are critical for extrapolating what is learned from the very limited number of asteroid missions that will be possible to broader populations of small bodies. The Arecibo Observatory and the Goldstone facility are critical to refining NEO orbital and physical characteristics. New optical facilities, such as the Large Synoptic Survey Telescope (LSST) and Panoramic Survey Telescope and Rapid-Response System (Pan-STARRS), can dramatically increase scientific understanding of NEOs by expanding the catalog of known objects and their orbits, thus providing better population statistics and improved predictions for close passages by Earth.

Perhaps the greatest advance in characterizing NEOs will come from spacecraft missions that analyze them from orbit and/or return samples to Earth where sophisticated laboratory techniques can be brought to bear. The committee conducted a technology study of the accessibility of NEOs using solar electric propulsion (Chapter 4). With sufficient technology development such missions might

be conducted within the Discovery program, and there are intriguing possibilities for human missions to NEOs supported by NASA's Exploration Systems Mission Directorate (ESMD). Instruments (mapping cameras and spectrometers) for orbital characterization are already developed, but sampling instruments, especially for accessing the subsurface, require development.

The Deep Space Network

The Deep Space Network (DSN) is a critical element of NASA's solar system exploration program. It is the only asset available for communications with missions to the outer solar system, and is heavily subscribed by inner solar system missions as well. As instruments advance and larger data streams are expected over the coming decade, this capability must keep pace with the needs of the mission portfolio. In addition, future capabilities afforded by optical communication, transponder advances, advanced software, and other means may provide future increases in returned data volumes and will be important to meeting mission demands.

The DSN is composed of three stations located in Goldstone, California, Madrid, Spain and Canberra, Australia, along with operations control and other services in the United States. Each station has one 70-meter antenna, one 34-meter High Efficiency (HEF) antenna, and at least one 34-meter Beam Wave Guide (BWG) antenna. There is an additional BWG at Madrid and two more at Goldstone. These antennas support over three dozen missions with downlink and uplink capabilities in S-band, X-band and Ka-bands (limited). Collectively, these stations can provide nearly continuous full-sky coverage.

The 70-meter dishes are in high demand, particularly during critical events, because of their downlink capability, sensitivity, and ability to satisfy other mission requirements. As such, they are heavily oversubscribed, and present deep space missions are limited mostly by downlink rather than onboard storage. For example, the Cassini mission routinely must choose which data to play back, as the capacity of its solid state recorder exceeds what can be played back to Earth within allocated passes (Table 10.2). The DSN must also contend with aging infrastructure, particularly the 70-meter antennas which were constructed in the 1960s. Nonetheless, the DSN continues to perform extraordinarily well, returning data with a very low drop-out rate and achieving command and telemetry availabilities of better than 95 percent to most operating missions.

The DSN's current budget supports expansion of Ka-band downlink capability, and addition of two 34-meter BWGs at Canberra and one at Madrid by 2018. The longer-term configuration goal through the end of the decade includes plans for one more 34-meter BWG at each station by 2023 to nearly mimic the capability of a 70-meter antenna, while keeping the 70-meter antennas operational for as long as possible. In addition, there are plans for higher power spacecraft transmitters, development of a Universal Space Transponder, and increases in on-board data compression and selection coding techniques.

Future demands on the DSN will be substantial. There is an ever-growing need for downlink capacity. Sophisticated next-generation instruments can generate terabits of data, or more, in short time periods. With advances in, for example, LIDAR, synthetic aperture radar, and hyperspectral imaging, missions will require Ka-band, and higher, transmission rates to handle these data, even with improvements in on-board data processing.

Solar system exploration also requires either 70-meter antennas or equivalent arrays to achieve the sensitivity needed for distant outer solar system missions, such as to the inner Kuiper Belt. In addition, critical event monitoring and other operations of missions to closer bodies also require the high sensitivity and downlink margin of larger apertures.

The DSN must be able to receive data from more than one mission at one station simultaneously. If new arrays can only mimic the ability of one 70-meter station and nothing more, missions would still be downlink constrained and would have to compete against one another for limited downlink resources.

Although Ka-band downlink has a clear capacity advantage, there is a need to maintain multiple band downlink capability. For example, three-band telemetry during outer planet atmospheric occultations allows sounding of different pressure depths within the atmosphere. In addition, S-band is required for communications from Venus during probe, balloon, lander, and orbit insertion operations where other bands cannot penetrate the atmosphere. X-band capability is required for communication through the atmosphere of Titan, and also for emergency spacecraft communications. Finally, the DSN is crucial for precision spacecraft ranging and navigation, and this capability must be maintained.

TABLE 10.2 Typical Data Volumes (Gbit transmitted in an 8-hour pass) for Some Current and Future Planetary Missions Using Different DSN Antennas and Communication Bands

Antenna	Band	Max Data Rate (kbps) ^a	Typical data volume, Gbit/8-hour pass				
			MRO ^b	JEO ^c	Cassini ^d	Uranus ^e	New Horizons ^f at Pluto
34-m	<i>X</i>	8,400-8,500	115		1		0.001
	<i>Ka</i>	31,800-32,300	86^g	<i>4</i>		<i>0.2</i>	
70-m or array	<i>X</i>	8,400-8,500	173		4		0.003
	<i>Ka</i>	31,800-32,300	<i>800^h</i>	<i>18</i>		<i>0.9</i>	

^a Actual downlink rate depends on spacecraft transmitter power, High Gain Antenna size/gain, distance, DSN elevation, weather.

^b MRO has 35W Ka and 100W X-band transmitters, 3-m High Gain Antenna, 160-Gb storage.

^c JEO assumes 25W X and Ka-band transmitters, 3-m High Gain Antenna, 17-Gb storage.

^d Cassini has 20W X-band transmitter, 3-m High Gain Antenna, 4-Gb storage.

^e Uranus Orbiter and Probe assumes 40W Ka-band transmitters, 2.5-m High Gain Antenna, 32-Gbit Storage.

^f New Horizons has 12W X-band transmitter, 2.1-m High Gain Antenna, 132-Gb storage.

^g Non-optimal test case.

^h Best case.

NOTE: Bold text denotes downlink-limited cases, and italic text denotes theoretical capability.

The committee recommends that all three DSN complexes should maintain high power uplink capability in X and Ka-band, and downlink capability in S, Ka, and X-bands. NASA should expand DSN capacities to meet the navigation and communication requirements of missions recommended by this decadal survey, with adequate margins.

Sample Curation and Laboratory Facilities

Planetary samples are arguably some of the most precious materials on Earth. Just as data returned from planetary spacecraft must be carefully archived and distributed to investigators, samples brought to Earth from space at great cost must be curated and kept uncontaminated and safe for continued study. Samples are a “gift that keeps on giving”, yielding discoveries long after they have been collected and returned. Even today, scientists are using new, state-of-the-art laboratory instruments to discover new things about lunar samples collected during the Apollo program four

decades ago. NASA rightly takes responsibility for the curation and distribution of planetary materials.

Collections of extraterrestrial materials are composed of:

- Samples that are delivered naturally to Earth in the form of meteorites and interplanetary dust particles, and
- Samples collected by spacecraft missions and returned to Earth for study.

Recent sample return missions include Genesis, which collected samples of the solar wind, and Stardust, which collected cometary material as it flew through the coma of Comet Wild 2. These missions continue a legacy of sample return that includes the robotic Luna and the human Apollo missions to the Moon. Currently, two sample return missions are under Phase-A study for NASA's New Frontiers program: OSIRIS-REx as a sample return mission to Near-Earth Asteroid 1999 RQ36, and MoonRise as a sample return mission to the South Pole-Aitken Basin region of the Moon. The missions recommended in Chapter 9 also include return of samples from a comet nucleus and Mars. In the next decade, then, requirements for sample curation will rapidly grow to become of highest priority.

Samples to be returned to Earth from many planetary bodies (e.g., the Moon, asteroids, and comets) are given a planetary protection designation of "Unrestricted Earth Return" as they are not regarded as posing any biohazard to Earth. However, future sample return missions from Mars and other targets that might potentially harbor life (e.g. Europa and Enceladus) are classified as "Restricted Earth Return" and are subject to quarantine restrictions, requiring special receiving and curation facilities that can preserve the pristine nature of the returned materials and prevent potential contamination of Earth. Such a Sample Receiving Facility (SRF) has been discussed in detail for Mars Sample Return,^{14,15,16} and would also need to be considered for return from other targets that are classified as Restricted Earth Return.

Consistent with past recommendations in the reports cited above, a SRF for Restricted Earth Return samples would provide the following:

- Biohazard assessment (following established protocols for life detection);
- Sterilization of samples for potential early release; and
- Release from containment of samples deemed to be safe, and transfer to appropriate curation facilities.

Current biohazard facilities focus predominantly on sample containment and so existing biocontainment facilities would not be optimal for receiving and characterizing the hazards associated with extraterrestrial materials. Nonetheless, it is a good policy, where appropriate, to use existing capabilities to reduce cost and risk, while maintaining the required safety requirements. A coordinated approach to all potentially hazardous returned samples is needed that leverages the considerable expertise within NASA and the scientific community in working with extraterrestrial samples. As plans move forward for Restricted Earth Return missions, including Mars sample return, **NASA should establish a single advisory group to provide input on all aspects of collection, containment, characterization and hazard assessment, and allocation of such samples. This advisory group must have an international component.**

The major site for curation and distribution of extraterrestrial samples within the United States is the Astromaterials Acquisition and Curation Office (AACO) of the Astromaterials Research and Exploration Science division at NASA's Johnson Space Center. The AACO oversees the preparation and allocation of samples for research and education, initial characterization of new samples, and secure preservation for the benefit of future generations. Sample allocation decisions are performed under the guidance of the Curation and Analysis Planning Team for Extraterrestrial Materials (CAPTEM) and the Meteorite Working Group (MWG), both supported through the Lunar

and Planetary Institute. Currently, the JSC's AACO has separate laboratories that support curation and distribution of Apollo lunar samples, Antarctic meteorites, Stardust cometary materials, Genesis solar wind samples, cosmic dust collected in upper atmosphere flights, and space-exposed hardware. Plans are in place for a new asteroid laboratory if OSIRIS-REx is selected as the next New Frontiers mission, and for expansion of the lunar laboratory if MoonRise is selected.

Sample curation facilities are critical components of any sample return mission, and must be designed specifically for the types of returned materials and handling requirements. Early planning and adequate funding are needed early in the mission cycle so that an adequate facility is available once samples are returned and deemed ready for curation and distribution. Particular challenges for the future include cryogenic handling of materials from comets, asteroids, the icy satellites, and the frigid depths of unlit craters on the Moon and Mercury, as well as biocontainment of samples from Mars and other targets of biological interest. **Every sample return mission flown by NASA should explicitly include in the estimate of its cost to the agency the full costs required for appropriate initial sample curation.** The cost estimates for sample return missions recommended in Chapter 9 of this report include these curation costs.

The most important instruments for any sample return mission are the ones in the laboratories on Earth. To derive the full scientific return from sample return missions, it is critical to maintain technical and instrumental capabilities for initial sample characterization, as well as foster expansion to encompass appropriate new analytical instrumentation as it becomes available and as different sample types are acquired. It is equally crucial for NASA to maintain technical and instrumental capability in the sample science community. The development of new laboratory instrumentation is just as important for sample return missions as is development of new spacecraft instruments for other planetary missions. **Well before planetary missions return samples, NASA should establish a well-coordinated and integrated program for development of the next generation of laboratory instruments to be used in sample characterization and analysis.**

SUPPORTING RESEARCH AND RELATED ACTIVITIES AT NSF

The National Science Foundation's principal support for planetary science is provided by the Division of Astronomical Sciences in the Directorate for Mathematical and Physical Sciences. The Astronomy and Astrophysics Research Grants (AAG) Program, for example, provides individual investigator and collaborative research grants for observational, theoretical, laboratory, and archival data studies in all areas of astronomy and astrophysics, including planetary astronomy. Planetary astronomy themes include planetary interiors, surfaces, and atmospheres, planetary satellites, comets and asteroids, trans-Neptune objects, the interplanetary medium, and the origin and evolution of the solar system. Typical awards are in the range \$95,000 to \$125,000 per year for a nominal 3-year period. The focus of the program is scientific merit with broad impact and the potential for transformative research. Planetary scientists can also be supported directly through various career programs. In short, NSF supports nearly all areas of planetary science except space missions, which it supports indirectly through laboratory research and archived data.

Further contributions to planetary science are realized through investigator grants in the Directorate for Geosciences, and by NSF support of major observatory facilities that are open to planetary scientists, Antarctic meteorite collection and curation, and the study of Antarctic geomorphic analogs to ancient Mars.

NSF grants and support for field activities are a very important source of support for a limited subset of planetary science activities in the U.S., and should continue.

NSF INSTRUMENTATION AND INFRASTRUCTURE

Ground-Based Astronomical Facilities

Importantly, the NSF is the largest federal funding agency for ground-based astronomy in the US, supporting five national observatories:

- The National Optical Astronomy Observatory,
- The Gemini Observatory,
- The National Astronomy and Ionosphere Center,
- The National Radio Astronomy Observatory, and
- The National Solar Observatory

These facilities are collectively known as the National Observatories.

National Optical Astronomy Observatory

The NOAO operates two 4-meter and other smaller telescopes at the Kitt Peak National Observatory in Arizona and the Cerro Tololo Inter-American Observatory in Chile. NOAO plays a valuable role within the optical-infrared astronomical system. It provides merit-based access to the telescopes directly under NOAO management, it administers the Telescope System Instrumentation Program (TSIP) (see below) and other merit-based funds for access to a broader range of apertures and instruments operated by other institutions, and it serves as a community advocate and facilitator for LSST (see below) and an eventual U.S. role in extremely large telescopes.

Gemini Observatory

The Gemini Observatory operates two 8-m optical telescopes, one in the southern and one in the northern hemisphere in an international partnership. These telescopes and their associated instrumentation, including adaptive optics and spectroscopy in the near- and mid-infrared, are very important for planetary studies. Gemini's diffraction-limited mid-infrared imaging capability is particularly so. The Gemini international partnership agreement is currently under renegotiation, and the United Kingdom, which holds a 25 percent stake, has announced its intent to withdraw from the consortium in 2012. This eventuality would provide a good opportunity for increasing the U.S. share of Gemini, and also presents an opportunity for restructuring the complex governance and management structure. The Gemini partnership might consider the advantages of stronger scientific coordination with NASA mission planning needs.

The National Astronomy and Ionosphere Center

NAIC operates the Arecibo Observatory in Puerto Rico. As noted in the preceding discussion of observatories that receive some NASA support, Arecibo is a unique and important radar facility that plays a particularly important role in NEO studies.

The National Radio Astronomy Observatory

NRAO operates the Very Large Array (VLA), the Very Long Baseline Array (VLBA), and

the Green Bank Telescope (GBT), and also supports the Atacama Large Millimeter Array (ALMA). In the microwave and submillimeter wavelength regions, the two ground-based facilities ALMA and the Expanded VLA are of great importance to future planetary exploration. When the VLA expansion is completed later in this decade it will produce high fidelity, wide-band imaging of the planets across the microwave spectrum. The VLA, with its full suite of X- and Ka-band receivers, also provides a back-up downlink location to the DSN—Cassini, for example, has recently been successfully tracked with the VLA at Ka-band. ALMA, expected to come online this next decade, will provide unprecedented imaging in the relatively unexplored wavelength region of 0.3 mm to 3.6 mm (84 GHz to 950 GHz). ALMA will also yield an angular resolution of 0.1" and brightness accuracies to 0.1 percent of the peak image brightness.

The National Solar Observatory

NSO operates telescopes on Kitt Peak and Sacramento Peak, New Mexico, and six worldwide Global Oscillations Network Group (GONG) stations. Understanding the Sun is critical to understanding its relationship to planetary atmospheres and surfaces. The recent astronomy decadal survey report provides a comprehensive discussion of current and planned solar facilities.¹⁷ The committee notes that national ground-based solar facilities will be transformed when the Advanced Technology Solar Telescope becomes operational in 2017. Solar ground-based observations from optical to radio wavelengths are increasingly complemented by extensive probing at optical and ultraviolet wavelengths from spacecraft like SOHO, TRACE, STEREO, and Solar Dynamics Observatory. Advances in solar physics over the next decade will likely expand in areas that directly involve solar effects on Earth and other planets. **The committee endorses and echoes the astronomy decadal survey report's recommendation that "the NSF should work with the solar, heliospheric, stellar, planetary, and geospace communities to determine the best route to an effective and balanced ground-based solar astronomy program that maintains multidisciplinary ties."**

Public-Private Partnerships

Many important advances in planetary research have come from access to private facilities such as the Keck, Magellan, and MMT observatories via NSF's Telescope System Instrumentation Program (TSIP). This program provides funding to develop new instruments that enhance the scientific capability of telescopes operated by private (non-federally funded) observatories, in exchange for public access to those facilities. For example, in 2007 Uranus Ring-Plane Crossing observational work was supported at Keck via NOAO/TSIP time. The highly successful NSF TSIP program should continue with full support. The development of instrumentation that addresses the needs of the planetary community, such as low mass and power, high spatial resolution and sensitivity, and mid-infrared capability, are particularly encouraged.

Conclusions

The committee supports the National Observatories' ongoing efforts to provide public access to its system of observational facilities, and encourage the National Observatories to recognize the synergy between ground-based observations and in situ planetary measurements, perhaps through coordinated observing campaigns on mission targets.

The ground-based observational facilities supported wholly or in part by NSF are

essential to planetary astronomical observations, both in support of active space missions and in studies independent of (or as follow up to) such missions. Their continued support is critical to the advancement of planetary science.

Large Synoptic Survey Telescope

One of the future NSF-funded facilities most important to planetary science is the Large Synoptic Survey Telescope (LSST), a 6.5m wide-field survey telescope that will image the entire sky visible from its observing site in Chile in six wavebands some 1000 times in a period of 10 years. LSST will discover many small bodies in the solar system, some of which will require follow-up observations for the study of their physical properties. Some of these bodies are likely to be attractive candidates for future spacecraft missions. The potential for finding new populations of small bodies that are presently unknown but which will further illuminate the dynamical history of the solar system is especially exciting. The LSST will play a potentially critical role in completing the George E. Brown survey of all near-Earth asteroids down to a diameter of 140 m (mandated by the Congress), especially in the absence of a space-based infrared survey telescope optimized for this purpose. The nominal schedule for the LSST calls for a two-year commissioning phase starting in mid-2016, and the beginning of the 10-year operational phase in mid-2018. **The committee encourages the timely completion of LSST, and stresses the importance of its contributions to planetary science, as well as astrophysics, once telescope operations begin.**

Extremely Large Telescopes

With apertures of 30 meters and larger, ELTs will play a significant future role in planetary science. Among the advantages of such telescopes is improved spatial resolution at mid-infrared and longer wavelengths where planetary observations are impaired by the diffraction limit; even 8- to 10-meter telescopes have difficulty with the small angular sizes of Uranus and Neptune. Observations using a 30-meter telescope could, for example, resolve thermal emission from Neptune with about the same resolution as the 3-meter IRTF can for Saturn at the same wavelength, and give compositional information on a large number of trans-Neptune objects. International efforts for ELT development are proceeding rapidly, with at least three such telescopes in planning stages: the Giant Magellan Telescope (GMT); the Thirty-Meter Telescope (TMT), and the European Extremely Large Telescope. **The committee does not provide specific guidance to NSF on this issue. It endorses the recommendations and support for these facilities made by the 2010 Astronomy Decadal Survey and encourages NSF to continue to invest in the development of ELTs, and to seek partnerships to ensure that at least one such facility comes to fruition with some public access. The committee believes that it is essential that the design of ELTs accommodate the requirements of planetary science to acquire and observe targets that are moving, extended, and/or bright, and that the needs of planetary mission planning be considered in awarding and scheduling public time for ELTs.** The earliest possible date NSF can seek approval from the National Science Board to provide partial support to either the GMT or TMT project is 2014.

Small Telescopes

Small telescopes are also very useful for some solar system problems; amateurs with their personal telescopes are playing an increasing role in laying groundwork for professionals. The 2009 and 2010 Jupiter impacts were discovered by amateurs who alerted the professional community, and within hours of each event, observatory telescopes around the world were being mobilized for follow-

up observations. Likewise, monitoring of Uranus and Neptune for anomalous cloud activity is solidly within the capabilities of amateurs. Amateurs play an increasing role in the study of asteroids, both through photometric monitoring and occultations, as well as observing fast-moving near-Earth objects for orbit determinations. NSF support for modest investments in small observing facilities, such as equipment or filter sets for modest telescopes operated on university campuses or by amateur astronomers, would enhance the current synergy with professionals.

Laboratory Studies and Facilities for Planetary Science

In order to maximize the scientific return from NSF-funded ground-based observations and NASA space missions alike, materials and processes must be studied in the laboratory. Planetary science intersects with many areas of astrophysics that receive NSF funding for laboratory investigations. Although laboratory research costs a fraction of missions, in most areas it receives insufficient support, with the result that existing infrastructure is often not state of the art and required upgrades cannot be made. NSF can make a huge impact on planetary science by supporting this vital area of research. **The committee recommends expansion of NSF funding for the support of planetary science in existing laboratories, and the establishment of new laboratories as needs develop.** Areas of high priority for support include the following:

- Development and maintenance of spectral reference libraries for atmospheric and surface composition studies, extending from X-ray to mm wavelengths. Studies should specifically include ices and organics and their modification through bombardment by charged particles typical of planetary magnetospheres, as well as the interfaces among atmospheric, surface, and subsurface phases.
- Laboratory measurements of thermophysical properties of materials over the range of conditions relevant to planetary objects, including phase diagrams in high pressure and low temperature regimes, equations of state relevant to the interiors of the giant planets, rheological properties, photochemistry and energy-dependent radiation chemistry.
- Investment in laboratory infrastructure and support for laboratory spectroscopy (experimental and theoretical), perhaps through a network of general user laboratory facilities.
- Investigations of the physics and chemistry of aerosols in planetary atmospheres through laboratory simulations.

The ties between planetary science and laboratory astrophysics will continue to strengthen and draw closer with the expanding exploration of exoplanets and the development of techniques to study their physical-chemical properties.

NOTES AND REFERENCES

1. National Research Council, *An Enabling Foundation for NASA's Space and Earth Science Missions*, The National Academies Press, Washington, D.C., 2010.
2. National Research Council, *An Enabling Foundation for NASA's Space and Earth Science Missions*, The National Academies Press, Washington, D.C., 2010.
3. White papers received by decadal survey: William B. McKinnon, Exploration Strategy for the Outer Planets 2013-2022: Goals and Priorities; Matthew S. Tiscareno, Rings Research in the Next Decade.
4. P.L. Read, T.E. Dowling, and G. Schubert. 2009. Saturn's rotation period from its atmospheric planetary-wave configuration. *Nature* 460:608-610.

PREPUBLICATION COPY—SUBJECT TO FURTHER EDITORIAL CORRECTION

5. A.R. Vasavada and A.P. Showman. 2005. Jovian atmospheric dynamics: An update after Galileo and Cassini. *Rep. Prog. Phys.* 68:1935-1996.
6. M.A. Morales, E. Schwegler, D. Ceperley, C. Pierleoni, S. Hamel, and K. Caspersen. 2009. Phase separation in hydrogen-helium mixtures at Mbar pressures. *Proceedings of the National Academy of Sciences* 106:1324.
7. See, for example, J. Schmidt, K. Ohtsuki, N. Rappaport, H. Salo, and F. Spahn. 2009. Dynamics of Saturn's dense rings. Pp. 413-458 in *Saturn from Cassini-Huygens* (M.K. Dougherty, L.W. Esposito, and S.M. Krimigis, eds.). Springer.
8. National Research Council, *Rising Above the Gathering Storm: Energizing and Employing America for a Brighter Economic Future*, The National Academies Press, Washington, D.C., 2007.
9. National Research Council, *Rising Above the Gathering Storm, Revised: Rapidly Approaching Category 5*, The National Academies Press, Washington, D.C., 2010.
10. The most recent assessment of NASA's Education programs by the Office of Management and Budget was rated "moderately effective." Available at <http://www.whitehouse.gov/omb/expectmore/agency/026.html>.
11. For more details concerning NASA's suborbital program see, for example, National Research Council, *Revitalizing NASA's Suborbital Program: Advancing Science, Driving Innovation, and Developing a Workforce*, The National Academies Press, Washington, D.C., 2010.
12. NASA, *The Science Vision for the Stratospheric Observatory for Infrared Astronomy*, Ames Research Center, Moffett Field, California, 2009.
13. National Research Council, *Defending Planet Earth: Near-Earth Object Surveys and Hazard Mitigation Strategies*, The National Academies Press, Washington, D.C., 2010.
14. D.W. Beaty, C.C. Allen, D.S. Bass, K.L. Buxbaum, J.K. Campbell, D.J. Lindstrom, S.L. Miller, and D.A. Papanastassiou, Planning Considerations for a Mars Sample Receiving Facility: Summary and Interpretation of Three Design Studies, *Astrobiology* 9: 745-758, 2009.
15. National Research Council, *The Quarantine and Certification of Martian Samples*, National Academy Press, Washington, D.C., 2002.
16. National Research Council, *An Astrobiology Strategy for the Exploration of Mars*, The National Academies Press, Washington, D.C., 2007.
17. National Research Council, *New Worlds, New Horizons in Astronomy and Astrophysics*, The National Academies Press, Washington, D.C., 2010.

11

The Role of Technology Development in Planetary Exploration

The 50-year exploration of the solar system by robotic spacecraft not only has been one of the great adventures in history, but also has transformed humankind’s understanding of the collection of objects orbiting the Sun. Mission after mission, new, stunning discoveries have been made, each in its turn altering our view of the nature of the solar system. The scientific harvest from these robotic missions has been sensational, but the extraordinary breadth and depth of these discoveries would not have been possible without the parallel technology developments that provided the necessary capabilities.

Table 11.1 summarizes the key findings and recommendations from Chapters 4-8 that are related to technology development.

TABLE 11.1 Key Technology Findings and Recommendations from Chapters 4-8

	Chapter 4 The Primitive Bodies	Chapter 5 The Inner Planets	Chapter 6 Mars	Chapter 7 The Giant Planets	Chapter 8 Satellites
Technology Development	<p>Continue technology developments in several areas including ASRG and thruster packaging and lifetime, thermal protection systems, remote sampling and coring devices, methods of determining that a sample contains ices and organic matter and preserving it at low temperatures, and electric thrusters mated to advanced power systems.</p> <p>Develop a program to bridge the TRL 4-6 development gap for flight instruments.</p>	<p>Continue current initiatives.</p> <p>Possibly expand to include capabilities for surface access and survivability for Venus’s surface and frigid polar craters on the Moon.</p>	<p>Key technologies necessary to accomplish Mars Sample Return are: Mars ascent vehicle, rendezvous and capture of orbiting sample return container, and planetary protection technologies.</p>	<p>Continue developments in: ASRGs, thermal protection for atmospheric probes, aerocapture and/or nuclear-electric propulsion, and robust deep-space communications capabilities.</p>	<p>Develop technology necessary to enable Jupiter Europa Orbiter.</p> <p>Address technical readiness of orbital and in situ elements of Titan Saturn System Mission including balloon system, low mass/power instruments, and cryogenic surface sampling systems.</p>

TECHNOLOGY: PORTAL INTO THE SOLAR SYSTEM

Ongoing missions underscore the value of past technology investments. For example, Dawn's ion propulsion engine is the essential enabling component of its unique mission to investigate two of the largest asteroids. After a flight of nearly 4 years, Dawn will arrive at 4 Vesta to spend approximately a year, starting in the summer of 2011, making detailed observations of 4 Vesta, after which the spacecraft will cruise for another 3 years toward its second asteroid destination, 1 Ceres. At 1 Ceres in 2015-2016, Dawn will conduct another complete scientific investigation. Such a two-asteroid mission would not have been possible using classical chemical propulsion. Years ago, analytic studies showed that continuous thrust, high specific-impulse propulsion opened up many different mission opportunities, including missions with multiple targets. These studies triggered the technology development program that resulted in the ion engines that are currently propelling Dawn toward 4 Vesta.

The Mars Exploration Rovers, now in their seventh year conducting scientific observations while roaming the Red Planet, benefited immensely from significant precursor technological investments in both mobility systems and the scientific payload. The story is essentially the same for all pioneering robotic planetary missions: They would not have been possible, and would not have produced such extraordinary results, without the visionary technology developments that enabled or enhanced their capabilities.

Continued success of the NASA planetary exploration program depends upon two major elements. It is axiomatic that the sequence of flight projects must be carefully selected so that the highest priority questions in solar system science are addressed. But it is equally important that there be an ongoing, robust, stable technology development program that is aimed at the missions of the future, especially those missions that have great potential for discovery and are not within existing technology capabilities. Early investment in key technologies reduces the cost risk of complex projects, allowing them to be initiated with reduced uncertainty regarding their eventual total costs. Although the need for such a technology program seems obvious, in recent years investments in new planetary exploration technology have been sharply curtailed and monies originally allocated to it have been used to pay for flight project overruns. As already stressed in Chapter 9, it is vital to avoid such overruns, particularly in flagship projects.

In the truest sense, reallocating technology money to cover short-term financial problems is myopic. The long-term consequences of such a policy, if sustained, are almost certainly disastrous to future exploration. Metaphorically, reallocating technology money to cover tactical exigencies is tantamount to "eating the seed corn." **The committee unequivocally recommends that a substantial program of planetary exploration technology development should be reconstituted and carefully protected against all incursions that would deplete its resources. This program should be consistently funded at approximately 6-8 percent of the total NASA Planetary Science Division budget.** The technology program should be targeted toward the planetary missions that NASA intends to fly, and should be competed wherever possible. This reconstituted technology element should aggregate related but presently uncoordinated NASA technology activities that support planetary exploration, and their tasks should be reprioritized and rebalanced to ensure that they contribute to the mission and science goals expressed in this report. The remainder of this chapter will discuss the specific items that should be addressed by this reconstituted technology program.

From Laboratory to Spaceflight

Given an appropriate technology program budget, the way in which the monies are allocated to the different phases of technology development should be informed both by the lessons of past efforts at technology infusion, and by the guideline that any technology to be used on a flight mission should be at Technology Readiness Level 6 prior to the project's Preliminary Design Review. The technology readiness level (TRL) is a widely used reference system for measuring the development maturity of a

particular technology item. In general, low-TRL refers to technologies just beginning to be developed (TRL 1-3), and mid-TRL covers the phases (TRL 4-6) that take an identified technology to a maturity where it is ready to be applied to a flight project (Figure 11.1).

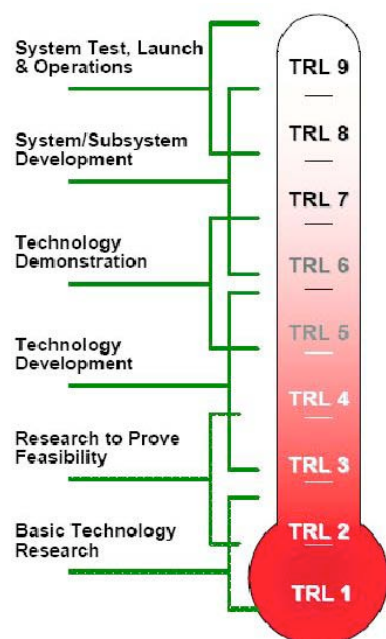

FIGURE 11.1 Technology Readiness Levels for space missions. SOURCE: NASA.

A primary deficiency in past NASA planetary exploration technology programs has been over-emphasis on TRLs 1-3 at the expense of the more costly but vital mid-level efforts necessary to bring the technology to flight readiness. Many important technological developments, therefore, have been abandoned, either permanently or temporarily, after they have reached TRL 3 or 4. This failure to continue to mature the technologies has resulted in a widespread “Mid-TRL Crisis” that has, in turn, created its own unique set of problems for flight projects. A new flight project that desires to use a specific technological capability must either complete the development itself, with the concomitant cost and schedule risk, or forgo the capability altogether. To properly complement the flight mission program, therefore, **the committee recommends that the Planetary Science Division’s technology program should accept the responsibility, and assign the required funds, to continue the development of the most important technology items through TRL 6.** Otherwise it will remain difficult, if not impossible, for flight projects to infuse these technologies without untoward cost and/or schedule risk.

Technology Infusion Initiatives

In recent competed mission solicitations, NASA provided incentives for infusion of new technological capabilities in the form of increases to the proposal cost cap. Specific technologies included as incentives were the following:

- Advanced solar electric propulsion, NASA’s Evolutionary Xenon Thruster (NEXT),
- Advanced bipropellant engines, the Advanced Material Bipropellant Rocket (AMBR),
- Aerocapture for orbiters and landers, and
- A new radioisotope power system, the Advanced Stirling Radioisotope Generator (ASRG).

These technologies continue to be of high value to a wide variety of solar system missions. **The committee recommends that NASA should continue to provide incentives for these technologies until they are demonstrated in flight. Moreover, this incentive paradigm should be expanded to include advanced solar power (especially lightweight solar arrays) and optical communications, both of which would be of major benefit for planetary exploration.**

The Need for Innovation

A significant concern with the current planetary exploration technology program is the apparent lack of innovation at the front end of the development pipeline. Truly innovative, breakthrough technologies appear to stand little chance of success in the competition for development money inside NASA, because, by their very nature, they are directed toward far-future objectives rather than specific near-term missions.

The committee's expectation is that the new NASA Office of the Chief Technologist formed in 2010 will reconstitute some kind of activity like the previous NASA Institute for Advanced Concepts (NIAC) that will elicit an outpouring of innovative technological ideas, and that those concepts will be carefully examined so that the most promising can receive continued support. However, it is not yet clear exactly how future technological responsibilities will be split between the new NASA technology office and the individual mission directorates. Given the unique needs of planetary science, **it is therefore essential that the Planetary Science Division develop its own balanced technology program**, including plans both to encourage innovation and resolve the existing Mid-TRL Crisis. These plans should be carefully coordinated with the NASA technology office to optimize their management and implementation.

TECHNOLOGY NEEDS

Core Multi-Mission Technologies

Although the ingenuity of the nation's scientists and engineers has made it appear almost routine, solar system exploration still represents one of the most audacious undertakings in human history. Any planetary spacecraft, regardless of its specific destination, must cope with the fundamental challenges of traveling long distances from the Earth and Sun, surviving and operating over the resulting long mission duration, and operating without real-time control from Earth and with limited data streams. These vehicles must be equipped to make a wide range of measurements while simultaneously dealing with the challenges of alien and frequently harsh environments. As future mission objectives evolve, meeting these challenges will require continued advances in several technology categories, including the following:

- Reduced mass and power requirements for spacecraft and their subsystems;
- Improved communications yielding higher data rates;
- Increased spacecraft autonomy;
- More efficient power and propulsion for all phases of the missions;
- More robust spacecraft for survival in extreme environments;
- New and improved sensors, instruments, and sampling systems; and of course
- Mission and trajectory design and optimization.

The Requirement for Power

Of all the multi-mission technologies that support future missions, none is more critical than high-efficiency power systems for use throughout the solar system. In particular, the committee notes the special significance of the new highly efficient ASRG, which enables up to 75 percent reduction in use of plutonium-238 compared to systems based on thermoelectric conversion. As discussed in Chapter 9, plutonium-238 is a limited and expensive resource for which production is currently at a standstill, and future production plans are uncertain. Since more efficient use of the limited plutonium supply will help to ensure a robust and ongoing planetary program, **the committee's highest priority for near-term multi-mission technology investment is for the completion and validation of the Advanced Stirling Radioisotope Generator**

Progress in these core technology areas will benefit virtually all planetary missions, regardless of their specific mission profile or destination. The robust Discovery and New Frontiers programs envisioned by this report would be substantially enhanced by such a commitment to multi-mission technologies. For the coming decade, **it is imperative that NASA expand its investment program in these fundamental technology areas with the twin goals of both reducing the cost of planetary missions and improving their scientific capability and reliability.** Furthermore, while the requirements will vary from mission to mission, the scope of these challenges requires careful planning so that research and development can establish the proper technological foundation. To accomplish this goal, **the committee recommends that NASA expand its program of regular future mission studies to identify as early as possible the technology drivers and common needs for likely future missions.**

Capability-Driven Technology Investments

In structuring its multi-mission technology investment programs it is important that NASA preserve its focus on fundamental system capabilities rather than solely on individual technology tasks. An example of such an integrated approach, which NASA is already pursuing, is the advancement of solar electric propulsion systems to enable a wide variety of new missions throughout the solar system. This integrated approach consists of linked investments in new thrusters, specifically the NEXT xenon thruster (Figure 11.2), plus new power processing, propellant feed system technology, and the systems engineering expertise that enables these elements to work together.

The committee recommends that NASA consider making equivalent systems investments in the advanced Ultraflex solar array technology that will provide higher power at greater efficiency, and aerocapture to enable efficient orbit insertion around bodies with atmospheres.

Investing in these system capabilities will yield a quantum leap in our ability to explore the planets and especially the outer solar system and small bodies. Perhaps more importantly, the availability of these systems is imperative in order for NASA to meet its solar system exploration objectives within reasonable budgetary constraints.

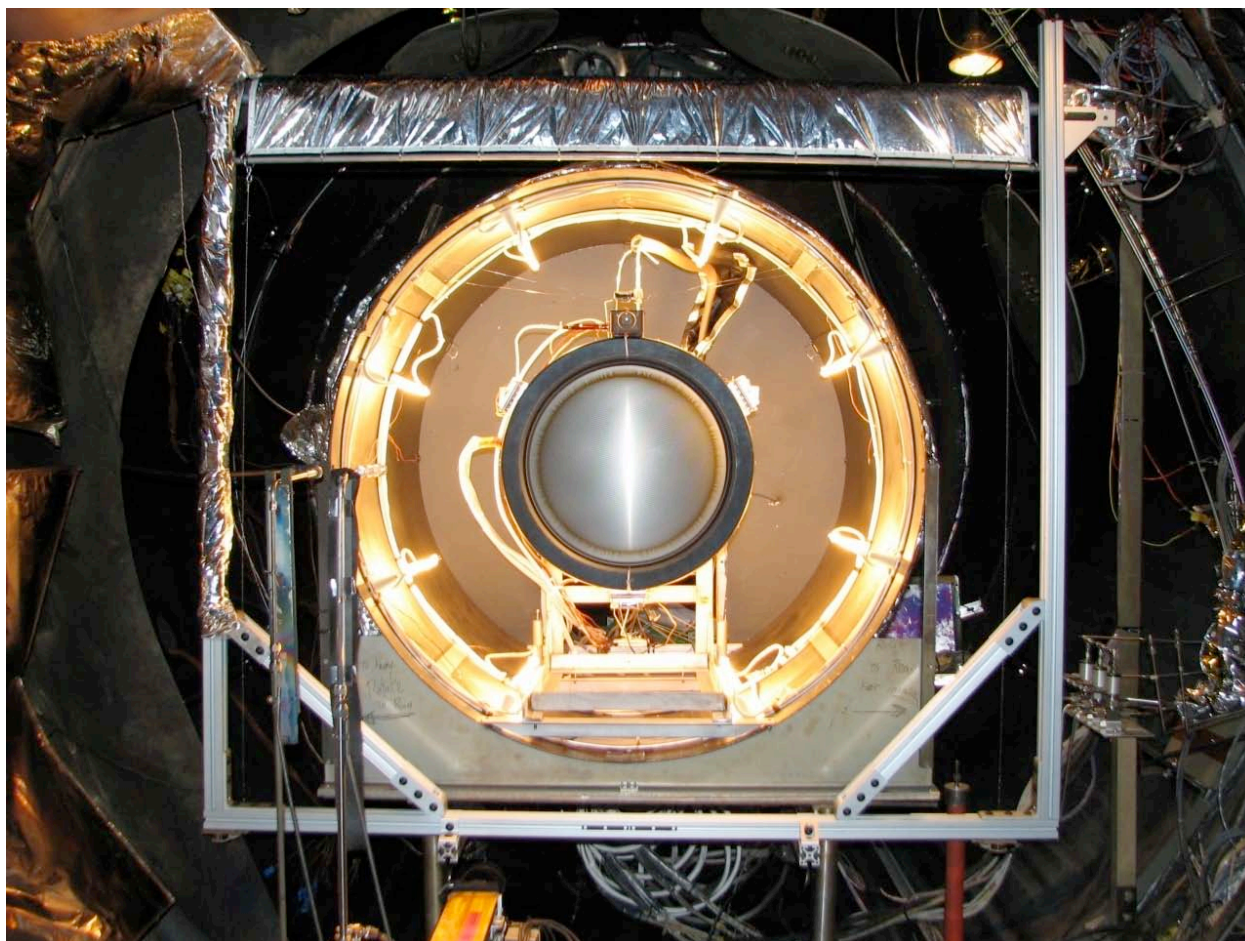

FIGURE 11.2 NEXT xenon thruster. SOURCE: NASA.

Planning for Competed Missions in the Next Decade

Solar system exploration in the coming decade will include many missions selected through open competition. Discovery and New Frontiers missions would benefit substantially from enhanced technology investments in the multi-mission technology areas described earlier; however, two issues have yet to be overcome:

- The nature of the peer review and selection process effectively precludes reliance on new and “unproven” technology, since it increases the perceived risk and cost of new missions; and
- It is difficult to ensure that proposers have the intimate knowledge of new technologies required to effectively incorporate them into their proposals.

Left unchecked, these two issues will ultimately limit the scope and ingenuity of competed missions.

While expanding its investments in generic multi-mission technologies, **NASA should encourage the intelligent use of new technologies in its competed missions. NASA should also put mechanisms in place to ensure that new capabilities are properly transferred to the scientific community for application to competed missions.** One example of such a transfer mechanism is the development of a freely available technology database, customized with the information required by new

proposals and populated by technologies that have been pre-screened by NASA to ensure that they can be infused with manageable risk. This database should be accompanied by publication of the results of technology development tasks in free and open media; plans for such publication should be made a prerequisite to the award of technology funding. In this manner NASA can ensure that its technology resources are used to the benefit of the entire community of potential mission proposers.

Technology for Flagship Missions in the Next Decade

NASA's comprehensive and costly flagship missions are strategic in nature, and have historically been assigned to NASA centers rather than competed. They can benefit from and in fact are enabled by strategic technology investments. The following sections provide a brief summary of the technological needs for the five flagship mission candidates discussed in Chapter 9.

Mars Astrobiology Explorer-Cacher

MAX-C is the first component of the Mars Sample Return campaign. For the MAX-C sample caching rover, the most challenging technology is sample acquisition, processing, and encapsulation on Mars. For the later elements in the Mars Sample Return campaign, the two greatest technological challenges are the Mars Ascent Vehicle (MAV), which will carry the samples from the martian surface to Mars orbit, and the end-to-end planetary protection and sample containment system. These three high priority technologies will each require major long-lead investments if the overall Mars Sample Return campaign is to have an acceptably high probability of success. The estimated required investment to bring the MAV up to TRL-6, for example, is around \$250 million. Additional technology developments may be required to enable precision landing by the MSR lander, and autonomous rendezvous and guidance for the MSR orbiter. **During the decade of 2013-2022, NASA should establish an aggressive, focused technology development and validation initiative to provide the capabilities required to complete the challenging MSR campaign.** Along with other required developments of infrastructure capabilities, such as sample handling facilities and Mars telecommunications, these developments will enable an intensive Mars exploration program leading to return of samples from the planet's surface.

Jupiter Europa Orbiter

The JEO mission will need to contend with the challenge of Jupiter's harsh radiation environment and the need to operate far from the Sun. Fortunately, since significant development has already been accomplished in many key technical areas, the JEO mission presently envisioned requires no fundamentally new technology in order to accomplish its objectives. However, the capability to design and package the science instruments, especially the detectors, so that they are able to acquire sufficiently meaningful data in the jovian radiation environment, has not yet been completely demonstrated. **A supporting instrument technology program aimed specifically at the issue of acquiring meaningful scientific data in a high radiation environment would be extremely valuable, both for JEO and for any other missions that will explore Jupiter and its moons in the future.** Planetary protection requirements will provide additional challenges for both the JEO spacecraft and its instruments.

Uranus Orbiter and Probe

The major technological challenges of this mission are:

- Long-lived, flight qualified ASRGs, with lifetimes in excess of 15 years;
- Lightweight materials for the orbiter structure and subsystems; and
- Thermal protection systems for the probe.

Although the Uranus mission can be accomplished using chemical propulsion, the availability of a flight-tested, comparatively inexpensive solar-electric propulsion module would result in both a wider range of launch dates and more mass in orbit around Uranus. Aerocapture capability would enhance a Uranus orbiter mission. For a Neptune orbiter, the advantages of aerocapture are enormous.

Enceladus Orbiter

The Enceladus Orbiter's key scientific instruments are a mass spectrometer, a thermal mapping radiometer, a dust analyzer, an imaging camera, and a magnetometer. Other than improvements in the sensitivity and accuracy of the mass spectrometer and thermal mapping radiometer in particular, which would enhance the scientific mission, the major technological challenge is ensuring reliability and lifetime of the ASRGs. The mission requires three ASRGs to deliver power throughout the Enceladus orbit phase, which lasts for at least a year beginning 12 years after launch. Because of the potential habitability of Enceladus, planetary protection is an additional technological challenge for an orbiter mission.

Venus Climate Mission

The Venus Climate Mission (VCM) includes four distinct flight elements: the carrier spacecraft that becomes a Venus orbiter, a gondola/balloon system, a mini-probe, and drop sondes. The packaging of the mini-probe and the drop sondes, especially integration of a sophisticated neutral mass spectrometer in the mini-probe, is the key technological challenge of VCM. Although each of the components of the entry flight system, which contains the gondola and the balloon, is close to TRL 6, indicating technological maturity, the entry flight system itself is still a significant design and development challenge. The management of the power, mass, and volume of this "Russian doll" vehicle throughout its design cycle could be viewed as a technology development in its own right.

Future Mission Capabilities: 2023-2032

During the coming decade, the missions recommended by this decadal survey will address the most compelling science objectives within the limited resources available to NASA. It is essential that the Planetary Science Division also invest in the technological capabilities that will enable missions in the following decade. During the course of this decadal survey, a number of mission concepts have been studied to assess their cost, feasibility, and scientific value, and these studies provide the foundation for important technology investments. Table 11.1 summarizes these missions and their key technology drivers. **The committee strongly recommends that NASA strive to achieve balance in its technology investment programs by addressing both the near-term missions cited specifically in this report, as well as the longer-term missions that will be studied and prioritized in the future.**

TABLE 11.1 Summary of Types of Missions That May Be Flown in the Years 2023-2033 and Their Potential Technology Requirements

Objective: 2023-2032	Mission Architecture	Key Capabilities
<i>Inner Planets</i>		
Venus climate history	<ul style="list-style-type: none"> • Atmospheric platform • Sample return 	<ul style="list-style-type: none"> • High-temperature survival • Atmospheric mobility • Advanced chemical propulsion • Sample handling
Venus/Mercury interior	Seismic networks	<ul style="list-style-type: none"> • Advanced chemical propulsion • Long duration high-temperature subsystems
Lunar volatile inventory	Dark crater rover	<ul style="list-style-type: none"> • Autonomy and mobility • Cryogenic sampling and instruments
<i>Mars</i>		
Habitability, geochemistry, and geologic evolution	Sample return	<ul style="list-style-type: none"> • Ascent propulsion • Autonomy, precision landing • In situ instruments • Planetary protection
<i>Giant Planets and their Satellites</i>		
Titan chemistry and evolution	Coordinated platforms: orbiter, surface and/or lake landers, balloon	<ul style="list-style-type: none"> • Atmospheric mobility • Remote sensing instruments • In situ instruments-cryogenic • Aerocapture
Uranus and Neptune/Triton	Orbiter, Probe	<ul style="list-style-type: none"> • Aerocapture • Advanced power/propulsion • High-performance telecom • Thermal protection/entry
<i>Primitive Bodies</i>		
Trojan and KBO composition	Rendezvous	Advanced power/propulsion
Comet/asteroid origin and evolution	<ul style="list-style-type: none"> • Sample return • Cryogenic sample return 	<ul style="list-style-type: none"> • Advanced thermal protection • Sampling systems • Verification of sample—ices, organics • Cryogenic sample preservation • Thermal Control during entry, descent, and landing

RECOMMENDED TECHNOLOGY INVESTMENTS

Science Instruments

The instruments carried by planetary missions provide the data to address key scientific questions and test scientific hypotheses. The wide variety of missions includes flybys, orbiters, atmospheric probes, landers, rovers, and sample returns. As would be expected, the range of science instruments that support these mission sets is also broad. At present there are significant technological needs across the entire range of instruments, including the improvement and/or adaptation of existing instruments and the development of completely new concepts.

Virtually all instruments can be improved by technological developments that reduce their mass and/or power and/or data transmission requirements. Increased instrument sensitivities and measurement accuracies dramatically expand the range of scientific hypotheses that can be addressed by a mission. Mass spectrometers are just one example of a family of instruments that would benefit significantly from a science instrument technology program aimed at improving basic instrument performance characteristics.

But improving and adapting existing instruments will not meet all the goals of future solar system missions. New concepts must also be supported and developed. Astrobiological exploration in particular is severely limited by a lack of flight ready instruments that can address key questions regarding past or present life elsewhere in the solar system. **The committee recommends that a broad-based, sustained program of science instrument technology development be undertaken, and that this development include new instrument concepts as well as improvements of existing instruments. This instrument technology program should include the funding of development through TRL-6 for those instruments with the highest potential for making new discoveries.**

Survival in Extreme Environments

One of the biggest challenges of solar system exploration is the tremendous variety of environments that spacecraft encounter. To explore the surface of Venus for any period longer than a few hours requires engineering systems and science instruments that can withstand intense heat and pressure. A spacecraft that dwells in the equatorial plane of Jupiter, or that orbits any of the inner Galilean satellites, must be designed to handle an extremely harsh radiation environment.

Systems or instruments designed for one planetary mission are rarely able to function properly in a different environment. Yet technological developments often are considered completed as soon as the specified technology demonstrates its functionality in a single environment. **The committee recommends that, as part of a balanced portfolio, a significant percentage of the Planetary Science Division technology funding be set aside for expanding the environmental applicability of existing engineering and science instrument capabilities.**

In Situ Exploration

Future missions will emphasize in situ exploration in a variety of environments. These will include such extremes as the atmospheres of the giant planets, the surfaces and atmospheres of Venus, Mars, and planetary satellites, and the surfaces and subsurfaces of small bodies. Exploration of such diverse environments requires a focused technology program element to prepare the required capabilities. Development of new and improved capabilities for entry and landing, mobility, sample acquisition and return, and planetary protection will help ensure progress toward the key objectives of the next and following decades.

Solar System Access and Other Core Technologies

The core multi-mission technologies described above provide the foundation for many of the missions that comprise the majority of planetary flight opportunities. It is essential that the Planetary Science Division continue to advance the state of the art in these technologies to benefit both the competed and flagship mission programs. In addition, flexibility to respond to new discoveries should be a hallmark of technology programs for the next decade. The allocation of technology monies for “discovery-driven” elements will ensure the ability to react quickly to the new needs and opportunities that are certain to emerge.

Research and development in the fields of celestial mechanics, trajectory optimization, and mission design have paid substantial dividends in the recent past, identifying new and higher performance opportunities for planetary missions. A future sustained effort in this technology area is essential, both to exploit fully the expanding range of possible mission modes (electric propulsion, aerocapture, etc.), and to continue to develop the automated software tools for searching rapidly for the “best” mission opportunities.

Summary

The future of solar system exploration depends on a well-conceived, robust, stable technology investment program. As recommended above, NASA’s Planetary Science Division should strive to set aside 6-8 percent of its mission budget for technology investments. It should also make certain that its technology program has a balanced portfolio, with significant investments in each of the key technology components. Table 11.2 presents an example of a technology investment profile that would have the appropriate balance.

TABLE 11.2 An Example of a Possible Technology Investment Profile That Would Be Appropriately Balanced for the Future Requirements for Solar System Exploration

Technology Element	Percentage Allocation	Key Capabilities
Science instruments	35	Environmental adaptation Radiation tolerance In situ sample analysis and age dating Planetary protection
Extreme environments	15	High temperature and pressure Radiation tolerance (subsystems) Cryogenic survival and mobility
In situ exploration	25	Sample acquisition and handling Descent and ascent propulsion systems Thermal protection for entry and descent Impactor and penetrator systems Precision landing Mobility on surfaces and in atmospheres Planetary protection
Solar system access and core technologies	25	Reduced spacecraft mass and power Improved interplanetary propulsion Low-power, high-rate communications Enhanced autonomy and computing Aerocapture Improved power sources Innovative mission and trajectory design

12

A Look to the Future

Although this report establishes priorities for planetary science for the next decade, some of the missions it describes will not be launched until the mid-to-late 2020s. Others—e.g., the Uranus Orbiter and Probe—will take many years to reach their destinations. The Mars Astrobiology Explorer-Cacher mission will set NASA on a path that will only be completed when future missions are sent to retrieve the samples from Mars in subsequent decades. The committee’s recommended technology development program will enable many missions both in the near and distant future. This report will therefore have a legacy that goes well beyond the current decade.

Events inevitably will occur in the coming decade that this study cannot foresee. New scientific discoveries will be made, reshaping priorities for subsequent decadal surveys. The technology program that this report recommends will enable a broad range of future missions, including ones that the committee has not considered in any detail. A look backward shows that things have changed since the last decadal survey, including significant changes to the political and budgetary environment in which NASA and NSF operate. The recommendations of this report have been made with the realization that future change is inevitable; the responses to this report must take into account the inevitability of change.

PREPARING FOR THE NEXT PLANETARY DECADAL SURVEY

Section 301(a) of the NASA Authorization Act of 2005 directed NASA to have “[t]he performance of each division in the Science directorate... reviewed and assessed by the National Academy of Sciences at 5-year intervals.” In 2006 NASA asked for an assessment of the agency’s Planetary Sciences Division.¹ The planetary exploration midterm assessment produced the report *Grading NASA’s Solar System Exploration Program: A Midterm Report* in 2008.²

The authorization act calling for these midterm assessments cited several reasons for conducting the midterms. The primary one was to evaluate the progress or lack of progress of the agency at meeting the goals of the decadal surveys. This information could be used to identify management or budget changes that might be necessary to improve responsiveness to the surveys.

It is possible that Congress will continue to call for midterm assessments of the decadal surveys. A midterm assessment could evaluate NASA’s accomplishments of the goals of the decadal survey to date, and assess the degree to which scientific knowledge and understanding has advanced since the decadal survey.

The long timescales of spacecraft missions make planning on a decadal timescale appropriate, and the effort required once every 10 years for the science community to produce a decadal survey is substantial. **If a midterm assessment is carried out, it must be carefully constructed to reinforce the decadal process, while still taking into account any new discoveries or other changes that have taken place.**

There are other things that NASA and the planetary science community can do to prepare for the next decadal survey. Two of the most important are as follows:

- *Monitoring the implementation of the survey*—Agency budgets wax and wane, new scientific discoveries are made, and new technologies come to the fore. Change, both good and bad, has an

influence on the planetary science agenda and will impact the implementation of the recommendations in this report. A decadal survey should not be blindly followed if external circumstances dictate that a change in strategy is needed. But, who decides if change warrants a deviation from a decadal plan? The potential candidates—internal agency advisory committees, community based “analysis groups,” and NRC committees—are not currently chartered to play such a role. A group specifically tasked to monitor and assess progress toward decadal goals is essential. Such a group should be able to provide the necessary strategic guidance needed to achieve the decadal science goals in a timely manner and consistent with the survey recommendations.

- *Mission studies*—This decadal survey commissioned numerous mission studies that were carried out over a relatively short period of time and then subjected to Cost and Technical Evaluations. A more effective method would be for NASA to sponsor studies for potential flagship and New Frontiers missions that capture the broadest possible science questions as well as reduce the time pressure on the decadal survey itself. **The committee therefore recommends that NASA sponsor community-driven, peer-reviewed mission studies in the years leading up to the next decadal survey, using a common template for the study reports.**

NOTE AND REFERENCE

1. In 2006 NASA also asked the National Research Council to conduct such an assessment for the agency’s Astrophysics Division. In 2007 NASA asked the NRC for an assessment of the agency’s Heliophysics Division. The NRC is currently discussing plans for an assessment of the Earth Sciences Division.

2. National Research Council, *Grading NASA’s Solar System Exploration Program: A Midterm Report*, The National Academies Press, Washington, D.C., 2008.

Appendixes

A
Letter of Request and Statement of Task

LETTER OF REQUEST

National Aeronautics and Space Administration

Headquarters
Washington, DC 20546-0001



DEC 05 2008

Reply to Attn of: Science Mission Directorate

Dr. Charles F. Kennel
Chair, Space Studies Board
National Research Council
500 5th Street, NW
Washington, DC 20001

Dear Dr. Kennel:

The National Research Council (NRC) decadal survey concept was born with a comprehensive survey for ground-based astronomy, published in 1964. Since that time, the practice of canvassing the scientific community for program planning guidance has been extended to other fields of study. Planetary science's first true decadal survey, entitled "New Frontiers in the Solar System: An Integrated Exploration Strategy," was issued in 2003. Impressive progress has been made in many areas of planetary science since then, including, for example, enhanced understanding of small and primitive bodies, of the geology and history of Mars, and of the diverse character of satellites of the gas giant planets. As a result of this progress and a number of important programmatic developments affecting NASA's science programs, and in cognizance of the National Science Foundation's (NSF) continuing interest in and support of planetary science research, NASA's Science Mission Directorate (SMD) would like to initiate a follow-on survey effort at this time. The enclosed Statement of Task outlines the scope and assumptions to be used in the development of this new survey.

I would like to request that the NRC submit a plan to NASA for development of the decadal study defined by the Statement of Task. Since we would like to be able to use the findings of the survey to inform development of the fiscal year 2013 budget, the results of the effort should be available to us by March 31, 2011. Once agreement with the NRC on the scope and cost for the proposed study has been achieved, the NASA Contracting Officer will issue a task order for implementation. Dr. Jim Green will be the technical point of contact for this effort and may be reached at (202) 358-1588 or james.l.green@nasa.gov.

Sincerely,

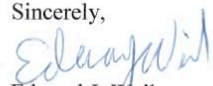
Edward J. Weiler
Associate Administrator for
Science Mission Directorate

PREPUBLICATION COPY—SUBJECT TO FURTHER EDITORIAL CORRECTION

A-1

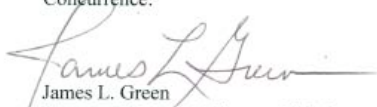
Congurrence:

James L. Green
Director, Planetary Sciences Division
Science Mission Directorate
National Aeronautics and Space
Administration

Craig B. Foltz
Acting Director
Division of Astronomical Sciences
National Science Foundation

STATEMENT OF TASK (Revised)

The Space Studies Board shall establish a Survey Committee (the “Committee”) to develop a comprehensive science and mission strategy for planetary science that updates and extends the Board’s current solar system exploration decadal survey, *New Frontiers in the Solar System: An Integrated Exploration Strategy* (2003).

The new decadal survey shall broadly canvas the field of space- and ground-based planetary science to determine the current state of knowledge and then identify the most important scientific questions expected to face the community during the interval 2013-2022. In addition, the survey and report shall address relevant programmatic and implementation issues of interest to NASA and the National Science Foundation (NSF). Since the content and structure of the program portfolios of the two agencies are distinct from one another, implementation and investment recommendations specific to each agency should be elaborated in separate sections of the final report. This will ensure that the report’s investment guidance will be clearly addressed to the appropriate agency, especially important in the current environment of elevated budget pressures.

It is critically important that the recommendations of the Committee be achievable within the boundaries of anticipated funding. NASA and NSF will provide an up-to-date understanding of these limitations to the Committee at the time of survey initiation. Recommendations of top-line funding increases for planetary science are not appropriate for this survey.

A. Science Survey and Recommendations

The scientific scope of the survey and report shall encompass the inner planets (Mercury, Venus, and Mars), the Earth’s Moon, major planets (Jupiter, Saturn, Uranus, and Neptune), the moons of the major planets, dwarf planets and small bodies, primitive bodies including comets and Kuiper Belt objects, and astrobology. The report should provide a clear exposition of the following:

1. An overview of planetary science—what it is, why it is a compelling undertaking, and the relationship between space- and ground-based planetary science research;
2. A broad survey of the current state of knowledge of the solar system; and
3. An inventory of the top-level scientific questions that should guide NASA flight mission investigations and supporting research programs and NSF’s programs that support planetary science research. The scientific questions for Mars and the Moon should be integrated with those pertaining to other solar system objects.

In order to ensure consistency with other advice developed by the NRC, specific guidelines for the scientific scope of the survey are as follows:

- With the exception of interactions with the atmospheres, magnetospheres, and surfaces of solar system bodies, which are within scope, solar and heliospheric phenomena are out of scope (these

PREPUBLICATION COPY—SUBJECT TO FURTHER EDITORIAL CORRECTION

A-2

latter topics are treated in the NRC report *The Sun to the Earth and Beyond—A Decadal Research Strategy in Solar and Space Physics* (2003) and its follow-on decadal survey; they will also be reviewed in the astronomy and astrophysics survey in concurrent development);

- Focused study of the Earth system, including its atmosphere, magnetosphere, surface, and interior, is out of scope (these topics are treated in the NRC report *Earth Science and Applications from Space—National Imperatives for the Next Decade and Beyond* (2007);
- Basic or supporting ground-based laboratory and theoretical research in astrobiology and areas like comparative planetology are within scope; but flight and ground investigations to detect and characterize exoplanets are out of scope (these topics are being addressed in the astronomy and astrophysics decadal survey in concurrent development).

B. National Science Foundation Recommendations

For NSF, the survey and report shall encompass all ground-based observational techniques, as well as analysis of data collected and relevant laboratory and theoretical investigations (including modeling and simulation). Thus, the study will assess the NSF-supported infrastructure of the field, including research and analysis support, the educational system, instrumentation and technology development, data distribution, analysis, and archiving, theory programs, and so on. The Committee shall also recommend any changes to this infrastructure that it deems necessary to advance the science and to capture the value of facilities in place.

The Committee shall review relevant programs of other nations and will comment on NSF opportunities for joint ventures and other forms of international cooperation.

C. National Aeronautics and Space Administration Recommendations

The NASA section of the report will reflect NASA's statutory responsibility for flight mission investigations. The principal components of the NASA implementation portion of the report shall include:

1. Recommendations on the optimum balance across the solar system and among small, medium, and large missions and supporting activities, the latter informed by the Space Studies Board's study on this topic ("mission-enabling activities") currently in progress;
2. Recommendations for individual flight investigations for initiation between 2013 and 2022 as follows:
 - i. Flight investigations believed executable for less than approximately \$450 million (candidates for the Discovery and Scout programs) should not be identified or prioritized. They will be proposed by community investigators to address the broad science goals in (A) above;
 - ii. Flight investigations with life cycle costs in the range \$450-900 million (New Frontiers class); the report should provide a candidate list of mission objectives, based on the 2008 Board report, *Opening New Frontiers in Space: Choices for the Next New Frontiers Announcement of Opportunity* (2008), as adjusted by the deliberations of the Committee;
 - iii. Specific destinations and science goals for "large" missions with life cycle costs projected to exceed \$900 million;
 - iv. The prioritization of flight investigations of Mars and the Moon should be integrated with flight investigation priorities for other solar system objects;
 - v. The findings and recommendations contained in *New Frontiers in the Solar System* and other recent and ongoing NRC reports on topics relevant to planetary science activities should be assessed and incorporated as appropriate. Missions identified in these reports that have not yet been confirmed for implementation must be reprioritized; and

vi. The flight investigations priority list should be supported by a summary of the assumptions underlying the relative rankings. This summary should, to the extent possible, be accompanied by decision rules that could guide NASA in adjusting the queue in the event of major unanticipated technical, cost, or other programmatic changes.

It is understood that initiation of missions on these lists will depend on actual resource availability.

3. Recommendations for NASA-funded supporting research required to maximize the science return from the flight mission investigations;

4. A discussion of strategic technology development needs and opportunities relevant to NASA planetary science programs; and

5. A discussion of (a) potential opportunities for conducting planetary science investigations involving humans in situ and (b) the relative value of human-tended investigations to those performed solely robotically. (NASA will provide before or at the time of survey initiation an update on NASA's human space flight plans.)

To provide NASA with actionable advice conforming to its portfolio boundaries, guidelines for the programmatic scope of recommendations to NASA are as follows:

- The scientific role of ground-based observations that support flight missions are within scope, but, except for operation of existing Goldstone facilities and the Infrared Telescope Facility (IRTF), recommendations regarding construction, operation, or funding of ground-based observatories are out of scope; and

- Scientific investigations of near-Earth objects (NEOs) are within scope, but approaches and mission concepts for space-based hazard mitigation are out of scope (they are the subject of a concurrent NRC study).

The Board should ensure that the study and report reflect an awareness of the science and space mission plans and priorities of potential foreign and U.S. agency partners and should identify opportunities for cooperation, as appropriate.

Study Approach

The flight and facilities programs recommended in the survey report must be executable within anticipated resources. In designing and pricing the study, the NRC should include resources for independent and expert cost analysis support to ensure that all flight mission cost estimates can be meaningfully intercompared and are as accurate as possible given the varying maturity of project concepts and other recognized uncertainties.

The final report must represent a comprehensive and authoritative analysis of the subject domain and a broad consensus among research community stakeholders. Therefore, NASA and NSF anticipate that the Committee will utilize specialized panels, with allocation of the domain of study among them to be determined by the Committee and the Board. It is important that the study activity include town hall meetings, sessions at geographically dispersed professional meetings, solicitation of white papers, and aggressive use of electronic communications for soliciting and aggregating inputs from across the community and country.

Products and Schedule

It is recommended that the Committee report consist of four products: a complete, integrative report of the findings and recommendations of the study; supporting reports of the focused panels, either included in the main report volume or in a separate volume; an abbreviated high level presentation of the

PREPUBLICATION COPY—SUBJECT TO FURTHER EDITORIAL CORRECTION

A-4

main findings and recommendations suitable for distribution to the general public; and a CD-ROM or DVD collection of all three components that can be easily and inexpensively disseminated.

In order to impact preparation of FY13 budget submissions, the major findings and prioritized recommendations of the survey should be submitted to NSF and NASA by March 31, 2011.

PREPUBLICATION COPY—SUBJECT TO FURTHER EDITORIAL CORRECTION

A-5

B

White Papers

One of the defining features of a decadal survey is broad community participation. One of the most important ways to ensure that the planetary science community played a major role in providing input to this report was the creation of a mechanism by which individuals and groups of individual researchers could submit white papers directly to the committee. White papers on all topics of relevance to the survey were strongly encouraged and the community was made aware of this via community newsletters, open letters to the community distributed using several relevant email explorers, and through personal solicitations during town hall meetings.

To facilitate document management, several submission guidelines were imposed. These included imposition of a seven-page limit (in a pre-specified format), transmission to the committee via a specific individual (the submitting author) through a special NRC website, and a submission deadline of 15 September, 2009, designed to ensure that all contributions were available for consideration and discussion no later than the second meetings of both the steering group and the five panels. Everyone in the planetary science community was encouraged to author white papers. However, members of the committee's steering group and the chairs of panels were discouraged from doing so on the grounds that they should appear to maintain a degree of impartiality.

In total, 199 white papers were received and are listed below alphabetically by their respective submitting author. Most, but not all, had multiple authors. Indeed, multiple authorship was specifically encouraged by the committee on the grounds that consensus is more compelling than a single viewpoint. To facilitate consensus and to advertize what white papers were in preparation, the Lunar and Planetary Institute established a web site where potential authors could state their intentions to draft a white paper on a specific topic and, thus, accrete coauthors. Some particular whitepapers attracted a hierarchy of authors, co-authors, supporters, and endorsers; sometimes running into the hundreds. The committee made no attempt to keep track of the identities and affiliations of those individuals whose only contribution to a particular document was to add their name to it. The committee was able to identify 1669 unique individuals as authors or co-authors of at least one white papers (Table B.1) For comparison, some 380 individuals contributed 24 white papers in support of the first planetary decadal process.

The energy, financial resources, and time devoted by the planetary community to this process is both gratifying to the committee and clear evidence of broad desire among the community to openly discuss and set priorities to guide our future activities related to the study of the solar system and planetary systems in general.

TABLE B.1 Institutional Distribution of the Authors and Co-authors of White Papers Contributed in Support of the Planetary Decadal Survey

Affiliation	United States	International	Total
Academia	494	167	661
Research and non-Profit Institutions	202	71	273
Jet Propulsion Laboratory	245	n/a	245
NASA Centers (excluding JPL)	234	n/a	234
Other U.S. Government Agencies	31	n/a	31
Foreign Government Agencies	n/a	98	98
Industry	93	6	99
Other/Not Specified/Unknown	27	1	28
Total	1326	343	1669

WHITE PAPERS CONTRIBUTED IN SUPPORT OF THE PLANETARY DECADAL SURVEY¹

Mian M. Abbas, Importance of Measurements of Charging Properties of Individual Submicron Size Lunar Dust Grains

Mian M. Abbas, Global Distributions of Gas & Dust in the Lunar Atmosphere from Solar Infrared Absorption Measurements with a Fourier Transform Spectrometer

Paul A. Abell, Scientific Investigation of Near-Earth Objects via the Orion Crew Exploration Vehicle

Paul A. Abell, Goals and Priorities for the Study of Centaurs and Trans-Neptunian Objects in the Next Decade

C. Agnor, The Exploration of Neptune and Triton

Charles Alcock, Whipple: Exploring the Solar System beyond Neptune Using a Survey for Occultations of Bright Stars

Mark Allen, Astrobiological Research Priorities for Titan

Ariel D. Anbar, Astrobiology Research Priorities for Mercury, Venus and the Moon

Robert F Arentz, NEO Survey: An Efficient Search for Near-Earth Objects by an IR Observatory in a Venus-like Orbit

James W. Ashley, The Scientific Rationale for Studying Meteorites found on other Worlds

Sami W. Asmar, Planetary Radio Science: Investigations of Interiors, Surfaces, Atmospheres, Rings and Environments

David H. Atkinson, Entry Probe Missions to the Giant Planets

Dana E. Beckman, SOFIA Planetary Science Vision

Jeffrey L. Bada, Seeking Signs of Life on Mars: In Situ Investigations as Prerequisites to Sample Return Missions

Kevin H. Baines, Venus Atmospheric Explorer New Frontiers Concept

Tibor Balint, Technologies for Future Venus Exploration

Olga Prieto-Ballesteros, Astrobiology in Europa and Jupiter System Mission (EJSM)

Bruce Banerdt, The Rationale for a Long-Lived Geophysical Network Mission To Mars

Patricia M. Beauchamp, Technologies for Outer Planet Missions: A Companion to the Outer Planet

¹ Only the lead author is listed.

Assessment Group (OPAG) Strategic Exploration White Paper
Reta Beebe, Data Management, Preservation and the Future of PDS
Lars Borg, A Consensus Vision for Mars Sample Return
Alan Boss, Astrobiology Research Priorities for Exoplanets
William F. Bottke, Exploring the Bombardment History of the Moon
Sarah E. Braden, Unexplored Areas of the Moon: Non-Mare Domes
Daniel Britt, Asteroids
Linda R. Brown, Laboratory Spectroscopy to Support Remote Sensing of Atmospheric Composition
Mark A. Bullcock, The Venus Science and Technology Definition Team Flagship Mission Study
Bonnie J. Buratti, The Small Satellites of the Solar System
Jack Burns, Science from the Moon: The NASA NLSI Lunar University Network for Astrophysics Research (LUNAR)
Bruce A. Campbell, Exploring the Shallow Subsurface of Mars with Imaging Radar: Scientific Promise and Technical Rationale
Julie C. Castillo-Rogez, Laboratory Studies in Support of Planetary Geophysics
Andrew Cheng, Binary and Multiple Systems
Vincent Chevrier, Laboratory measurements in Support of Present and Future Missions to Mars
Karla B. Clark, Europa Jupiter System Mission
Michael R. Collier, Global Imaging of Solar Wind-Planetary Body Interactions using Soft X-ray Cameras
Geoffrey C. Collins, Ganymede Science Questions and Future Exploration
Pamela G. Conrad, Geochronology and Mars Exploration
John F. Cooper, Space Weathering Impact on Solar System Surfaces and Mission Science
Athena Coustenis, Future In Situ Balloon Exploration of Titan's Atmosphere and Surface
William B.C. Crandall, A Decadal Shift: From Space Exploration Science to Space Utilization Science
Ian A. Crawford, The Scientific Rationale For Renewed Human Exploration of the Moon
Arlin Crotts, On Lunar volatiles and Their Importance to Resource Utilization and Lunar Science
Andrew Daga, Lunar and Martian Lava Tube Exploration as Part of an Overall Scientific Study
J.B. Dalton, Recommended Laboratory Studies in Support of Planetary Science
Andrew M. Davis, Development of Capabilities and Instrumentation for Curation and Analysis of Returned Samples
Charles D. Edwards, Jr., Relay Orbiters for Enhancing and Enabling Mars In Situ Exploration
Larry W. Esposito, Mission Concept: Venus in Situ Explorer (VISE)
Ashley Espy, Interplanetary Dust
Jack Farmer, Astrobiology Research and Technology Priorities for Mars
Bill Farrel, The Lunar Dust Exosphere: The Extreme Case of an Inner Planetary Atmosphere
Leigh N. Fletcher, Jupiter Atmospheric Science in the Next Decade
Jonathan J. Fortney, Planetary Formation and Evolution Revealed with Saturn Entry Probe
Friedmann Freund, Previously Overlooked/Ignored Electronic Charge Carriers in Rocks
Marc Fries, Extralunar Materials in Lunar Regolith
Ian Garrick-Bethell, Ensuring United States Competitiveness in the 21st Century Global Economy with a Long-Term Lunar Exploration Program
James, B. Garvin, Venus: Constraining Crustal Evolution from Orbit via High-Resolution Geophysical and Geological Reconnaissance
Barry Geldzahler, Future Plans for the Deep Space Network
Jon D. Giorgini, Radar Astrometry of Small Bodies: Detection, Characterization, Trajectory Prediction, and Hazard Assessment
John Grant, Future Mars Landing Site Selection Activities
Robert E. Grimm, Electromagnetic Sounding of Solid Planets and Satellites
David H. Grinspoon, Comparative Planetary Climate Studies
Eberhard Grun, In-Situ Mass Spectrometry of Atmosphereless Planetary Objects
William .M Grundy, Exploration Strategy for the Ice Dwarf Planets

PREPUBLICATION COPY—SUBJECT TO FURTHER EDITORIAL CORRECTION

B-3

M. Gudipati, Laboratory Studies for Planetary Sciences
Jasper S. Halekas, Determining the Origins of Lunar Remanent Crustal Magnetism
John A. Stansberry, KBO Science with Argo—A Voyage through the Outer Solar System
Candice J. Hansen, Neptune Science with Argo—A Voyage through the Outer Solar System
Candice J. Hansen, Triton Science with Argo—A Voyage through the Outer Solar System
Walter Harris, Solar System Suborbital research: A Vital Investment in Scientific Techniques, Technology and Investigators of Space Exploration in the 21st Century
Samad Hayati, Strategic Technology Development for Future Mars Missions
Michael Hecht, Next Steps in Mars Polar Science
Michael Hecht, The Microstructure of the Martian Surface
Charles A. Hibbitts, Stratospheric Balloon Missions for Planetary Science
Robert Hodyss, Recommended Laboratory Studies in Support of Planetary Science: Surface Chemistry of Icy Bodies
Mark Hofstadter, The Atmospheres of the Ice Giants, Uranus and Neptune
Mark Hofstadter, The Case for a Uranus Orbiter
Steven D. Howe, The Mars Hopper: Long Range Mobile Platform Powered by Martian In-Situ Resources
T.A. Hurford, The Case for an Enceladus New Frontiers Mission
Dana M. Hurley, Lunar Polar Volatiles and Associated Processes
Naoya Imae, Supporting the Sample Return from Mars
Bruce M. Jakosky, Are there Signs of Life on Mars? A Scientific Rationale for a Mars Sample-Return Campaign as the Next Step in Solar System Exploration
Jeffrey R. Johnson, Summary of the Mars Science Goals, Objectives, Investigations, and Priorities
Jeffrey R. Johnson, The Importance of a Planetary Cartography Program: Status and Recommendations for NASA 2013-2023
Bradley L. Jolliff, Constraining Solar System Impact History and Evolution of the Terrestrial Planets with Exploration of Samples from the Moon's South Pole-Aitken Basin
Thomas Jones, Strengthening U.S. Exploration Policy via Human Expeditions to Near-Earth Objects
Rhawn Joseph, Life on Earth Came from Other Planets: Summary
Rhawn Joseph, Life on Earth Came from Other Planets
Michael Kavaya, Mars Orbiting Pulsed Doppler Wind Lidar for Characterization of Wind and Dust
Robert M. Kelso, Proposal for a Lunar Exploration/Science Campaign: A Commercially-Leveraged, Science-focused, Lunar Exploration Program
Mohammed O. Khan, The Importance of Utilizing and Developing Radioisotope Electric Propulsion for Missions Beyond Saturn
Krishan K. Khurana, Lunar science with ARTEMIS: A Journey from the Moon's Exosphere to its Core
Georgiana Kramer, The Lunar Swirls
Kimberly R. Kuhlman, Tumbleweed: A New Paradigm for Surveying the Surface of Mars
E. Robert Kursinski, Dual Satellite Mars Climate and Chemistry Mission Concept
Dante S. Lauretta, Astrobiology Research Priorities for Primitive Asteroids
Samuel J. Lawrence, Sampling the Age Extremes of Lunar Volcanism
Lawrence G. Lemke, Heavier than Air Vehicles for Titan Exploration
Robert J. Lillis, Mars's Ancient Dynamo and Crustal Remanent Magnetism
Sanjay S. Limaye, Venus Atmosphere: Major Questions and Required Observations
Amy S. Lo, Secondary Payloads Using the LCROSS Architecture
David J. Loftus, Chemical Reactivity of Lunar Dust Relevant to Human Exploration of the Moon
Ralph D. Lorenz, The Case for a Titan Geophysical Network Mission
Jonathan I. Lunine, Saturn's Titan: A Strict Test for Life's Cosmic Ubiquity
Jonathan I. Lunine, The Science of Titan and its Future Exploration.
Edward R. Martinez, Thermal Protection System Sensors
Michael D. Max, Is a Resource-Mars a Stepping-Stone to Human Exploration of the Solar System?
William B. McKinnon, Exploration Strategy for the Outer Planets 2013-2022: Goals and Priorities

PREPUBLICATION COPY—SUBJECT TO FURTHER EDITORIAL CORRECTION

B-4

Stephen M. Merkowitz, The Moon as a Test Body for General Relativity
Scott Messenger, Sample Return from Primitive Asteroids and Comets
Richard S. Miller, Lunar Occultation Observer (LOCO): A Nuclear Astrophysics All-Sky Survey Mission
Concept using the Moon as a Platform for Science
Michael A. Mischna, Atmospheric Science Research Priorities for Mars
Yasunori Miura, Lunar Fluids from Carbon and Chlorine Contents of the Apollo Lunar Samples
Saumitra Mukherjee, Effect of Star-burst on Sun-Earth Environment
Scott L. Murchie, The Scientific Rationale for Robotic Exploration of Phobos and Deimos
John F. Mustard, Why Mars Remains a Compelling Target for Planetary Exploration
John F. Mustard, Seeking Signs of Life on a Terrestrial Planet: An Integrated Strategy for the Next
Decade of Mars Exploration
Clive R. Neal, The Rationale for Deployment of a Long-Lived Geophysical Network on the Moon
Clive R. Neal, Developing Sample Return Technology Using the Earth's Moon as a Testing Ground
Clive R. Neal, The Lunar Exploration Roadmap
Clive R. Neal, Why the Moon is Important for Solar System Science
Connor A. Nixon, Titan's Greenhouse Effect and Climate: Lessons from the Earth's Cooler Cousin
Robert J. Noble, New Opportunities for Outer Solar System Science using Radioisotope Electric
Propulsion
E.Z. Noe Dobrea, Near-Infrared Imaging Spectroscopy of the Surface of Mars at Meter-scales to Constrain
the Geological Origin of Hydrous Alteration Products, Identify Candidate Sites and Samples for
Future In-situ and Sample Return Missions, and Guide Rover Operations
Michael C. Nolan, Imaging of Near-Earth Asteroids
Michael C. Nolan, Near-Earth Objects
Julian Nott, Advanced Titan Balloon Design Concepts
Julian Nott, Titan's Unique Attraction: It is an Ideal Destination for Humans
Brian J. O'Brien, Indicative Basic Issues about Lunar Dust in the Lunar Environment
David Y. Oh, Single Launch Architecture for Potential Mars Sample Return Mission Using Electric
Propulsion
Glenn S. Orton, Earth-Based Observational Support for Spacecraft Exploration of Outer-Planet
Atmospheres
Glenn S. Orton, Saturn Atmospheric Science in the Next Decade
Robert T. Pappalardo, Science of the Europa Jupiter System Mission
Cynthia B. Phillips, Exploration of Europa
Carlé M. Pieters, The Scientific Context for the Exploration of the Moon
Kevin P. Hand, An Astrobiological Lens on Planetary System Science
Kevin P. Hand, Astrobiology Priorities for Planetary Science Flight Missions
Andrew Pohorille, Limits of Terrestrial Life in Space
Oleksandr Potashko, Atmosphere as Sign of Life
Lisa Pratt, Mars Astrobiology Explorer-Cacher (MAX-C): A Potential Rover Mission for 2018
Scot C.R. Rafkin, The Value of Landed Meteorological Investigations on Mars: The Next Advance for
Climate Science
Andreas Rathke, Testing for the Pioneer Anomaly on a Pluto Exploration Mission
Torsten Bondo, Preliminary Design of an Advanced Mission to Pluto
J. Edmund Riedel, A Survey of Technologies Necessary for the Next Decade of Small Body and Planetary
Exploration
Andrew S. Rivkin, The Case for Ceres: Report to the Planetary Science Decadal Survey Committee
Andrew S. Rivkin, The Trojan Asteroids: Keys to Many Locks
Thomas Ruedas, Seismological Investigations of Mars's Deep Interior
S.W. Ruff, Laboratory Studies in Support of Planetary Surface Composition Investigations
John D. Rummel, Planetary Protection for Planetary Science and Exploration
Erin L. Ryan, The TRACER mission: A Proposed Trojan and Centaur Flyby Mission

PREPUBLICATION COPY—SUBJECT TO FURTHER EDITORIAL CORRECTION

B-5

Scott A. Sandford, The Comet Coma Rendezvous Sample Return (CCRSR) Mission Concept—The Next Step Beyond Stardust

Robert Schingler, ROSI—Return on Science Investment: A System for Mission Evaluation Based on Maximizing Science

Harrison H. Schmitt, Observations Necessary for Useful Global Climate Models

Harrison H. Schmitt, Lunar Field Geological Exploration

Harrison H. Schmitt, Geopolitical Context of Lunar Exploration and Settlement

Harrison H. Schmitt, Lunar Helium-3 Fusion Resource Distribution

Harrison H. Schmitt, Lunar Pyroclastic Deposits and the Origin of the Moon

Dirk Schulze-Makuch, Astrobiology Research Priorities for the Outer Solar System

Susanne P. Schwenger, The Importance of (Noachian) Impact Craters as Windows to the Sub-surface and as Potential Hosts of Life

Amalie Sinclair, Lunar Light—Planetary Renewal—A Holistic Viewpoint

Mark Skidmore, Planetary Science & Astrobiology: Cold Habitats for Life in the Solar System

David E. Smith, A Budget Phasing Approach to Europa Jupiter System Mission Science

Michael D. Smith, Mars Trace Gas Mission: Scientific Goals and Measurement Objectives

Sue Smrekar, Venus Exploration Goals, Objectives, Investigations, and Priorities

George Sonneborn, Study of Planetary Systems and Solar System Objects with JWST

Linda J. Spilker, Cassini-Huygens Solstice Mission

Linda J. Spilker, Neptune Ring Science with Argo—A Voyage through the Outer Solar System

Andrew Steele, Astrobiology Sample Acquisition and Return

Douglas Stetson, Mars Exploration 2016-2032: Rationale and Principles for a Strategic Program

Nathan Strange, Astrodynamics Research and Analysis Funding

Tore Straume, Solar Radiation Output: Reading the Record of Lunar Rocks

James T. Struck, Some Anthropology of Humans in Space

James T. Struck, Nobel Prize in Chemistry and Physics Arbitrary—Could be Awarded to Almost Anyone Who Has Worked in the Fields

David R. Thompson, Onboard Science Data Analysis: Implications for Future Missions

Matthew S. Tiscareno, Rings Research in the Next Decade

Timothy N. Titus, Mars Polar Science for the Next Decade

Alan Tokunaga, The NASA Infrared Telescope Facility

Wesley A. Traub, Exoplanets and Solar System Exploration

Allan H. Treiman, Groundbreaking Sample Return from Mars: The Next Giant Leap in Understanding the Red Planet

Allan H. Treiman, Sample Return from Earth's Moon

Allan H. Treiman, Venus Geochemistry: Progress, Prospects, and Future Missions

Peter Tsou, A Case for LIFE, Enceladus Flyby Sample Return

Steve Vance, Icy Satellite Processes in the Solar System: A Plurality of Worlds

Ethiraj Venkatapathy, Thermal Protection System Technologies for Enabling Future Mars/Titan Science Missions

Ethiraj Venkatapathy, Thermal Protection System Technologies for Enabling Outer Planet Missions

Ethiraj Venkatapathy, Thermal Protection System Technologies for Enabling Future Sample Return Missions

Ethiraj Venkatapathy, Thermal Protection System Technologies for Enabling Future Venus Exploration

Janet Vertesi, Sociological Considerations for the Success of Planetary Exploration Missions

J. Hunter Waite, Jr., Titan Lake Probe

James D. Walker, Active Seismology of Asteroids through Impact and/or Blast Loading

Harold A. Weaver, Goals and Priorities for the Study of Comets in the Next Decade (2011-2020)

Anthony Wesley, Ground-Based Support for Solar-System Exploration: Continuous Coverage Visible Light Imaging of Solar System Objects from a Network of Ground-Based Observatories

David A. Williams, Future Io Exploration for 2013-2022 and Beyond, Part 1: Justification and Science

PREPUBLICATION COPY—SUBJECT TO FURTHER EDITORIAL CORRECTION

B-6

Objectives

David A. Williams, Future Io Exploration for 2013-2022 and Beyond, Part 2: Recommendations for Missions

James G. Williams, Lunar Science and Lunar Laser Ranging

Paul Withers, The Ionosphere of Mars and its Importance for Climate Evolution

Michael H. Wong, A Dedicated Space Observatory for Time-domain Solar System Science

Tsun-Yee Yan, Radiation Facts and Mitigation Strategies for the JEO Mission

Roger V. Yelle, Prebiotic Atmospheric Chemistry on Titan

Eliot F. Young, Balloon-Borne Telescopes for Planetary Science: Imaging and Photometry

PREPUBLICATION COPY—SUBJECT TO FURTHER EDITORIAL CORRECTION

B-7

C

Cost and Technical Evaluation of Priority Missions

BACKGROUND

Concerns have been voiced for some time about the accuracy of the mission cost estimates used in past decadal studies. A 2006 National Research Council (NRC) report concluded that “major missions in space and Earth science are being executed at costs well in excess of the costs estimated at the time when the missions were recommended in the National Research Council’s decadal surveys for their disciplines. Consequently, the orderly planning process that has served the space and Earth science communities well has been disrupted, and the balance among large, medium, and small missions has been difficult to maintain.”¹ In response to this concern, the report recommended that “NASA should undertake independent, systematic, and comprehensive evaluations of the cost-to-complete of each of its space and Earth science missions that are under development, for the purpose of determining the adequacy of budget and schedule.”²

An extended discussion of cost estimates and technology readiness of candidate missions took place during a subsequent NRC workshop concerning lessons learned from past decadal surveys. Workshop participants found that cost and technology readiness evaluations that were conducted independently of NASA estimates would add value to the surveys. They also suggested that uniform cost estimating methods should be used within a given survey to facilitate cost comparisons among initiatives.³

With this guidance in hand, NASA called for an independent evaluation of cost and technology readiness in the statements of task for the NRC assessment of the agency’s Beyond Einstein program.⁴ Finally, in an act codifying the decadal surveys, Congress mandated that the NRC “include independent estimates of the life cycle costs and technical readiness of missions assessed in the decadal survey wherever possible.”⁵ Therefore, the statements of task for the most recent astronomy decadal survey,⁶ this study (Appendix A), and the recently initiated heliophysics decadal survey all call for independent cost and technical evaluations of recommended initiatives.

THE CHALLENGE OF COST, SCHEDULE, AND TECHNICAL ESTIMATES

The mission concepts used in decadal surveys are typically in preliminary stages of development. In NASA parlance these are pre-Phase A concepts. Experience shows that the cost of a space mission is usually not well understood until it has completed its preliminary design review (PDR). Even then, unexpected mass, cost, and schedule growth can occur during the later phases of design and development. Further challenging costing is the fact that some pre-Phase A concepts are more mature than others because more resources have been devoted to their formulation. Accordingly, ensuring that a costing exercise is level and fair requires that the relative maturity of concepts be taken into account.

Several different types of cost/schedule/technical risk evaluations are used when discussing spacecraft missions. The best known are the so-called ICE (independent cost estimates) and NASA’s TMC (technical, management, and cost). Less well known is the CATE (cost, schedule, and technical evaluation). Each has its own strengths and weaknesses (Table C.1).

TABLE C.1 Similarities and Differences Between Three Different Approaches to Assessing the Technical, Cost and Risk Characteristics of Spacecraft Missions

	TMC	ICE	CATE
Used consistently to compare several concepts	Yes	No	Yes
Concept cost is evaluated with respect to	Cost Cap	Project Budget	Budget Wedge
Maturity of concept	Phase A-B	Phase B-D	Pre-Phase A
<i>Evaluation Process Includes:</i>			
Quantified schedule growth cost threat	No	Typically	Yes
Quantified design growth cost threat	No	No	Yes
Cost threat for increase in launch vehicle capability	No	No	Yes
Independent estimates for non-U.S. contributions	No	No	Yes
Reconciliation performed with project team	No	Yes	No
Technical and cost risk rating (low, medium, high)	Yes	No	Yes

ICEs are typically done late in the lifecycle of a project after it has matured. They often do not consider certain aspects of cost growth associated with design evolution in the earliest phases of a project. The objective of the CATE process is to perform a cost and technical risk analysis for a set of concepts that may have a broad range of maturity, and to assure that the analysis is consistent, fair, and informed by historical data. Typically, concepts evaluated via the CATE process are early in their lifecycle, and therefore are likely to undergo significant subsequent design changes. Historically, such changes have resulted in cost growth. Therefore, a robust process is required that fairly treats a concept of low maturity relative to one that has undergone several iterations and review. CATEs take into account several components of risk assessment (Table C-1).

Because the CATE is best suited to the comparative evaluation of a family of pre-Phase A concepts, it is the methodology used in this decadal survey.

OVERVIEW OF THE CATE PROCESS

The NRC engaged the services of the Aerospace Corporation to perform independent CATEs of mission concepts identified by the committee’s steering group during this study. Aerospace’s CATE team consisted of technical, cost and schedule experts.

The committee’s five panels identified a total of 24 missions (Appendix G) that could address key scientific questions within their respective purviews. To ensure that the mission concepts were sufficiently mature for subsequent evaluation by the CATE team, NASA commissioned technical studies at leading design centers, including the Jet Propulsion Laboratory, the Goddard Space Flight Center, the Applied Physics Laboratory, and Marshall Spaceflight Center. The committee’s steering group selected concepts to be studied from those recommended by the panels. One or more “science champions” drawn from the ranks of the panels was attached to each of the centers’ study team to ensure that the concepts remained true to the scientific and measurement objectives of their originating panel.

The design centers conducted two different types of studies: rapid mission architecture (RMA) studies and full mission studies. The RMAs were conducted for immature but promising concepts for which a broad array of mission types could be evaluated to choose the one most promising approach. The resulting “point design” could then be subjected to a full mission study along with more mature concepts. Not all missions receiving RMA studies were selected by the steering group for full mission studies. Nor

were all full mission studies selected for CATEs.

Prior to concepts being submitted to the CATE contractor, significant trades were conducted, led by panel science champions, to initially determine science value or science returned for an initial cost estimate as determined by NASA. It was understood that these numbers were rough orders of magnitude. In some cases, a down select between two planetary bodies was made (Uranus and Neptune as an example), and then more detailed work was performed prior to submission to the CATE contractor for evaluation. A key aspect of the CATE process is that there were multiple interactions between the committee and the CATE contractor. For at least four concepts, the CATE contractor was re-directed to consider alternative solutions as defined by the committee that would lower cost and risk, but maintain science return. This last step or iteration was considered confidential to the committee and it was deemed un-necessary for NASA to participate in these iterations based on the experience of the committee members and the experience and knowledge of the CATE contractor. Thus, the committee believes that an iterative process was followed to ensure a tighter correspondence between science priorities and prioritized missions.

The 13 most promising full mission studies were identified by the steering group and passed to the CATE team for detailed technical, cost, and schedule assessments. When follow-up was required, the CATE team worked with the appropriate science champion to request additional information. The members of the CATE team worked interactively to determine an initial assessment of technical risk and cost and schedule estimates for each of 13 priority missions. The CATE teams strived, to the greatest extent possible, to be consistent across all concepts presented. In particular, recognizing that the design center that studied the mission may not be the one that ultimately implements it, the CATE process made no assumptions about what would be the implementing organization.

Following an initial internal review within Aerospace to assure that the 13 assessments were mutually consistent, the results were presented to the committee. The committee provided feedback to the CATE team who, in turn, incorporated this feedback into revised technical, cost and schedule risk assessments.

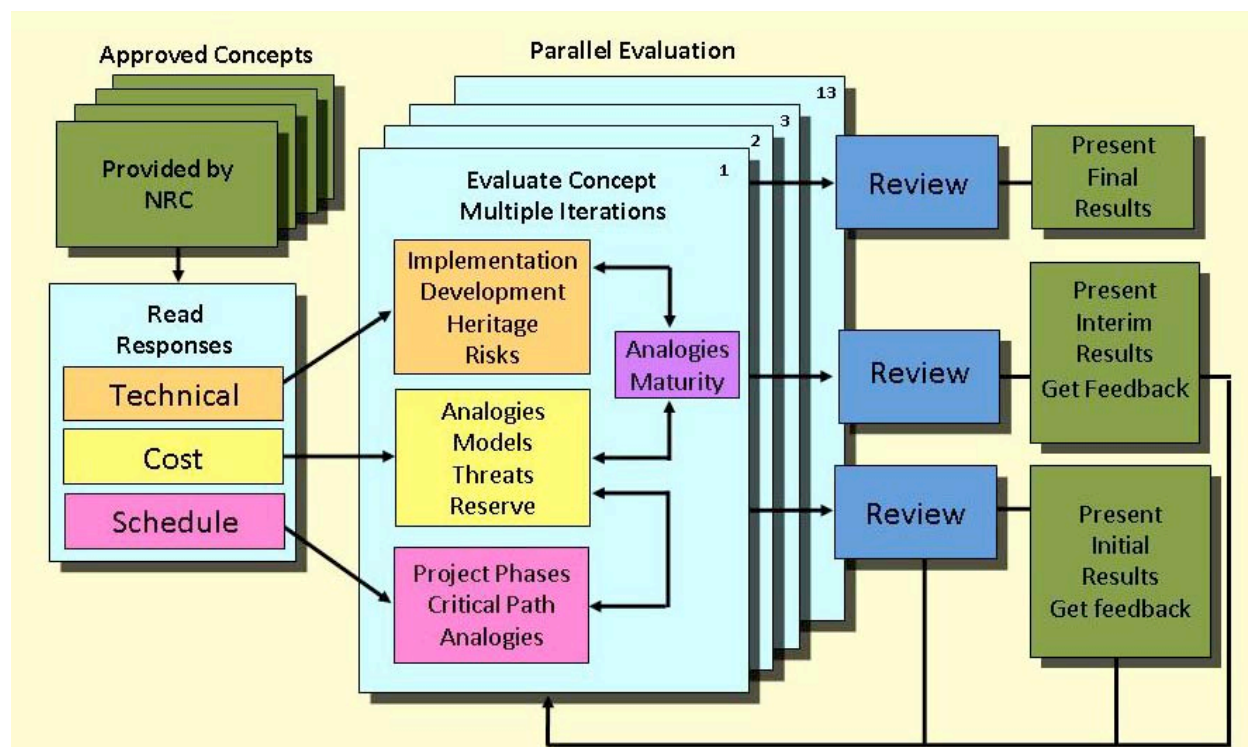

FIGURE C.1 Schematic illustration of the flow of the Aerospace Corporation’s cost and technical evaluation (CATE) process. The blocks in red indicate interaction by the CATE team with the committee.

The CATE team's approach (Figure C.1) is based on the following principles:

- Use multiple methods and databases regarding past space systems so that no one model or database biases the results. The CATE team used proprietary Aerospace models (e.g. Small Satellite Cost Model) and space-industry standards (e.g. the NASA/Air Force Cost Model (NAFCOM)).
- Use analogy based estimating; tie costs and schedule estimates to NASA systems that have already been built with known cost and schedule.
- Use both system level estimates as well as a build-up-to-system level by appropriately summing subsystem data so as not to underestimate system cost and complexity.
- Use cross checking tools, such as Complexity Based Risk Assessment (CoBRA) to cross check cost and schedule estimates for internal consistency and risk assessment.
- In an integrated fashion, quantify the total threats to costs from schedule growth, the costs of maturing technology, and the threat to costs owing to mass growth resulting in the need for a larger, more costly launch vehicle.

In summary, an analogy-based methodology ties the estimated costs of future systems to the known cost of systems that have previously been built. In other words, it provides an independent estimate of cost and complexity of new concepts anchored with respect to previously built hardware. The use of multiple methods such as analogies and standard cost models ensures that no one model or database biases the estimate. The use of system-level estimates and arriving at total estimated costs by statistically summing the costs of all individual Work Breakdown Structure (WBS) elements ensures that elements are not omitted and that the system-level complexity is properly represented in the cost estimate.

The assessments of technology, cost, and schedule are inextricably intertwined. However, it is easier to describe each element of the overall assessment (e.g., technical, schedule, and cost) separately noting in each instance the linkages to the overall CATE assessment.

Technical

The evaluation of technical risk and maturity in the CATE process focuses on the identification of the most important technical risks to achieving the required mission performance and stated science objectives. The assessment is limited to top-level technical maturity and risk discussions. Deviations from the current state of the art as well as system complexity, operational complexity, and integration concerns associated with the use of heritage components are identified. Technical maturity and the need for specific technology development are evaluated by the CATE technical team including readiness levels of key technologies and hardware. During the assessment of the technical risk areas and concept maturity, the technical team interacted with the cost and schedule teams so that technical risks could be translated into schedule and cost risk.

The CATE technical evaluation is limited to high level technical risks that potentially impact schedule and cost. The CATE process places no cost cap on mission concepts and hence risk as a function of cost is not considered. Concept maturity and technical risk are evaluated on the ability of a concept to meet performance within launch dates proposed with adequate mass, power and performance margins.

CATEs also evaluate proposed mass and power contingencies with respect to technical maturity. If the CATE technical team concludes that these contingencies are insufficient, the contingencies are increased based on historical data on mass and power growth. In some cases, growth in mass and power requirements necessitate the use of larger launch vehicles to execute the scientific mission. The assessments of required mass and power increases—and the potential needs for more capable launch vehicles—are provided to the CATE cost and schedule experts for incorporation into their estimates.

Schedule

To aid in the assessment of concept risk, independent schedule estimates are incorporated as part of the CATE cost estimate. This is especially true for assessment of risk with respect to proposed mission development and execution timelines. Like the CATE assessment of cost risk, schedule risk is also derived from analogies in the historical NASA record. Historical data from past analogous NASA missions, properly adjusted, are used to gauge the realism of the proposed durations of the development phases. Similarly, the time to critical mission reviews (e.g., PDR and CDR) and the time required for integration and testing are evaluated for each mission concept and contrasted with appropriate historical experience. Statistical analysis is utilized to create a schedule probability “S-curve”—i.e., a curve of the probability that a development time will exceed some value as a function of that value. The overall schedule, as proposed, is then adjusted with the historical data in mind. If the proposed schedule for a particular mission cannot be met, the next available launch window is selected. Costs incurred because original schedule cannot be met are then added to the total cost of the mission. The committee requested that the CATE team use the 70th percentile value in its schedule estimate—i.e., there is a 70 percent probability that the schedule will be shorter than indicated and a 30 percent probability that it will be longer. Complexity Based Risk Analysis (CoBRA) is used to develop a comparison of complexity versus cost relative to other missions.

Cost

The primary goal of the CATE cost assessment is to provide independent estimates (in FY 2015 dollars) that can be used to prioritize various concepts within the context of the expected NASA budgetary constraints for the coming decade (Appendix E). The CATE team developed high-level cost estimates based on the information provided by the various mission study teams with a focus on treating all projects equally. To be consistent for all concepts, the CATE cost process allows an increase in cost resulting from increased contingency mass and power, increased schedule, increased required launch vehicle capability, and other cost threats depending on the concept maturity and specific risk assessment of a particular concept.

All cost assessments for the CATE process are probabilistic in nature and are based on the NASA historical record and documented project lifecycle growth studies. Traditional S-curves of cost probability versus cost are provided for each concept with both the project estimate and the CATE estimate at the 70th percentile requested by the committee indicated.

The focus of the CATE costing process is to estimate the cost of conceptual hardware—e.g., instruments, spacecraft bus, landers—using multiple analogies and cost models based on historical data. A probabilistic cost-risk analysis is employed to estimate appropriate cost reserves. Ensuring consistency across the range of concepts—from those that are immature to those that are significantly more mature—the cost estimates are updated and adjusted with information from the technical CATE team with respect to mass and power contingencies, and potentially required additional launch vehicle capability. Using independent schedule estimates, costs are adjusted using appropriate “burn rates” to properly reflect the impact of schedule changes.

Finally, the results are integrated, cross-checked with other independent cost and schedule estimating capabilities and verified for consistency before being presented to the committee.

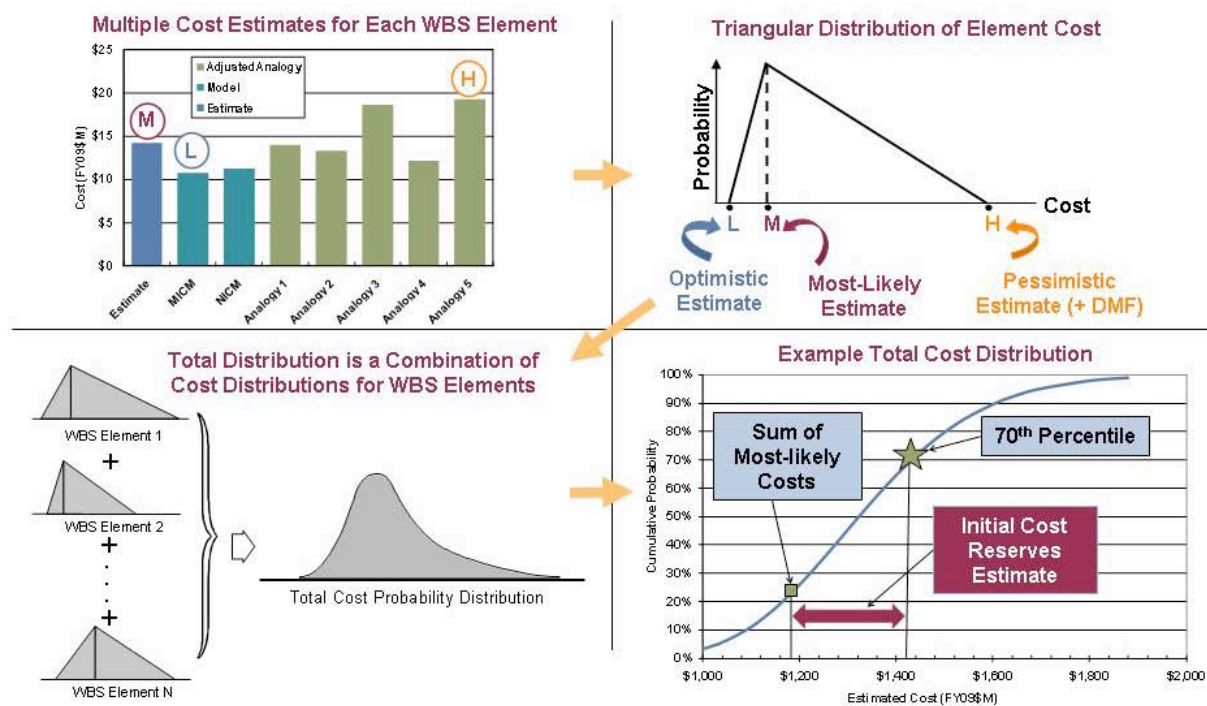

FIGURE C.2 Schematic illustration of the process of developing cost versus cumulative risk probability S-curve for a notional mission. The terms MICM and NICM in the upper left quadrant refer to NASA developed instrument cost models.

CoBRA COMPARISONS

The cost and schedule estimates for the committee’s priority missions are compared to historical experience by plotting cost and schedule as a function of the estimated complexity of the mission—resulting in a CoBRA (Complexity Based Risk Analysis) plot (Figure C.3). Such an analysis shows the locus of a notional mission compared to the historical experience of complexity versus cost for other missions. The expectation is that a proposed mission is on the road to success if the locus of the cost (and schedule) versus complexity point lies in the vicinity of the data for successful missions in the past.

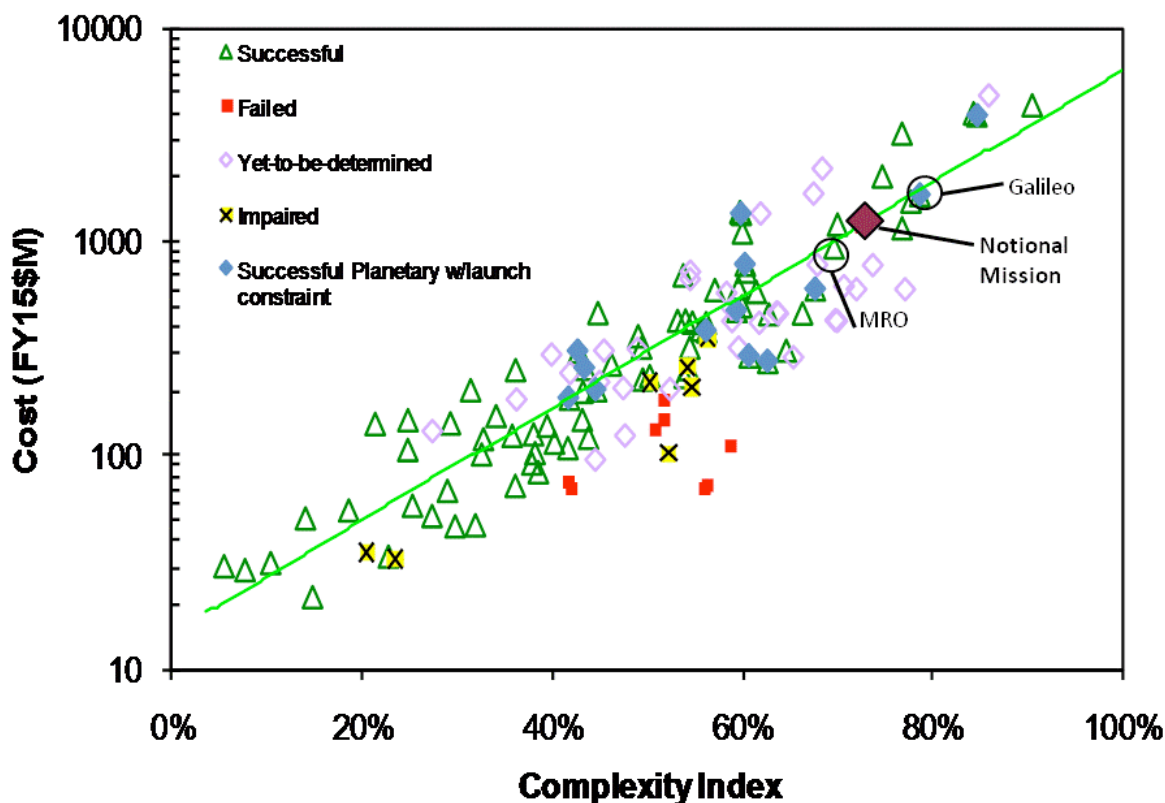

FIGURE C.3 Complexity Based Risk Assessment cost analysis superimposing the cost of a notional mission on historical data of cost versus complexity. A similar analysis can be performed plotting a schedule against complexity.

CATE RESULTS FOR PRIORITY MISSIONS

The missions analyzed via the Aerospace Corporation’s CATE methodology included the following (in approximate order of distance from the Sun):

- Venus Climate Mission
- Lunar Geophysical Network
- Mars Astrobiology Explorer-Cacher (plus descoped option)
- Mars Sample Return Orbiter⁷
- Mars Sample Return Lander⁸
- Io Observer
- Jupiter Europa Orbiter
- Trojan Tour
- Saturn Probe
- Titan Saturn System Mission
- Enceladus Orbiter
- Uranus Orbiter and Probe (with and without solar-electric propulsion stage)
- Comet Surface Sample Return

These missions were chosen by the committee based on their strong science return and their potential technical readiness.

Venus Climate Mission

Carrier Spacecraft and Entry Flight System

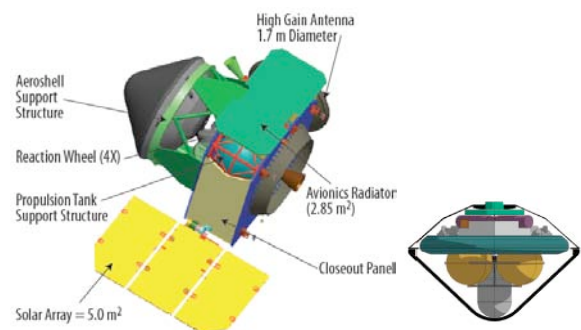

Carrier Spacecraft

Entry Flight System

SOURCE: NASA Mission Study (transmitted from George J. Tahu, NASA Planetary Science Division)

Key Challenges

- **Multiple Element Communications Architecture**
 - Critical Mini-Probe/Dropsonde science data is relayed through Gondola/Balloon to Carrier to Earth
 - Mini-Probe must communicate with Balloon/Gondola during inflation process
 - Challenge to predict Gondola/Balloon location for reacquisition
- **High Tempo Operations Near Venus Orbit Insertion (VOI)**
 - VOI is 2 hrs prior to Entry Flight System (EFS) entry
 - Mini-Probe is jettisoned minutes after EFS entry
- **Time Elapsed Since Heritage System Development**
 - Study uses Pioneer Venus and Galileo Probe as basis for several estimates
- **Potential for Carrier Spacecraft Instrument Growth**

Scientific Objectives

- **Examine the Venus atmosphere**
 - Improve understanding of the current state and evolution of the strong CO₂ greenhouse climate
- **Improve our ability to model climate and global change on Earth-like planets**
- **Key science themes:**
 - Characterize the CO₂ greenhouse atmosphere of Venus
 - Characterize the dynamics of Venus's superrotating atmosphere
 - Constrain surface/atmosphere chemical exchange
 - Determine origin of Venus's atmosphere
 - Understand implications for climate evolution of Earth

Key Cost Element Comparison

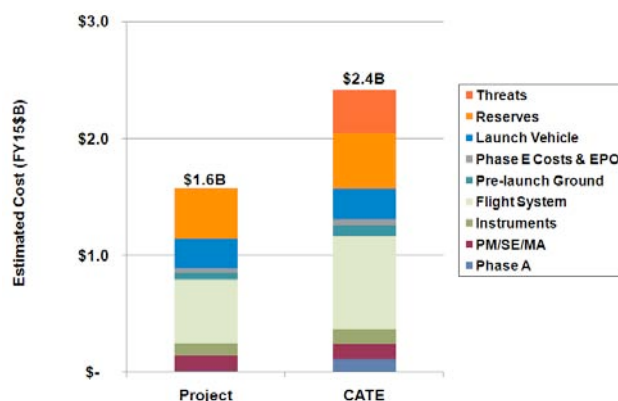

Key Parameters

- **Carrier Spacecraft**
 - Visible/Infrared Imager
- **Gondola/Balloon**
 - Atmospheric Structure Investigation, Nephelometer
 - Neutral Mass Spectrometer
 - Tunable Laser Spectrometer
 - Net Flux Radiometer
- **Mini-Probe (one) and Dropsondes (two)**
 - Atmospheric Structure Investigation (All)
 - Net Flux Radiometer (All)
 - Neutral Mass Spectrometer (Mini-Probe only)
- **5 m² gimbaled solar array on carrier spacecraft**
- **Launch Mass: 3984 kg**

Cost Risk Analysis S-Curve

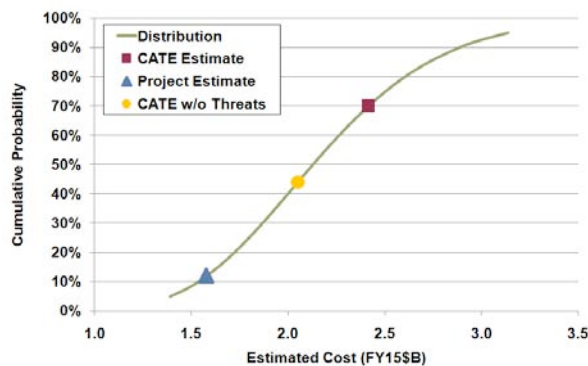

Lunar Geophysical Network

Lunar Lander Network—Four Landers

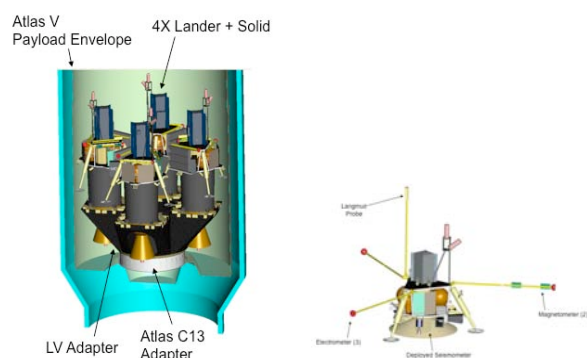

SOURCE: NASA Mission Study (transmitted from George J. Tahu, NASA Planetary Science Division)

Key Challenges

- **DACS Propulsion**
 - Development needed for MON-25/MMH combustion stability
- **Mass**
 - Low dry mass contingency for this development phase
 - Propulsion requirements multiply impact to overall mass growth
- **Reliability**
 - Single-string network reliability
- **Mission Operations**
 - High tempo operations for multi-lander cruise and landing phase

Scientific Objectives

- **Enhance knowledge of lunar interior**
- **Key science themes:**
 - Determine lateral variations in the structure and composition of the lunar crust, upper mantle, lower mantle, and lunar core
 - Determine distribution and origin of lunar seismic activity
 - Determine the lunar global heat flow budget to better constrain knowledge of lunar thermal evolution
 - Determine bulk lunar composition of radioactive heat-producing elements
 - Determine nature and origin of lunar crustal magnetic field

Key Cost Element Comparison

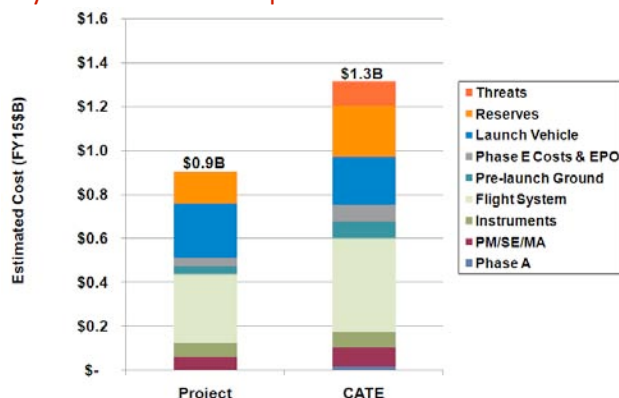

Key Parameters

- **Payload**
 - Seismometer
 - Heat Flow Experiment
 - Electromagnetic Sounder
 - Lunar Laser Ranging
 - Guest Payload
 - Education/Public Outreach Pancam
- **Advanced Stirling Radioisotope Generator Surface Power**
- **Launch Mass: 3572 kg (257 kg individual lander mass)**
- **Launch Date: 2016 (on Atlas V 511)**
- **Direct lunar near-side landing**

Cost Risk Analysis S-Curve

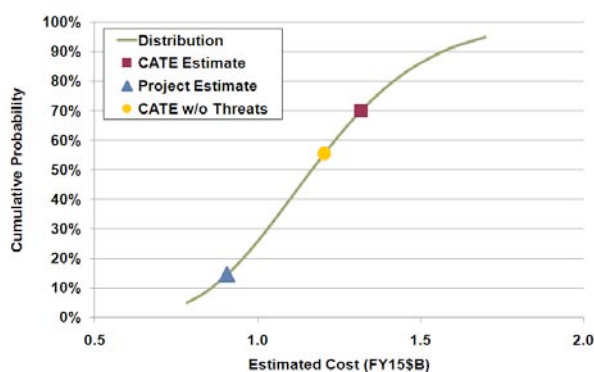

Mars Astrobiology Explorer-Cacher

Caching Mars Rover

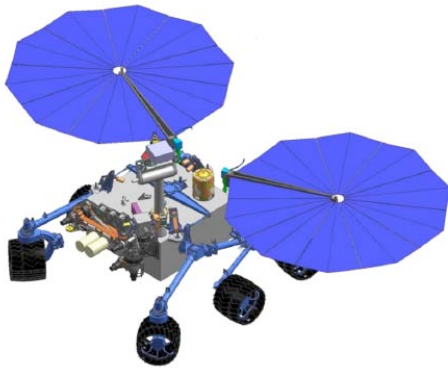

SOURCE: NASA Mission Study (transmitted from Lisa May, NASA Planetary Science Division)

Key Challenges

- **Vehicle Capabilities Beyond Mars Science Laboratory**
 - Terrain-relative descent navigation and precision landing with pallet
 - Aeroshell volume to accommodate MAX-C, ExoMars, and pallet
 - Increased rover traverse speed over MSL and MER
- **Sample Handling, Encapsulation, and Containerization (SHEC)**
 - Lack of maturity in SHEC subsystem
 - Affect of planetary protection and sample transfer requirements
- **Mass**
 - Insufficient mass growth contingency for this development phase
 - Low launch margin for this development phase

Scientific Objectives

- **Perform in situ science on Mars samples to look for evidence of ancient life or pre-biotic chemistry**
- **Collect, document, and package samples for future collection and return to Earth**
- **Key science themes:**
 - The search for extant life on Mars
 - The search for evidence of past life on Mars
 - Understanding martian climate history
 - Determination of the ages of geologic terrains on Mars
 - Understanding surface-atmosphere interactions on Mars
 - Understanding martian interior processes

Key Cost Element Comparison

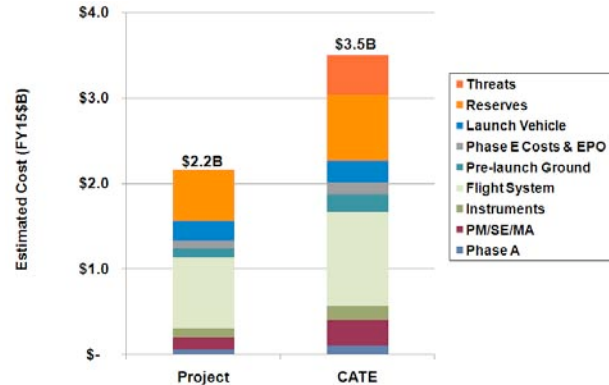

Key Parameters

- **Model Payload With Sampling/Caching System**
 - Pancam high resolution stereo imager (on mast)
 - Near-Infrared Point Spectrometer
 - Microscopic Imager
 - Alpha-Particle X-ray Spectrometer
 - Dual Wavelength Raman/Fluorescence Instrument
 - Sample Handling, Encapsulation, and Containerization (arm, corer/abrader, organic blank, handling and container system)
- **Two x 2.2 m diameter Ultraflex solar arrays**
- **Launch Mass: 4457 kg**
- **Launch Date: 2018 (on Atlas V 531)**
- **Orbit: Type I transfer direct to Mars surface**
 - 15° S to 25° N latitude

Cost Risk Analysis S-Curve

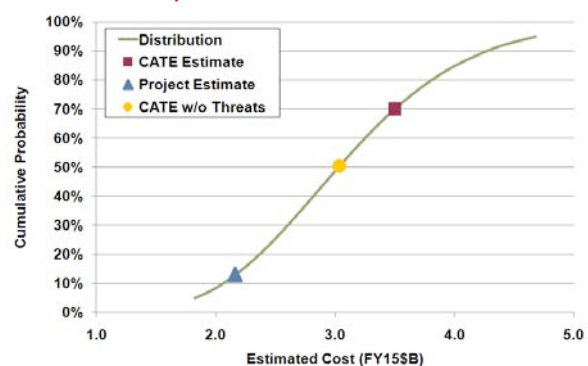

Mars Astrobiology Explorer-Cacher Descope

Caching Mars Rover

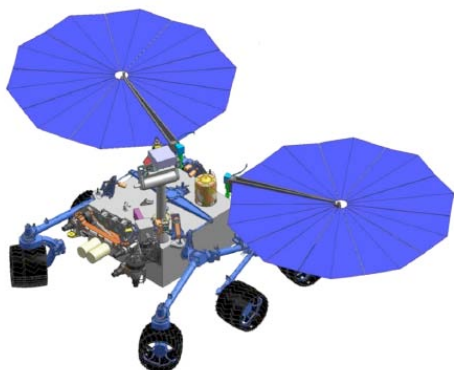

SOURCE: NASA Mission Study (transmitted from Lisa May, NASA Planetary Science Division)

Key Challenges

- **Keeping Within Mars Science Laboratory Design Constraints**
 - Potential need for modifying MSL skycrane to accommodate MAX-C rover
- **Sample Handling, Encapsulation, and Containerization (SHEC)**
 - Lack of maturity in SHEC subsystem
 - Affect of planetary protection and sample transfer requirements
- **Increased Rover Traverse Speed Over Mars Science Laboratory and Mars Exploration Rover**

Scientific Objectives

- Perform in situ science on Mars samples to look for evidence of ancient life or pre-biotic chemistry
- Collect, document, and package samples for future collection and return to Earth
- **Key science themes:**
 - The search for extant life on Mars
 - The search for evidence of past life on Mars
 - Understanding martian climate history
 - Determination of the ages of geologic terrains on Mars
 - Understanding surface-atmosphere interactions on Mars
 - Understanding martian interior processes

Key Cost Element Comparison

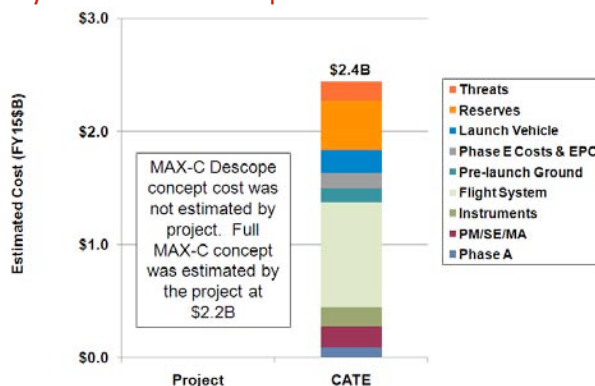

Key Parameters: Descope Concept

- **MAX-C rover identical to original proposed concept**
- **Mission identical, except:**
 - Launch Mass: 3421 kg
 - Launch Vehicle: Atlas V 521
- **Descope assumptions:**
 - No ESA ExoMars Rover
 - No landing pallet
 - Use of heritage Mars Science Laboratory entry and descent systems

Cost Risk Analysis S-Curve

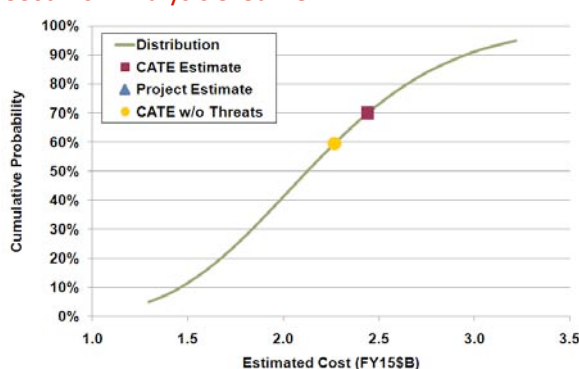

Mars Sample Return Orbiter and Earth Entry Vehicle

MSR Orbiter and Earth Entry Vehicle

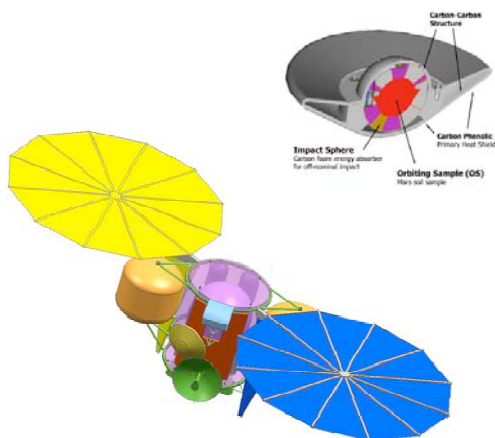

SOURCE: NASA Mission Study (transmitted from Lisa May, NASA Planetary Science Division)

Key Challenges

- **Sample Detection, Rendezvous, and Capture**
 - More autonomy required than Orbital Express mission
 - Minimal instrumentation for rendezvous and capture
- **Orbiter Instrument and Communications Package Growth**
 - Growth anticipated for onboard instrumentation
 - Low (10 kbps) telemetry rate unlikely to support instrument growth
- **Sample Transfer to EEV and Back Contamination**
 - Lack of definition for sample transfer and encapsulation
 - Planetary protection methodologies to prevent back contamination need further development
- **New Earth Entry Vehicle Design**
 - Very high reliability required for new EEV design
 - Heritage carbon phenolic manufacturing process needs to be rediscovered

Scientific Objectives

- Detect, rendezvous, and capture Orbiting Sample placed in orbit by Mars Ascent Vehicle
- Transfer the Orbiting Sample to an Earth Entry Vehicle (EEV)
- Return the EEV to Earth
- Provide a communications relay between Earth and the Mars Sample Return Lander
- Build Sample Processing Facility
- Key science themes:
 - None

Key Cost Element Comparison

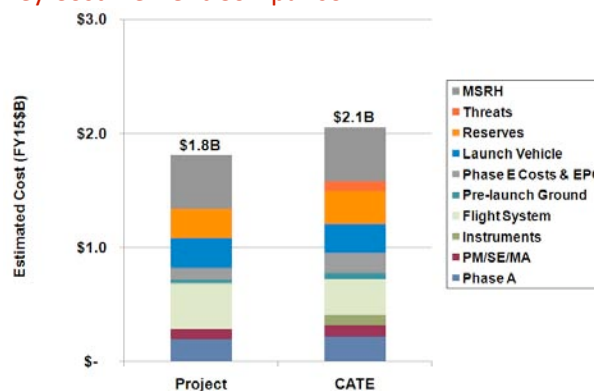

Key Parameters

- **Payload**
 - Optical Navigation Camera Assembly
 - Sample Capture and Transfer System
 - Earth Entry Vehicle
- One x 4.3 m Ultraflex solar array (1.25 kW @1AU Beginning of Life) plus one unpopulated 4.3 m panel for aerobraking
- Launch Mass: 3270 kg
- Launch Date: 2022 (on Atlas V 551)
- Orbit: 500 km circular Mars orbit (within ± 30 deg inclination) followed by sample retrieval and Earth return

Cost Risk Analysis S-Curve

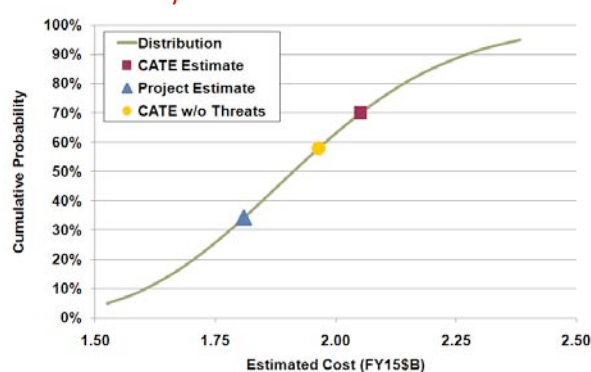

Mars Sample Return Lander and Mars Ascent Vehicle

MSR Lander, Mars Ascent Vehicle, and Fetch Rover

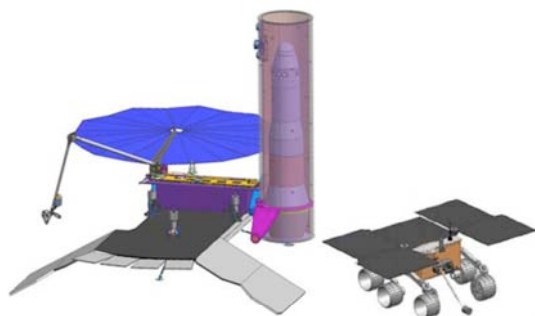

SOURCE: NASA Mission Study (transmitted from George J. Tahu, NASA Planetary Science Division)

Key Challenges

- **Sample Retrieval Speed**
 - Fetch Rover traverse speed, autonomy, and available power
 - Size of Mars Sample Return lander error ellipse
 - Mars Ascent Vehicle (MAV) life under thermal cycling conditions
- **Sampler Transfer**
 - Transfer of sample cache to MAV
 - Transfer of lander sample to MAV
- **Mars Ascent Vehicle Design Uncertainty**
 - Alternate concepts under consideration
- **Sample Collection and Packaging on Lander**
 - Lack of maturity of lander sample collection concept

Scientific Objectives

- Retrieve sample cache deposited on surface by Mars Astrobiology Explorer-Cacher rover
- Collect, document, and package regolith and atmosphere samples at the lander location
- Launch collected samples into Mars orbit for retrieval by the Mars Sample Return Orbiter
- Key science themes:
 - None

Key Cost Element Comparison

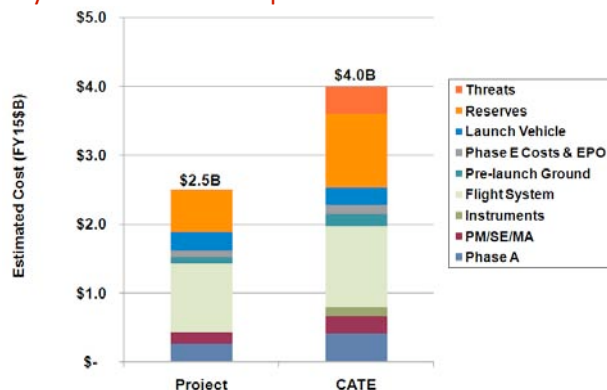

Key Parameters

- **Instrumentation:**
 - Lander: 3 lander cameras, 1 robotic arm camera, 1 sample insertion camera, 2 descent cameras
 - Fetch Rover: 4 navigation cameras, 4 hazard cameras
- One x 2.8 m diameter (6.2 m²) Ultraflex solar array on lander
- One x 2.7 m² Fetch Rover array
- Mars Ascent Vehicle: 300 kg, two-stage solid rocket
- Launch Mass: 4486 kg
- Launch Date: 2024 (on Atlas V 551)
- Orbit: Type I transfer direct to Mars surface
 - 15° S to 25° N latitude

Cost Risk Analysis S-Curve

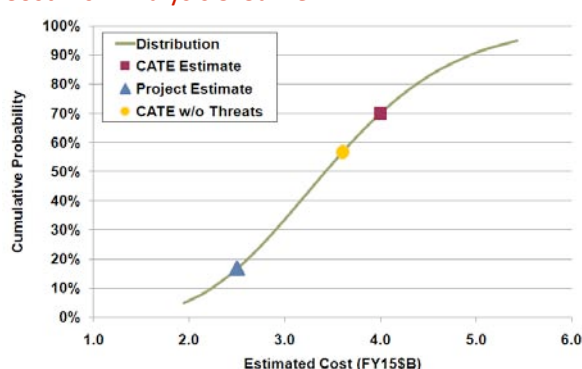

Io Observer

Io Observer Spacecraft



SOURCE: NASA Mission Study (transmitted from Curt Niebur, NASA SMD/Planetary Science Division)

Key Challenges

- **Radiation**
 - Electronics vault design
 - Radiation tolerant electronics and detectors
- **System Power**
 - Negative power margin when accounting for power growth contingency
 - Likely to require three ASRGs instead of two

Scientific Objectives

- **Determine internal structure of Io and mechanisms contributing to Io's volcanism**
- **Key science themes:**
 - Model volcanic processes on Io
 - Determine the state of Io's mantle
 - Model Io's tidal heating mechanisms
 - Model tectonic processes on Io
 - Understand interrelation between volcanic, atmospheric, plasma torus, and magnetospheric mass- and energy-exchange processes
 - Determine whether Io's core is generating a magnetic field
 - Characterize Io's surface composition
 - Improve our understanding of the Jupiter system

Key Cost Element Comparison

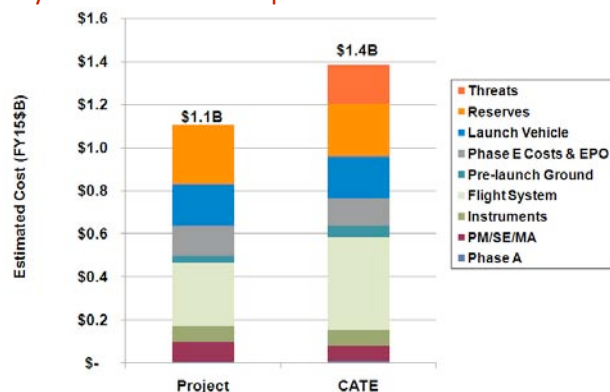

Key Parameters

- **Flight System Payload**
 - Narrow Angle Imager
 - Thermal Mapper
 - Ion and Neutral Mass Spectrometer
 - Flux Gate Magnetometer
- **Powered by two Advanced Stirling Radioisotope Generators (ASRGs)**
- **Launch Mass: 1946 kg**
- **Launch Date: 2021 on Atlas V 401**
- **Orbit: 46-degree inclined orbit at Jupiter with multiple Io flybys**

Cost Risk Analysis S-Curve

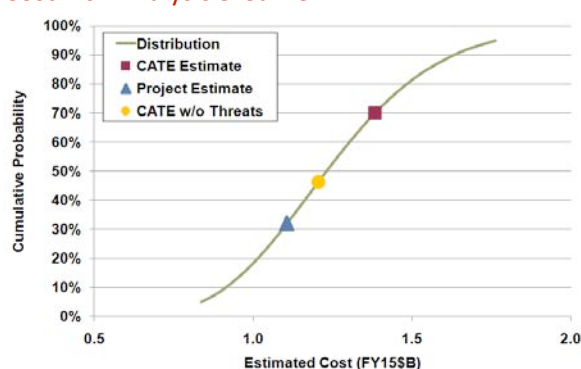

Jupiter Europa Orbiter

Flagship-class Europa Orbiter

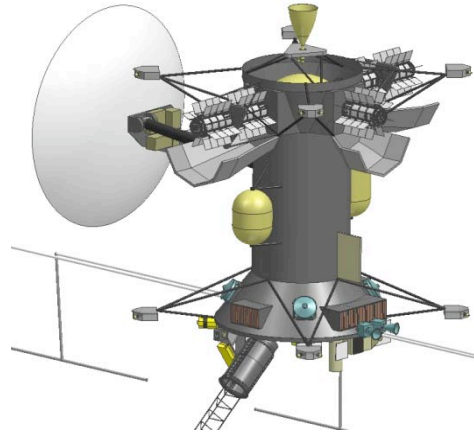

SOURCE: NASA Mission Study (transmitted from Curt Niebur, NASA SMD/Planetary Science Division)

Key Challenges

- **Radiation**
 - Systems engineering for electronics vault repartitioning
 - “Fail operational” fault management to handle environment
- **Mass**
 - Uncertainty in instrument and shielding mass
 - Low launch margin for this development phase
 - Overall sensitivity of system mass to changes
- **Power**
 - System impacts of changing number and design of radioisotope power system units
 - Availability of plutonium-238
- **Instruments**
 - Uncertainties in design of model payload

Scientific Objectives

- **Explore Europa to investigate its habitability**
- **Key science themes:**
 - Characterize the extent of the europian ocean and its relation to the deeper interior
 - Characterize the ice shell and any subsurface water including the nature of the surface-ice-ocean exchange
 - Determine global surface compositions and chemistry, especially related to habitability
 - Understand the formation of surface geology, including sites of recent or current activity and characterize sites for future in situ exploration
 - Understand Europa in the context of the Jupiter system

Key Cost Element Comparison

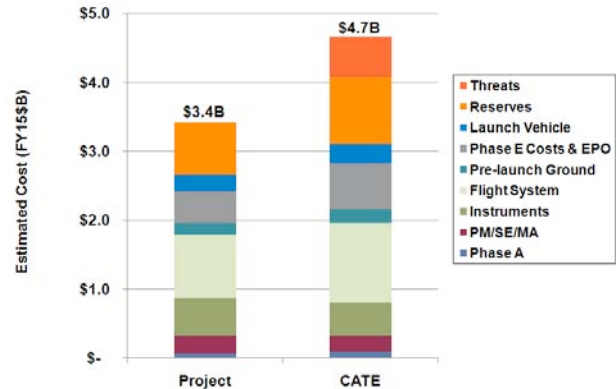

Key Parameters

- **Model Payload**
 - Ocean: Laser Altimeter, Radio Science
 - Ice: Ice Penetrating Radar
 - Chemistry: Vis-IR Imaging Spectrometer, UV Spectrometer, Ion and Neutral Mass Spectrometer
 - Geology: Thermal Instrument, Narrow Angle Imager, Wide and Medium Angle Imager
 - Particles and Fields: Magnetometer, Particle and Plasma Instrument
- **Five Multi-Mission Radioisotope Thermal Generators**
- **Launch Mass: 4745 kg**
- **Launch Date: 2020 (on Atlas V 551)**
- **Orbit: 100-200 km Europa orbit + jovian tour**

Cost Risk Analysis S-Curve

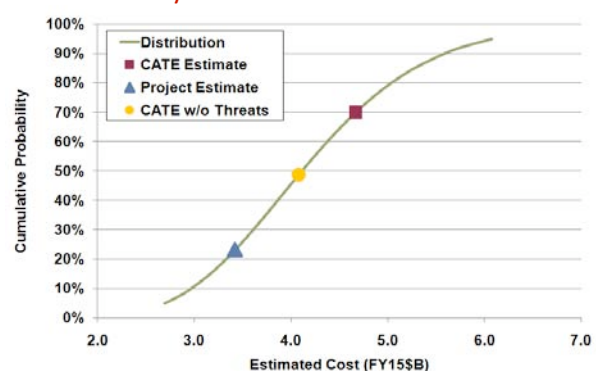

Trojan Tour and Rendezvous

Trojan Tour and Rendezvous Spacecraft

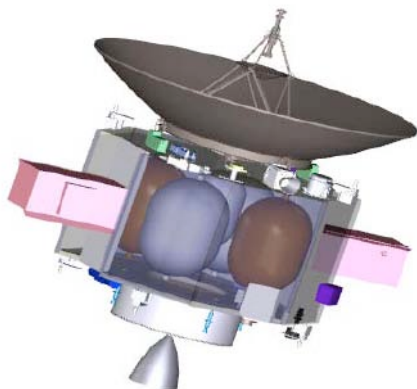

SOURCE: NASA Mission Study (transmitted from Lindley N. Johnson, NASA SMD/Planetary Science Division)

Key Challenges

- **System Power**
 - No power growth contingencies currently allocated
 - May limit downlink capability and science operations
- **System Mass**
 - Low mass contingencies and launch margin for this phase of development

Scientific Objectives

- **Visit, observe, and characterize multiple Trojan asteroids**
- **Key science themes:**
 - Characterize the bulk chemical composition of a Trojan asteroid surface
 - Observe the current geologic state of the surface and infer past evolution and the relative importance of surface processes
 - Characterize the bulk physical properties and interior structure of a Trojan asteroid
 - Search for or constrain outgassing from subsurface volatiles

Key Cost Element Comparison

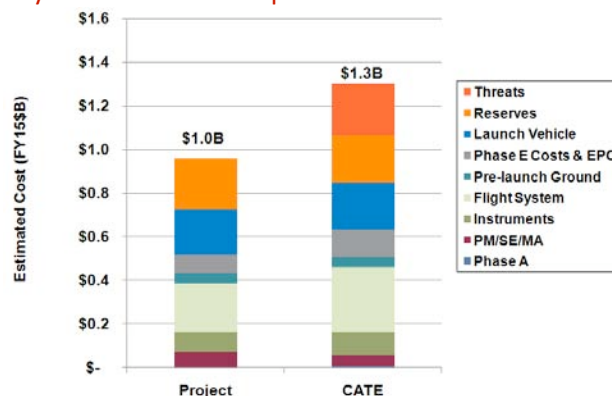

Key Parameters

- **Payload**
 - Wide- and Narrow-Angle Imagers
 - Infrared Mapping Spectrometer
 - Thermal Imager
 - Ultraviolet Spectrometer
 - Gamma Ray Spectrometer
 - Neutron Spectrometer
 - LIDAR
- **Two Advanced Stirling Radioisotope Generators**
- **Launch Mass: 1176 kg**
- **Launch Date: 2019 (on Atlas V 411)**
- **Orbit: One Trojan orbit (~ 50 to 100 km) + multiple Trojan flybys**

Cost Risk Analysis S-Curve

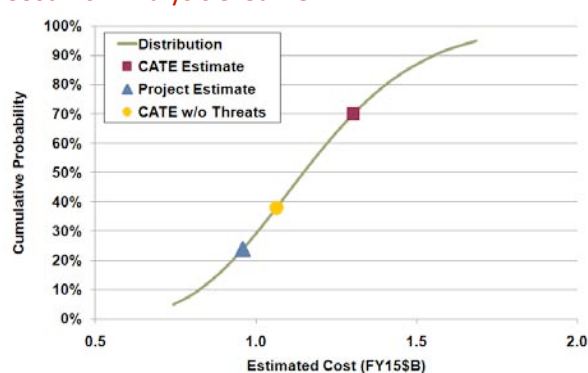

Saturn Probe

Saturn Atmospheric Entry Probe



SOURCE: NASA Mission Study (transmitted from Leonard Duzinski, NASA SMD/Planetary Science Division)

Key Challenges

- **Entry Probe**
 - Time elapsed since mass spectrometer heritage mission
 - High-tempo operations after long hibernation period
 - Reproduction of heritage thermal protection system manufacturing process
- **Payload Requirements Growth**
 - Concept study indicates multiple probes is a consideration though baseline design has a single probe
 - Instrument suite is minimal and possible future design iterations may consider enhanced payloads

Scientific Objectives

- **Determine noble gas abundances and isotopic ratios of hydrogen, carbon, nitrogen, and oxygen in Saturn's atmosphere**
- **Determine the atmospheric structure at the probe descent location**
- **Key science themes:**
 - Constrain models of solar system formation and the origin and evolution of atmospheres
 - Provide a basis for comparative studies of the gas and ice giants
 - Provide a link to extrasolar planetary systems

Key Cost Element Comparison

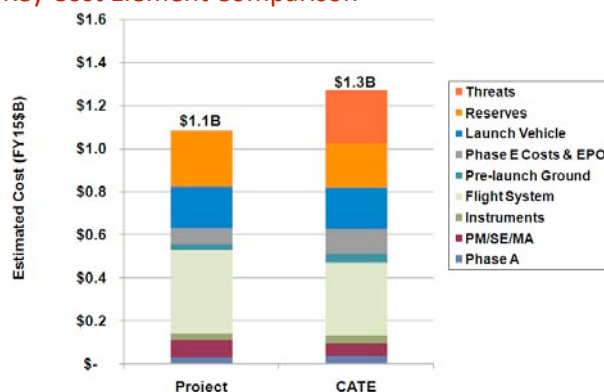

Key Parameters

- **Entry Probe Payload**
 - Mass Spectrometer
 - Atmospheric Structure Instrument
- **Carrier-Relay Spacecraft Bus**
- **Two Advanced Stirling Radioisotope Generators**
- **Launch Mass: 957 kg**
- **Launch Date: 2027 (on Atlas V 401)**
- **Probe: Direct Entry to Saturn, Carrier-Relay: Saturn Flyby**

Cost Risk Analysis S-Curve

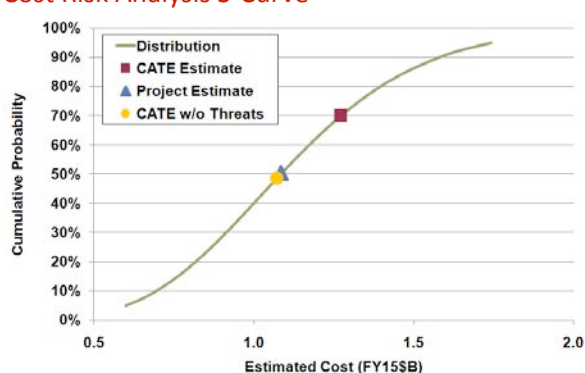

Titan Saturn System Mission

Titan Orbiter + In Situ Elements

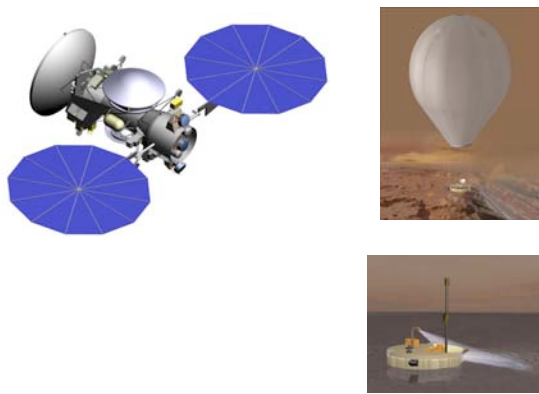

SOURCE: NASA Mission Study (transmitted from Curt Niebur, NASA SMD/Planetary Science Division)

Key Challenges

- **In Situ ESA-supplied Elements**
 - Uncertainty in accommodation, pending element maturation
 - Element operations and communications relay using Orbiter
- **Mass**
 - Uncertainty in instrument mass
 - Low launch margin for this development phase
- **Power**
 - Battery recharge time in Titan orbit
 - Impact of switching to MMRTGs from ASRGs

Scientific Objectives

- Explore Titan as an Earth-like system
- Examine the organic chemistry of Titan’s atmosphere
- Explore Enceladus and Saturn’s magnetosphere for clues to Titan’s origin and evolution
- **Key science themes:**
 - Exploring organic-rich environments
 - Origin and evolution of satellite systems
 - Understanding dynamic planetary processes

Key Cost Element Comparison

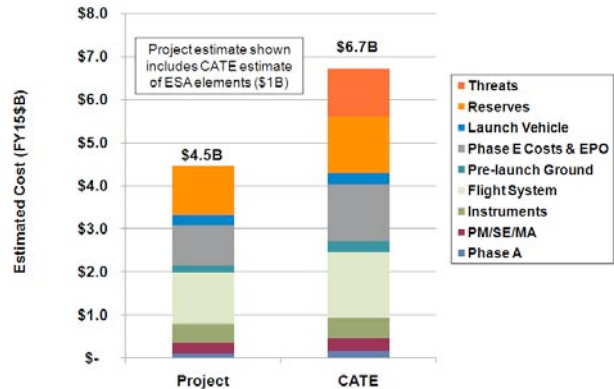

Key Parameters

- **Model Payload**
 - High Resolution Imager and Spectrometer
 - Titan Penetrating Radar and Altimeter
 - Polymer Mass Spectrometer, Sub-Millimeter Spectrometer, Thermal Infrared Spectrometer
 - Magnetometer, Energetic Particle Spectrometer, Langmuir Probe, Plasma Spectrometer
 - Radio Science and Accelerometers
- **In Situ Elements: Balloon and Lake Lander**
- **Radioisotope Power Sources: 5 ASRGs + 1 MMRTG**
- **Launch Mass: 6203 kg**
- **Launch Date: 2020 (on Atlas V 551) gravity assist SEP**
- **Orbit: 1500 km Titan orbit + Saturn tour including Enceladus flybys**

Cost Risk Analysis S-Curve

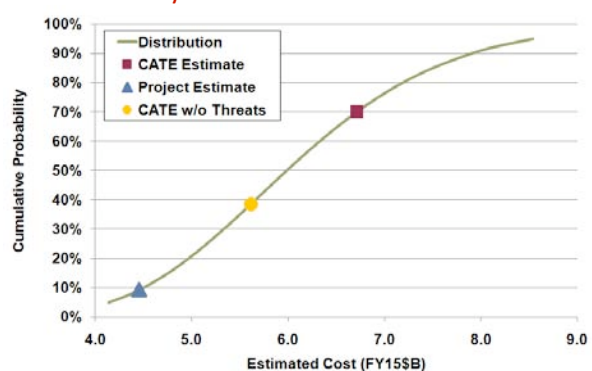

Enceladus Orbiter

Enceladus Orbiter Spacecraft

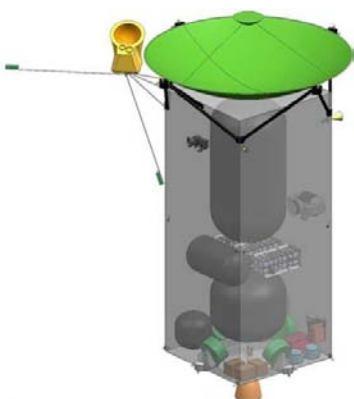

SOURCE: NASA Mission Study (transmitted from Curt Niebur, NASA SMD/Planetary Science Division)

Key Challenges

- **Planetary Protection**
 - Potential modifications to design required if planned Enceladus impact disposal is not acceptable for Planetary Protection
- **Particle Impact Damage**
 - Potential for spacecraft damage from Saturn E-ring or Enceladus plume particle impact
 - Primary concern is High Gain Antenna surface quality
- **System Power**
 - Some potential for reduced science operations with assumed ASRG degradation

Scientific Objectives

- Investigate the internal structure, geology, and chemistry of Enceladus and plumes discovered by Cassini
- Prepare for potential future landing
- Observe interactions between Enceladus and the Saturn system and explore the surfaces and interiors of Saturn's moons
- **Key science themes:**
 - Investigate the nature of Enceladus's cryovolcanic activity
 - Provide improved measurements of plume gas and dust
 - Measure tidal flexing, magnetic induction, static gravity, topography, and heat flow

Key Cost Element Comparison

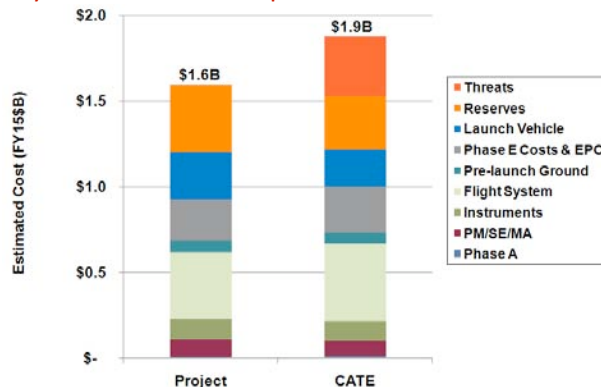

Key Parameters

- **Payload**
 - Medium Angle Imager
 - Thermal Imaging Radiometer
 - Mass Spectrometer
 - Dust Analyzer
 - Magnetometer
- **Three Advanced Stirling Radioisotope Generators**
- **Launch Mass: 3560 kg**
- **Launch Date: 2023 (on Atlas V 521)**
- **Orbit: Enceladus orbit (100 km x 267 km, 62 deg inclination) plus Saturn satellite tour**

Cost Risk Analysis S-Curve

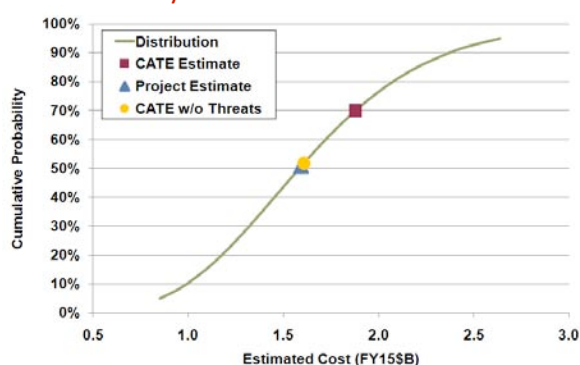

Uranus Orbiter and Probe

Uranus Orbiter with Solar-Electric Propulsion and Entry Probe

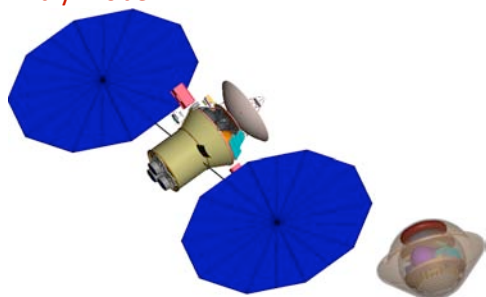

SOURCE: NASA Mission Study transmitted from Leonard A. Dudzinski, NASA SMD/Planetary Science Division

Key Challenges

- **Demanding Entry Probe Mission**
 - High-tempo operations just prior to orbit insertion
 - Probe mass spectrometer
 - High probe deceleration environment at entry
- **Long Life (15.4 years) for Orbiter**
 - Ensuring reliability and performance of ASRGs
- **High Magnetic Cleanliness for Orbiter**
 - Demanding requirement to reduce spacecraft magnetic noise to 0.1 nT background
- **System Mass and Power**
 - Low-mass and -power margins for this phase
 - High mass multiplying factor from large propulsion delta-V requirements

Scientific Objectives

- Investigate the interior structure, atmosphere, and composition of Uranus
- Observe the Uranus satellite and ring systems
- Key science themes:
 - Determine atmospheric zonal winds and structure
 - Understand Uranus’s magnetosphere and interior dynamo
 - Determine noble gas abundances and isotopic ratios of H, C, N, and O within Uranus’s atmosphere
 - Determine the internal mass distribution of Uranus
 - Determine horizontal distribution of atmospheric thermal emission
 - Observe Uranus’s satellites

Key Cost Element Comparison

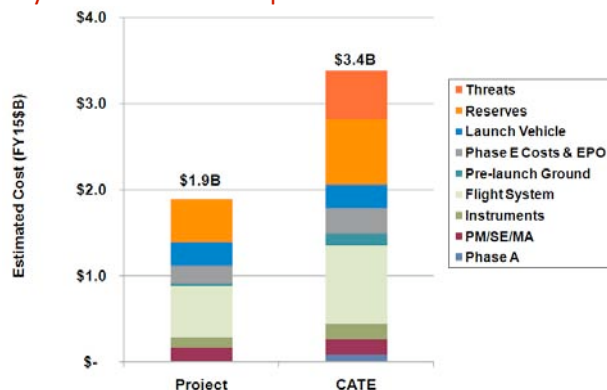

Key Parameters

- **Orbiter Payload**
 - Wide- and Narrow-Angle Imagers
 - Visible/Near-Infrared Mapping Spectrometer
 - Ultraviolet Imaging Spectrograph
 - Mid-Infrared Thermal Detector
 - Plasma Instruments(2), Magnetometer, Ultra-stable Oscillator
- **Entry Probe Payload**
 - Mass Spectrometer
 - Atmospheric Structure Instrument, Nephelometer
 - Ultra-stable Oscillator
- **Three Advanced Stirling Radioisotope Generators**
- **Launch Mass: 4129 kg**
- **Launch Date: 2020 (on Atlas V 531)**
- **Orbit: 1.3 Ru x 51.3 Ru, 97.7 deg inclined orbit + Satellite tour**

Cost Risk Analysis S-Curve

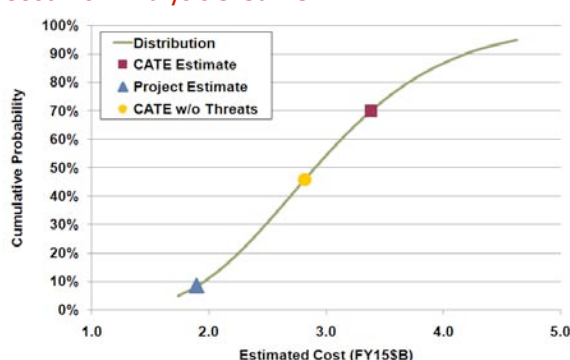

Uranus Orbiter and Probe (no SEP)

Uranus Orbiter with Entry Probe

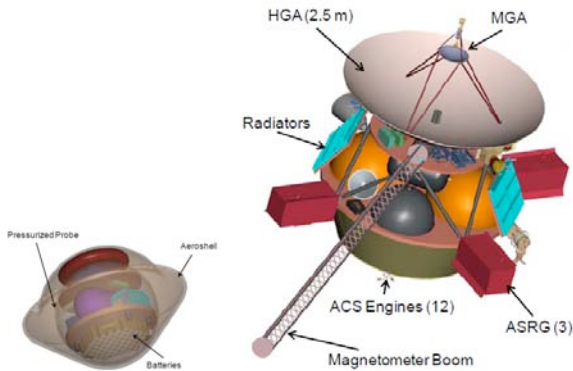

SOURCE: NASA Mission Study (transmitted from Leonard A. Dudzinski, NASA SMD/Planetary Science Division)

Key Challenges

- **Demanding Entry Probe Mission**
 - High-tempo operations just prior to orbit insertion
 - Probe mass spectrometer
 - High probe deceleration environment at entry
- **Long Life for Orbiter**
 - Ensuring reliability and performance of ASRGs
- **System Power**
 - Low power margins for this phase
- **Sensitivity of Launch Opportunities to System Mass**
 - More trajectory analyses recommended
- **High Magnetic Cleanliness for Orbiter**
 - Demanding requirement to reduce spacecraft magnetic noise to 0.1 nT background

Scientific Objectives

- Investigate the interior structure, atmosphere, and composition of Uranus
- Observe the Uranus satellite and ring systems
- Key science themes:
 - Determine atmospheric zonal winds and structure
 - Understand Uranus’s magnetosphere and interior dynamo
 - Determine noble gas abundances and isotopic ratios of H, C, N, and O within Uranus’s atmosphere
 - Determine the internal mass distribution of Uranus
 - Determine horizontal distribution of atmospheric thermal emission
 - Observe Uranus’s satellites

Key Cost Element Comparison

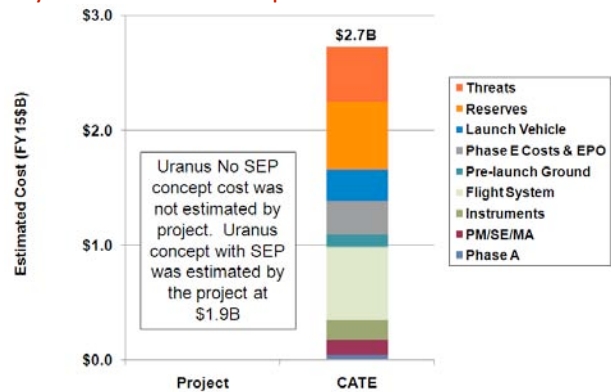

Key Parameters: Descope Concept

- Uranus Orbiter and Entry Probe identical to original proposed concept
- Mission identical, except
 - Launch Mass: 2245 kg
 - Launch Date: 2019 (on Atlas V 551)
- Descope assumptions
 - No Solar-Electric Propulsion (SEP) stage
 - Chemical propulsion trajectory with gravity assist flybys

Cost Risk Analysis S-Curve

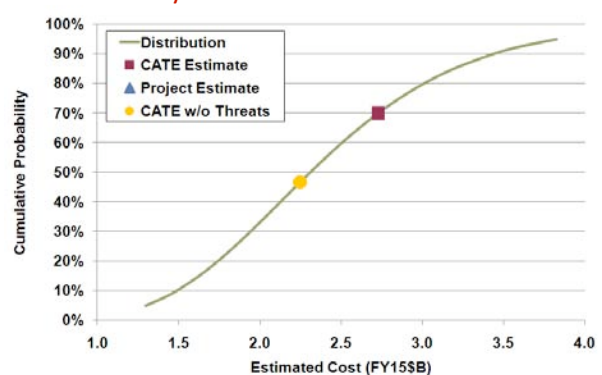

Comet Surface Sample Return

Comet Sample Return Orbiter

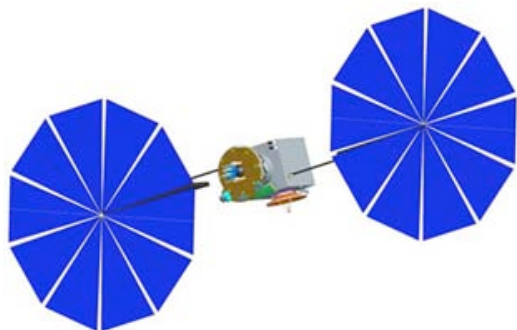

SOURCE: NASA Mission Study (transmitted from Lindley N. Johnson, NASA SMD/Planetary Science Division)

Key Challenges

- **Sample Acquisition**
 - *Brush Wheel Sampler needs to be integrated into system design*
 - *Spacecraft control during touch and go sampling needs to be addressed*
- **Mission Design**
 - *Access to surface characterized comets within current schedule*
 - *Trajectory constraints with 1+1 solar-electric propulsion system and Atlas V 521*
- **System Mass**
 - *Low mass contingencies and launch margin for this phase of development*

Scientific Objectives

- **Acquire and return to Earth for laboratory analysis a macroscopic (≥ 500 cc) comet nucleus surface sample**
- **Characterize the surface region sampled**
- **Preserve sample complex organics**
- **Key science themes:**
 - *Physical and chemical conditions in the outer solar system during its formation*
 - *History of the early solar system through age dating of cometary grains*
 - *Comets as purveyors of water and organics throughout the solar system*
 - *Understanding the nature of giant planet cores*

Key Cost Element Comparison

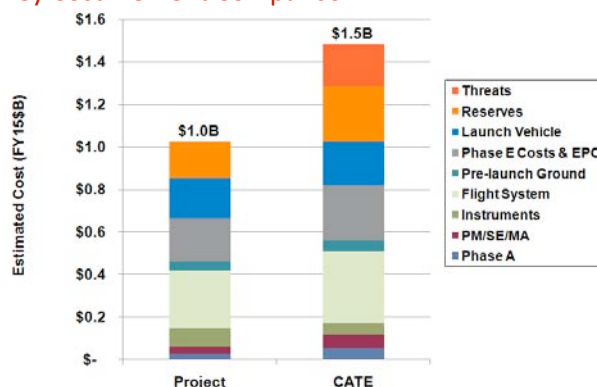

Key Parameters

- **Payload**
 - *Brush-Wheel Sample Acquisition System*
 - *Sample Return Vehicle*
 - *Sample Monitoring: sample imagers, temperature and pressure sensors*
 - *Site Characterization: Narrow Field Visible Imager, Wide Field Visible Imager, Thermal Infrared Imager*
- **17.4 kW (1AU Beginning of Life) Ultraflex power system (6.3 m diameter)**
- **Launch Mass: 1865 kg**
- **Launch Date: 2015 (on Atlas V 521)**
- **Orbit: 1 km comet orbit + touch and go surface sampling followed by Earth return**

Cost Risk Analysis S-Curve

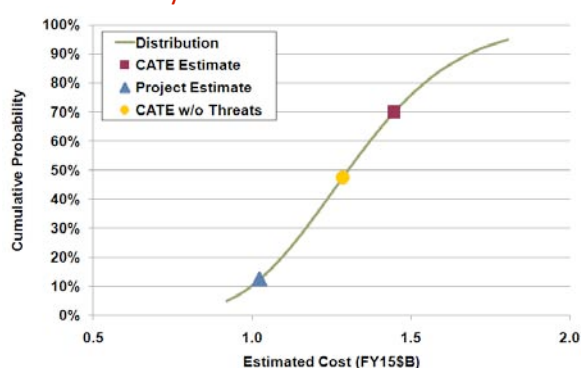

SUMMARY

Linked technical, cost, and schedule estimates were developed for each of the priority mission concepts selected by the committee. The use of historical experience databases and evaluation of the technical risk, cost, and schedule histories of analogous space systems which had already flown plus the extensive interaction of technical, cost, and schedule experts with the proposing teams provide, in toto, a high degree of confidence that the resulting assessments are realistic and credible.

The CATE process derived mission costs that are considerably higher than the cost estimates provided by the design center study teams. The reason is that project-derived cost estimates are typically done via a bottoms-up or “grass roots” approach, and beyond standard contingencies they do not include probabilities of risk incurred by necessary redesigns, schedule slips, or launch vehicle growth. In other words, these estimates typically do not account for the “unpleasant surprises” that historically happen in nearly all space mission developments.

CATEs include a probabilistic assessment of required reserves assuming that the concept achieves the mass and power as allocated or constrained by the respective stated project contingencies within the schedule as stated by the project. In addition to these reserves, additional cost threats are also included that quantify potential cost growth based on design maturity (mass and power growth) and schedule growth. Potential cost threats for larger required launch vehicle capability are also included. It is the combination of these reserves and cost threats that are often the main reason for the large differences between the CATE appraisal and the project estimate. Differences in the estimates for hardware costs (instruments and flight systems) can also be a contributing factor.

As noted in several places in this report, the planetary program has been plagued for many years by use of cost estimates that in retrospect turn out to have been too optimistic. The result has been cost overruns that can be highly disruptive to the program. The CATE process, which uses history as its guide, has been designed, and used in this decadal survey, to prevent this problem.

REFERENCES

1. National Research Council, *An Assessment of Balance in NASA's Science Programs*, The National Academies Press, Washington, D.C., 2006, p. 32.
2. National Research Council, *An Assessment of Balance in NASA's Science Programs*, The National Academies Press, Washington, D.C., 2006, p. 33.
3. National Research Council, *Decadal Science Strategy Surveys: Report of a Workshop*, The National Academies Press, Washington, D.C., 2007, pp. 21-30.
4. National Research Council, *NASA's Beyond Einstein Program: An Architecture for Implementation*, The National Academies Press, Washington, D.C., 2007, pp. 66-114.
5. Congress of the United States, *National Aeronautics and Space Administration Authorization Act of 2008*, Public Law 110-422, Section 1104b, October 15, 2008.
6. National Research Council, *New Worlds, New Horizons in Astronomy and Astrophysics*, The National Academies Press, Washington, D.C., 2010, Appendix C.

..
..

D

Other Missions Considered

The missions discussed in Chapters 4-8 which were not selected for analysis via The Aerospace Corporation's CATE methodology (Appendix C) included the following (in approximate order of distance from the Sun):

- Mercury Lander
- Venus Mobile Explorer
- Venus Intrepid Tessera Lander
- Lunar Polar Volatiles Explorer
- Mars Sky Crane Capabilities
- Mars Geophysical Network
- Mars Polar Climate Mission
- Ganymede Orbiter
- Titan Lake Probe
- Chiron Orbiter
- Neptune-Triton-KBO Mission.

These missions were not subjected to the CATE process because the committee considered them to have lower science merit and/or to be less technically ready than the missions discussed in Appendix C. They are described in more detail in subsequent sections. In addition, four technology oriented studies were also carried out in support of this report. These are:

- Near-Earth Asteroid Trajectory Opportunities in 2020–2024
- Small Fission Power System
- Saturn Ring Observer
- Comet Cryogenic Sample Return.

The full text of the completed study reports for the CATE, non-CATE, and technology studies can be found in Appendix G.

The design centers conducted two types of mission study as described below: rapid mission architecture (RMA) studies and full studies (FMS) of mission point designs. RMAs considered a broad array of mission architectures to find a promising approach. The resulting “point design” could then optionally be subjected to a full mission study.

MERCURY LANDER

A mission concept study performed by the Johns Hopkins University Applied Physics Laboratory Space Department in partnership with NASA's Marshall Space Flight Center and Glenn Research Center.

Overview

The purpose of this rapid mission architecture study was to determine the feasibility of a landed mission to Mercury. This mission concerned fundamental science questions that can be best, or only, achieved by surface operations such as determining Mercury's bulk composition, the nature of the planet's magnetic field, surface history, internal structure, and surface-solar wind interactions.

Science Objectives

- Characterize major and minor elements of the chemical composition of Mercury's surface.
- Characterize the mineralogy and structural state of the materials at Mercury's surface.
- Investigate the magnitude and time dependence of Mercury's magnetic field, at least for one location on the surface.
- Characterize geological activity (e.g. volcanism, tectonism, impact cratering) at scales ranging from regional to local.
- Determine the rotational state of Mercury.

Mission Design

The architecture for the flight system of the Mercury Lander was based on a three-stage concept consisting of a cruise stage, braking stage, and final descent and soft landing stage. Because of the complexities associated with a landed mission to Mercury, analysis of scientific instrumentation was not included in this study, which instead focused on the viability of flight system and landing elements.

The 2018-2023 timeframe was chosen for launch, with landings planned approximately 5 years after launch; specific dates dependent on trajectory type. Landed operations were modest in scope, with 22 contiguous days planned for science operations with a possible extension of an additional 68 days dependent on mission success.

Mission Challenges

Because a landed mission to Mercury is extremely challenging from a launch-energy and relative-velocity point of view, two trajectory approaches were considered:

- A ballistic/chemical approach fitting on the edge of Atlas V 551 constraints; and
- A low thrust option using a solar electric propulsion (SEP) cruise stage dependent on high-temperature solar cell technology that has yet to be developed beyond the cell level.

Using an Atlas V 551 launch vehicle, a ballistic/chemical option with a reduced payload and favorable trajectory performance assumptions was estimated at the lowest cost, with more expensive options utilizing solar-electric propulsion and a similar launch vehicle or a chemical propulsion system using a Delta IV Heavy.

Additional challenges identified included the availability of an ASRG and the plutonium-238 to fuel it.

Conclusions

Because of the complex and challenging nature of this mission, a more detailed characterization study is recommended before moving forward with the Mercury Lander concept. Both SEP and ballistic trajectory approaches and concepts should be further explored with a more detailed mission design and concept definition to determine the preferred mission implementation approach. Currently each has benefits and risks that could not be fully characterized at this level of study.

VENUS MOBILE EXPLORER

A mission concept study performed by NASA's Goddard Space Flight Center.

Overview

The purpose of this rapid mission architecture study was to determine whether a Venus mission with surface, or near-surface, mobility and realistic operational lifetime could achieve meaningful surface science at two or more independent locations separated by several kilometers. Of particular interest was a metallic bellows concept for aerial mobility.

Science Objectives

- Determine origin and evolution of Venus' atmosphere, and rates of exchange of key chemical species between the surface and atmosphere.
- Characterize fundamental geologic units in terms of major rock forming elements, minerals in which those elements are sited, and isotopes.
- Characterize geomorphology and relative stratigraphy of major surface units.

Mission Design

This mission's space segments consist of a probe and flyby carrier spacecraft that is also used as a communications relay. The probe consists of two top-level elements: the entry and descent element, which includes the aeroshell and parachute systems; and the lander. The lander has two major systems: the gondola that carries the science instruments and subsystems inside a thermally protected pressure vessel; and, the bellows aerial mobility system, including the bellows and the inflation subsystems. Two 20-day launch windows were considered in 2021 and 2023 with an initial flyby and second Venus encounter approximately 112 days later.

Mission Challenges

Significant development risks include bellows concept development; safe landing assurance; test facilities for large test articles to simulate Venus' high temperature, pressure and chemical environment; critical events timing; and laser Raman/laser-induced breakdown spectrometer development. Operation risks include bellows mobility, safe landing, and aeroshell operations. Uncertainty exists in the technology development cost, due to the relative immaturity of some of the essential technologies.

PREPUBLICATION COPY—SUBJECT TO FURTHER EDITORIAL CORRECTION

D-3

Conclusions

Based on analyses of the mechanical, thermal, power, avionics, and communication designs for the probe and the carrier spacecraft, a Venus mission using the metallic bellows architecture for short-lived (~5 hrs) aerial mobility is technically feasible. The cost estimate for the nominal baseline mission was estimated to be in the flagship range. The cost is driven by the metallic bellows and supporting mechanisms for its operation. Technology development, accommodation, and complex integration also contribute to the high cost of the probe.

VENUS INTREPID TESSERA LANDER

A mission concept study performed by NASA's Goddard Space Flight Center and NASA's Ames Research Center.

Overview

The purpose of this enhanced rapid mission architecture study was to investigate a mission capable of safely landing in one of the mountainous tessera regions of Venus. This mission concept provides key measurements of surface chemistry and mineralogy and imaging of a tessera region, as well as new measurements of important atmospheric species that can answer fundamental questions about the evolution of Venus.

Science Objectives

- Characterize chemistry and mineralogy of the Venus surface.
- Place constraints on the size and temporal extent of a possible ocean in Venus's past.
- Characterize the morphology and relative stratigraphy of surface units.

Mission Design

The mission design elements include a carrier spacecraft to be used as a communications relay and a two-element probe. The probe elements are: the Venus lander; and the entry and descent element including aeroshell and parachute systems. The lander's design focuses on enabling a safe landing in the rough tessera terrain. The launch opportunity considered was for 2021, with fly-by and descent/landing mission elements in 2022.

Mission Challenges

The most significant challenges posed by this mission were related to the development of a high-TRL level Raman/laser-induced breakdown spectroscopy (LIBS) system, safe landing, and testing at Venus environmental conditions. To reduce risk, advancements in two key technology areas are needed: first, verifying the Raman/LIBS implementation, calibrated operation, and sizing for the Venus surface environment, including high entry loads on the laser and second, additional analyses and testing to ensure safe landing in potentially rugged terrains (at lander scales).

PREPUBLICATION COPY—SUBJECT TO FURTHER EDITORIAL CORRECTION

D-4

Conclusions

Venus' tessera provide fundamental clues to the planet's past, but, the terrain has been viewed as largely inaccessible for landed science due to their known roughness. Based on analyses of the landing dynamics, mechanical, thermal, power, optics, avionics, and communication designs for this mission, a robust spacecraft capable of landing safely in the tessera terrain, conducting surface science and transmitting all data back to Earth via the telecom-relay spacecraft is technically feasible. However, because the Venus In Situ Explorer and Venus Climate Mission were judged of higher priority combined with considerations of program balance, this mission was not considered further as a decadal option.

LUNAR POLAR VOLATILES EXPLORER

A mission concept study performed by NASA's Marshall Space Flight Center in cooperation with the Johns Hopkins University Applied Physics Laboratory.

Overview

The purpose of this rapid mission architecture study was to determine the feasibility of a mission to investigate putative volatiles in permanently shadowed areas of the lunar poles. While previous orbital missions have provided data that support the possibility of water ice deposits existing in the polar region, this concept seeks to understand the nature of those volatiles by direct in-situ measurement.

Science Objectives

- Determine the form and species of the volatile compounds at the lunar poles.
- Determine the vertical distribution and concentration of volatile compounds in the lunar polar regolith.
- Determine the lateral distribution/concentration of volatile compounds in the lunar polar regolith.
- Determine the secondary alteration mineralogy of regolith.
- Determine the composition and variation in the lunar exosphere adjacent to cold traps.

Mission Design

The mission concept explored involves placing a lander and instrumented rover in a permanently shadowed crater near one of the Moon's poles. The rover would carry a suite of science instruments to investigate the location, composition, and state of volatiles. Rovers powered by batteries and radioisotope power systems (RPS) were considered. A battery-powered option, designed to support 4.4 days of surface operations, could achieve some, but not all, the mission's top science goals. The development of the mission was assumed to start in 2013 to support an October 2018 launch.

Mission Challenges

Although this study identifies several mission components at TRLs less than 6, the required technology advancements are believed to be achievable and consistent with the outlined mission schedule.

PREPUBLICATION COPY—SUBJECT TO FURTHER EDITORIAL CORRECTION

D-5

Technology development was found to be required for the rover LIDAR, the drill and sample acquisition system, the RPS, and terrain relative navigation.

Additional identified risks to the mission include: drill performance; thermal environment effects; high thrust-to-weight bi-propellant thruster qualification; soft landing precision guidance, navigation, and control; low mass and power avionics development; availability of plutonium-238, and battery mission-mass growth.

Conclusions

A lunar polar volatiles mission represents an important opportunity to study the nature, composition and dynamics of volatiles trapped in the frigid interiors of lunar polar impact craters. It also provides an opportunity to investigate polar volatiles, especially water ice, as a potential resource for future human exploration of the Moon and destinations beyond. Although such a mission retains a high science value, the polar crater environment presents a number of technical challenges, including rover survivability, sample collection and characterization, and navigation. Although some technical maturation is required, there remain no major impediments to such a mission within this decade.

MARS SKY CRANE CAPABILITIES

A capabilities study performed by NASA's Jet Propulsion Laboratory

Overview

The purpose of this special study was not focused on a mission but to explore the full range of science capabilities that could be delivered to the surface of Mars by a Mars Science Laboratory (MSL)-derived Sky Crane entry, descent, and landing system. Of particular interest were options to address pathways to three broad classes of surface science and the differences between delivering mobile and fixed systems. In addition, the study investigated the potential capabilities of the Sky Crane with respect to landing ellipse, landing altitude, and landed mass. Special attention was paid to options for the 2018 launch opportunity.

Surface Science Pathways

- *Surface Fieldwork - Astrobiology/Geology Pathway* emphasized the geological and geophysical evolution of Mars; the history of its volatiles and climate; the nature of the surface and subsurface environments, now and in the past; the temporal and geographic distribution of liquid water; and the availability of other resources (e.g., energy) necessary to sustain life.
- *Access to the Subsurface - Geology/Astrobiology Pathway* emphasized conducting several experiments (including subsurface sampling) at sites where records of recent climate, geologic processes, and organic molecules might well be preserved and accessible in the near subsurface.
- *Network Science Pathway* emphasized strategies for deployment of network investigations using seismological and meteorological measurement methods to study both the Martian atmosphere and subsurface characteristics.

Mission Design

An initial assessment of more than a dozen potential design elements was performed. After favorable study elements were identified and placed in combination, these new groups were also examined for feasibility and effectiveness in meeting the stated science objectives. All study architectures assumed a MSL-derived Sky Crane descent system to deliver the science payloads to the surface; however, the main trades for the study were the sets of science payloads that could be delivered in the 2018 Mars opportunity.

The individual mission elements studied for this investigation were: MAX-C Rover, ExoMars, Network Pathfinder, Seismic Drop Package, and Subsurface Station. It was determined that the science pathway objectives could be fulfilled by a combination of these mission elements as described below.

Mission Options

- *Baseline—MAX-C and ExoMars.* Pathways addressed: Surface Field Geology/Astrobiology and Subsurface Geology/Astrobiology.
- *Option 2—MAX-C, ExoMars, and Network Pathfinder.* Pathways addressed: Surface Field Geology/Astrobiology, Subsurface Geology/Astrobiology and Network Science.
- *Option 3—MAX-C, Network Pathfinder, and Seismic Drop Package.* Pathways addressed: Surface Field Geology/Astrobiology and Network Science
- *Option 4—MAX-C and Subsurface Station.* Pathways addressed: Surface Field Geology/Astrobiology, Subsurface Geology/Astrobiology and Network Science

Conclusions

All of these mission options—with the exception of Option 2—are technically feasible based on technical maturity and mass margins. Despite these conclusions, further assessments of relevant planetary protection requirements and specific instrumentation development must be performed before further recommendations on the implementation of the Mars Sky Crane system can be made.

MARS GEOPHYSICAL NETWORK

A mission concept study performed by NASA's Jet Propulsion Laboratory

Overview

The purpose of this full mission study was to investigate a geophysical network mission for Mars. After an initial trade-study, a two-lander mission concept was selected.

Science Objectives

- Characterize the internal structure to better understand its early planetary history and internal processes affecting its surface and habitability.
- Characterize the thermal state of Mars to better understand its early planetary history and internal processes affecting its surface and habitability.

PREPUBLICATION COPY—SUBJECT TO FURTHER EDITORIAL CORRECTION

D-7

- Characterize the local meteorology and provide ground truths for orbital climate measurements.

Mission Design

The mission studied includes two independent, identical spacecraft. Each spacecraft consists of a lander, an entry system, and a cruise stage. These elements would be combined in a Phoenix-like architecture with a powered-descent lander. The main instrument on each lander is a seismometer.

The mission would nominally launch on a single Atlas V 401 launch vehicle. Both horizontal (stacked) and vertical (parallel) launch configurations were considered. Although the latter configuration would mitigate the risk of separation failure of the first lander affecting deployment of the second lander, the former configuration was ultimately chosen to simplify development and to forgo the need for a larger launch vehicle. September 2022 was chosen as the nominal launch date for this study, followed by typical cruise duration of some 6 months.

Mission Challenges

The concept was susceptible to common risks associated with Mars in-situ vehicles. The most prominent risks identified were failure of the entry, descent and landing (EDL) system of one or both landers. Due to the concept's design heritage, most notably derived from the Phoenix mission, no significant technology development program was deemed necessary.

Conclusions

Both instrumentation and spacecraft architecture benefit from an established technology base and therefore are considered at a high level of technological maturity. Most mission- and operations risks stem from the simultaneous launch and deployment of two spacecraft requiring separate EDL. The mission was given lower scientific priority, however, than the Mars missions recommended in Chapter 9.

MARS POLAR CLIMATE MISSION

A mission concept study performed by NASA's Jet Propulsion Laboratory

Overview

A rapid mission architecture study was conducted to explore which science objectives related to the study of the martian climate via the record preserved in the polar-layered deposits could be pursued by small- to moderate-size mission. Five concepts were studied: two orbiters, two stationary landers, and a mobile lander.

Science Objectives

- Understand the mechanism and chronology of climate change on Mars.
- Determine the age and evolution of the polar-layered deposits (PLDs).
- Determine the astrobiological potential of the observable water-ice deposits.

PREPUBLICATION COPY—SUBJECT TO FURTHER EDITORIAL CORRECTION

D-8

- Determine the mass and energy budget of the PLDs and how volatiles and dust have been exchanged between polar and non-polar reservoirs.

Mission Design

The orbiter mission scenarios were a small orbiter with two payload options, and a medium-size orbiter combining most of the payload options from the small orbiters. Also investigated were a small stationary lander and a small-/medium-class stationary lander with a meter-scale drill. The final mission scenario was for medium-class rover with an ice sampler/rock corer, similar to the one envisioned for the Mars Astrobiology Explorer-Cacher, as well as spectrometry instruments.

Mission Challenges

While no formal risk assessment was conducted for this study, it identified several areas of necessary or beneficial technology development. For orbiters, Ka-band telecommunications were envisioned, pending implementation with the Deep Space Network. All lander options assumed the availability of telecommunications relay orbiters. In addition, all landers considered in the study were likely to require precision-guided entry, pending demonstration by the Mars Science Laboratory. Some of the missions considered would also benefit from the Advanced Stirling Radioisotope Generators, which are currently under development and may be subject to reliability and logistics issues regarding the availability of plutonium-238.

Conclusions

The variety of mission concepts discussed covered a significant breadth of options for exploring Mars's polar-layered deposits. No prioritization between these options was detailed, but the study served to illustrate the trade-space studies and instrumentation options for each of the concepts.

GANYMEDE ORBITER

A mission concept study performed by NASA's Jet Propulsion Laboratory

Overview

The purpose of this full mission study was to develop an architecture suitable to perform a scientifically viable Ganymede orbiter mission and to determine the feasibility of a NASA-only Ganymede mission in case the ESA Jupiter Ganymede Orbiter is not realized. Increased mission duration and modest enhancements to the flight system were also considered to accommodate enhanced payloads for a "Baseline" and an "Augmented" mission.

Science Objectives

- Further characterize Ganymede's subsurface ocean.
- Investigate Ganymede's geology including history, tectonism, icy volcanism, viscous modification of the surface, and the nature of surface contact with the ocean.

PREPUBLICATION COPY—SUBJECT TO FURTHER EDITORIAL CORRECTION

D-9

- Characterize Ganymede’s unique magnetosphere and determine the methods by which the magnetic field is generated.
- Investigate Ganymede’s origins and evolution.
- Characterize Ganymede’s gravity anomalies and place constraints on the size and composition of its core and rocky and icy mantles.
- Study Ganymede’s interaction with the rest of the Jovian system.
- Characterize the variability of Ganymede’s atmospheric composition and structure in space and time.
- Further characterize Callisto’s interior and subsurface ocean.

Mission Design

A mission with three distinct scientific phases was considered: the Ganymede and Callisto flyby phase; a pump-down phase in an eccentric Ganymede orbit; and an orbital tour phase in a circular polar orbit around Ganymede. For the “floor” mission option, the spacecraft would spend 3 months in Ganymede orbit, with orbits of 6 months and 1 year for the “baseline” and “augmented” mission options, respectively.

Floor mission payload included wide-angle and medium-angle cameras, magnetometer, radio science, laser altimeter, visual/near infrared imaging spectrometer, and plasma package. The baseline mission added a mass spectrometer and ultraviolet spectrometer. The augmented mission included all of the above instruments plus radio and plasma wave instruments, narrow-angle camera, and sounding radar.

Each of these options employed a three-axis-stabilized, solar-powered spacecraft with conventional bi-propellant propulsion. The preferred launch date for this mission was in May 2021 with Ganymede arrival in 2028; two other launch opportunities are available in 2023 and 2024.

Mission Challenges

There are no significant technological risks associated with the GO mission, and there is no further technology development required. For the spacecraft, the key required Ganymede flight system elements are being developed and demonstrated for Jupiter applications on the Juno mission. The instruments are all based on technology that is either highly developed or has already flown; for the instruments, the only engineering developments necessary are in response to Ganymede’s high radiation environment.

Conclusions

A Ganymede orbiter mission appears to be technically feasible with no required technology development for the spacecraft, propulsion system, or instrumentation. For all moderate mission risks, mitigation strategies have been incorporated into the final mission architecture. The mission was not given further consideration because of the likelihood that the ESA Jupiter Ganymede Orbiter would achieve most of the same science goals.

TITAN LAKE PROBE

A mission concept study performed by NASA’s Jet Propulsion Laboratory

Overview

The purpose of this RMA study was to develop mission architectures for in-situ examination of a hydrocarbon lake on Titan. To this end, one large-class mission (to be delivered to Titan as part of a larger Flagship Titan mission which was not part of this study) and three stand-alone, medium-class, mission architectures were studied. Distinguishing design trade-offs among these missions included the use direct versus spacecraft-relaying communications, submersible versus floating probes, as well as the application of Advanced Stirling Radioisotope Generators (ASRGs), instrument selection and trajectory design. The sub-solar and sub-Earth points are in Titan's southern hemisphere from 2025 to 2038, and the largest lakes are near the north pole. Therefore, it was important to understand the feasibility of different mission architectures as a function of launch date.

Science Objectives

- Understand the formation and evolution of Titan and its atmosphere through measurement of the composition of the target lake, with particular emphasis on the isotopic composition of dissolved minor species and on dissolved noble gases.
 - Study the lake-atmosphere interaction in order to determine the role of Titan's lakes in the methane cycle.
 - Study the target lake as a laboratory for both prebiotic organic chemistry in water (or ammonia-enriched water) solutions and non-water solvents.
 - Determine if Titan has an interior ocean by measuring tidal changes in the level of the lake over the course of Titan's 16-day orbit.

Mission Design

The large-class lander would consist of both floating and submersible probes. The stand-alone mission options include: a lake-lander using a direct-to-Earth (DTE) communications link; a submersible-only probe with a flyby relay spacecraft; and a lake lander with a flyby relay spacecraft. All missions would require the use of ASRGs, either on the lander for the Flagship and DTE options, or on the relay spacecraft with battery-powered in-situ segments for the remaining options.

The large lander would carry a comprehensive suite of instruments capable of carrying out in-situ measurements of Titan's atmospheric evolution, lake-atmosphere hydrocarbon cycle, and pre-biotic lake chemistry, and of checking for the presence of a subsurface ocean. This list was reduced for the DTE mission, eliminating the submersible instrumentation as well as a few instruments on the lake lander.

The submersible-only mission would carry just the gas chromatograph-gas chromatograph/mass spectrometer (GC-GC/MS), lake properties package, and a Fourier transform infrared spectrometer.

Finally, the lake lander flyby mission would represent the science floor and would contain only the GC-GC/MS and lake properties package. Lake landers for all architectures would be capable of sampling gases and liquids. In addition, both the large and stand-alone submersibles would be able to sample solids from the lake bottom as well as liquids.

Mission Challenges

Moderate risks identified to affect all mission concepts included availability of plutonium-238 for the ASRGs and the reliability thereof. Furthermore, the concepts would require significant technology development to become viable, including instrument development for the cryogenic operating environment. Limitations on the current understanding of the Titan atmospheric and lake behaviors made

landing in the small southern lakes challenging; all architectures thus assumed landings on the much larger Kraken Mare in the north. A requirement to target Kraken Mare constrained the trajectory of the DTE mission since the likely launch opportunity left little time before Earth would no longer be in view from the lake surface. Consequently, a high C3 trajectory was required for this architecture to reduce travel time to Titan, increasing launch mass and launch costs.

Conclusions

The exploration of Titan's hydrocarbon lakes has high scientific potential and the Titan lake lander concepts appear feasible. However, based on the costs and the relatively limited science scope of a stand-alone lake probe without the orbiter and balloon elements, the stand-alone lake probe concepts were judged to be lower priority than a lake probe which was an element of a flagship mission, or some of the other mission concepts studied. The cryogenic environment and lack of heritage in lake probe design necessitates strategic investment in technology development, including cryogenic sample acquisition and handling.

CHIRON ORBITER

A mission concept study performed by NASA's Goddard Space Flight Center.

Overview

The purpose of this rapid mission architecture study was to determine several options for delivering a useful payload into orbit around Chiron. The five options discussed focused mainly on the propulsion and trajectories needed to place a satellite, with a given science package, into orbit around Chiron.

Science Objectives

- Observe current geologic state and composition of surface and infer past evolution and relative importance of surface processes.
- Observe and measure the sporadic outgassing activity and determine the composition of outgassed volatiles.
- Characterize bulk properties and interior structure.

Mission Design

The majority of the engineering work for this study was spent on propulsion, power, and trajectory trades to define how the science payload could be delivered to Chiron within the given constraints, leaving less resource for the definition of the science package. Several trajectories for flights between Earth and Chiron including both direct and flyby orbital trajectories were examined. Launch was determined to occur between 2019 and 2025 depending on propulsion option, with a cruise phase duration between 11 and 13 years.

None of the preliminary propulsion solutions deliver an acceptable mass to Chiron with an 11-year transit time; however, five propulsion options were determined that could deliver acceptable masses into Chiron Orbit with a 13-year transit time as the baseline.

PREPUBLICATION COPY—SUBJECT TO FURTHER EDITORIAL CORRECTION

D-12

Mission Challenges

Because of the inherent complexities in reaching Chiron, the primary challenges discussed in this study relate to propulsion and trajectories needed to orbit Chiron. Budgetary assumptions made in mission study cost assessment do not include the mission launch vehicle. Additional challenges are posed by the availability of plutonium-238 for the ASRGs and the reliability thereof.

Conclusions

Of the five propulsion options considered for trajectories into Chiron orbit, the all-chemical option did not deliver a viable payload. The two solar-electric and chemical propulsion options delivered useful masses with reduced science payloads. Finally, the two radioisotope-electric propulsion (REP) options delivered a viable payload capable of meeting all science requirements. However, the REP system will likely need more than the two ASRGs assumed available for this mission. This study demonstrated the need for continued investments in long-term communication infrastructure and propulsion technologies before such missions could be attempted.

NEPTUNE/TRITON/KBO MISSION

A mission concept study performed by NASA's Jet Propulsion Laboratory and a follow-on full mission study of a Neptune Orbiter with Probe conducted by the Johns Hopkins Applied Physics Laboratory.

Overview

This rapid mission architecture study investigated a set of missions to the Neptune system, including some with the potential for continued travel to a Kuiper belt object (KBO). Several mission architectures were considered, ranging from relatively simple flybys to complex orbiters. This study initially examined a robust orbiter with an atmospheric probe for each Neptune and Uranus, to assess and understand the feasibility and technological differences between the two targets. Neptune is discussed here; Uranus is discussed in Chapter 7.

Science Objectives

- Determine temporal variations of Neptune's atmosphere.
- Chemical characterization of Neptune's atmosphere.
- Understand the structure, dynamics, and composition of Neptune's magnetosphere.
- Understand the chemistry, structure and surface interaction of Triton's atmosphere.
- Understand the interior structure of Triton.
- Determine the age and geological processes that shape the surface of Triton/KBOs
- Understand the spatial distribution of surface composition and how the composition is coupled to geological processes on a given KBO.

Mission Design

The RMA study examined seven flyby architectures of varying complexity and focus on Neptune, Triton or KBOs, a "minimal" orbiter of Neptune, five simple orbiter concepts (one including a shallow

PREPUBLICATION COPY—SUBJECT TO FURTHER EDITORIAL CORRECTION

D-13

atmospheric probe and another a separate KBO-flyby spacecraft), as well as a “high performance” orbiter. All flyby options relied exclusively on chemical propulsion, while all other options included a solar-electric propulsion (SEP) system. The most complex of the simple orbiters and the high-performance orbiter would insert themselves into orbit about Neptune via aerocapture. The remaining orbiter concepts employed chemical propulsion for this purpose. Most architectures, included a 25-kg or 60-kg primary instrument payload (predominantly based on New Horizons heritage). The “high performance” architecture allocated up to 300 kg in payload mass. All missions called for the use of three to six Advanced Stirling Radioisotope Generators (ASRGs), depending on mission architecture.

The follow-on point design full mission study focused on an orbiter mission with limited payload and a shallow atmospheric probe (1 to 5-bar terminal pressure). The studies were limited to trajectories without Jupiter gravity assists in order to assess the difference between identical Uranus and Neptune missions without narrow launch window constraints.

Mission Challenges

All concepts studied had moderate reliability risk due to long mission durations. Furthermore, failure of multiple ASRGs was deemed a moderate risk for all of the “simple orbiter” concepts. The availability of plutonium-238 and other logistical issues associated with ASRGs also incurred moderate implementation risks for all options. For the most elaborate of the simple orbiters and the “high performance” orbiter, the use of aerocapture was identified as necessitating further technology development and therefore posed a moderate programmatic and technical risk. Scheduling constraints were identified for all but the high performance option by the availability of a Jupiter gravity assist maneuver, which would favor a launch between 2016 and 2018, with reduced-performance opportunities sporadically thereafter. Cost increases proportionally from the fly-by missions to the simple and high performance orbiters.

The point design was terminated before full evaluation of risk, cost and schedule as it was deemed less technically feasible than a comparable Uranus mission (Appendix C). A Neptune mission without a Jupiter-flyby gravity assist requires aerocapture for orbit insertion. Aerocapture itself not only adds complexity and risk but also makes probe delivery and orbits that allow Triton encounters more challenging. Even with a SEP system, a mission to Neptune has a long duration and thus higher risks for instruments and spacecraft components.

Conclusions

The flyby mission architectures were deemed to achieve significant science progress since Voyager 2’s visit of Neptune and offer the potential for new KBO science. Even the simplest of the flyby missions exceeded the cost cap of a New Frontiers mission and offered low science return relative to its cost, it was deemed not compelling. More complex missions and orbiters provided a vast gain in science objectives unavailable to flyby missions, but at increased cost; the highest performance option yielded a modest increase in estimated science value for its higher cost. More detailed design work of a “sweet spot” mission design identified technical risks that make a Uranus mission more favorable for the coming decade. Technology development will increase the feasibility of a future Neptune orbiter mission.

E

Decadal Planning Wedge for NASA Planetary Science

The fiscal year (FY) 2011 operating budget for NASA's planetary exploration program is about \$1.46 billion dollars. The President's FY2011 budget request was the part of a 5-year budget projection covering FY2011-2015. In that projection the NASA Planetary Science Division's (PSD's) FY2015 planning budget reaches about \$1.65 billion real-year dollars. The committee used that projection in formulating its recommendations. Beyond FY2015 the committee assumed the PSD budget to include only growth equal to inflation for the remainder of the 2013-2022 period covered in this decadal study (currently set at 2.4% per annum).

As shown in Figure E.1 there are a number of ongoing flight, research and operational programs that have commitments with obligations that extend into the decade. These include the Discovery Program (missions through Discovery-12 as well as missions of opportunity), New Frontiers (New Horizons, Juno, and New Frontiers-3), Lunar programs (Lunar Reconnaissance Orbiter and Lunar Atmosphere and Dust Environment Explorer), Mars flight programs (largely Mars Science Laboratory, MAVEN and NASA's contributions to the ESA-NASA Mars Trace Gas Orbiter as well as extended missions for MER, MRO, Odyssey, MEX), Outer Planets (completion of the Cassini Solstice Mission and early selection of EJSM instruments), and Program Core Functions that include Pu-238 investments, advanced multi-mission operations development, PSD program management and various infrastructure activities.

The planning wedge used in this report (shown in white) grows from about \$500 million in FY2013 to about \$1700 million by FY2022. It must be pointed out, however, that although the integrated real year dollar amount under the wedge is ~\$12.2 billion for the decade, this must cover continued R&A, Discovery and technology programs as well as new starts for New Frontiers and Flagship missions. If R&A and Discovery were to be maintained at current levels, they would require ~\$5 billion of the wedge—in that case the total budget for new mission starts in New Frontiers and Flagships within the planning wedge would be roughly \$7 billion over the 2013-2022 decade.

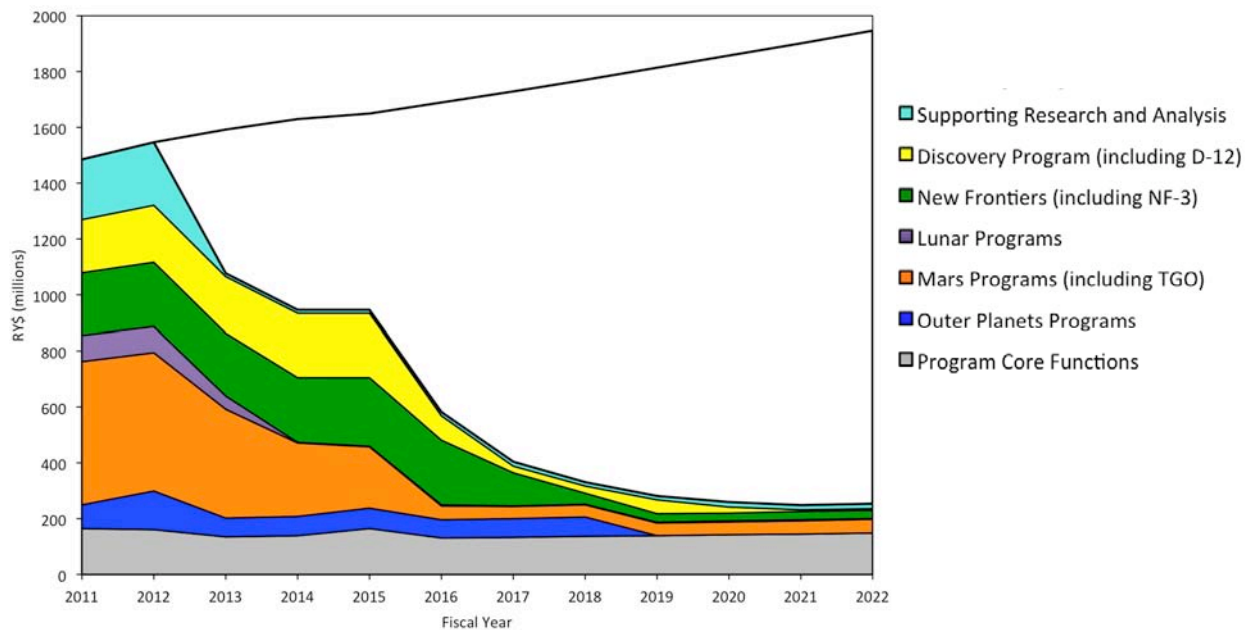

FIGURE E.1 Projected budget for the NASA Planetary Science Division (PSD), in real-year dollars. Current commitments are shown as colors; the available wedge for planning the decade is shown as the white region under the upper black line that represents the total PSD budget (budget wedge data provided by NASA Science Mission Directorate). This region is the same as the area under the solid black curve in Figure 9.1 of Chapter 9. The program of new missions described in Chapter 9 makes use of the funds depicted by the white region.

F Glossary

AAG: Astronomy and Astrophysics Research Grants program.

Abiotic: Of or relating to nonliving things; independent of life or living organisms.

Accretion: The process by which an astronomical objects increases in mass by the gravitational attraction of matter.

Aeolian: Of or relating to the wind.

Aerocapture: A technique employing a single pass through a planetary body's atmosphere to shed sufficient velocity to place a spacecraft into orbit. Thus, avoiding the need for retrorockets.

Albedo: The fraction of light that is reflected from the surface of a planetary body.

ALICE: The NASA provided ultraviolet imaging spectrometer on ESA's Rosetta comet rendezvous mission.

ALMA: Atacama Large Millimeter Array

Amino acid: Any organic compound containing an amino (NH_2) and a carboxyl (COOH). They polymerize to form peptides and proteins.

ANSMET: NSF's Antarctic Search for Meteorites program

Anthropogenic: Caused or produced by humans

AO: Adaptive optics

AO: Announcement of Opportunity

APL: Johns Hopkins University Applied Physics Laboratory

Aquifer: Any geological formation containing or conducting ground water

ARTEMIS: A NASA spacecraft designed to study the Acceleration, Reconnection, Turbulence and Electrodynamics of the Moon's Interaction with the Sun.

ASPERA: The Energetic Neutral Atoms Analyzer instrument that have flown on several ESA spacecraft.

ASRG: Advanced Stirling Radioisotope Generator.

Astrobiology: The study of the origins, evolution, and distribution of life in the universe.

AU: Astronomical unit; the mean distance from the Earth to the Sun.

Biosignature: A sign that can be interpreted as evidence of life.

PREPUBLICATION COPY—SUBJECT TO FURTHER EDITORIAL CORRECTION

F-1

Biosphere: The life zone of Earth or, by extension, another planetary body.

Biota: Living organisms of a particular place or period.

Bolometer: An instrument used to measure radiant energy.

BPO: Balloon Program Office.

Bulk composition: The makeup of a celestial body as a whole.

CAPTEM: Curation and Analysis Planning Team for Extraterrestrial Materials.

Carbide: A compound of carbon with a more electropositive element or group.

CAREER award: NSF Faculty Early Career Development Program.

CATE: Cost and Technical Evaluation.

CCSR: Cryogenic Comet Sample Return.

CDAP: Cassini Data Analysis Program.

CH₄: Methane.

Chirality: The right- or left-handedness of an asymmetric molecule.

CHNOPS: Carbon, Hydrogen, Nitrogen, Oxygen, Phosphorus, Sulphur, the six elements essential to life as we know it.

Chondrite: A stony meteorite, unaltered from its parent body

Chondrule: Round grains that make up a fraction of chondrites, formed from molten or partially molten droplets of minerals.

CIDA: The Cometary and Interstellar Dust Analyzer on NASA's Stardust spacecraft.

Circumstellar disk: A broad ring of material orbiting around a star.

CISM: Center for Integrated Space Weather Modeling

Clathrate: A chemical substance consisting of a lattice of one type of molecule (e.g., water) trapping and containing a second type of molecule (e.g., methane).

Clathration: The chemical process leading to the formation of a clathrate.

CME: Coronal Mass Ejection

CNES: Centre National d'Etudes Spatiales, the French space agency.

CNSR: Comet Nucleus Sample Return

Comparative planetology: Using the knowledge gained from the study of one planetary body to understand processes and phenomena on another.

COMPLEX: The National Research Council's Committee on Planetary and Lunar Exploration.

Corotating: To rotate jointly, as with another object or field

Covalent bond: A chemical bond formed when atoms share electrons.

Cryogenics: The branch of physics dealing with the behavior of matter at very low temperatures

Cryosphere: Portions of the planetary body where water is in solid form

Cryovolcanism: The eruption of water and other volatile materials onto the surface of a planet or moon due to internal heating.

CSSR: Comet Surface Sample Return

D/H ratio: Deuterium to hydrogen ratio

DARPA: Defense Advanced Research Projects Agency

Diagenesis: The sum of the physical, chemical, and biological changes that take place in sediments as they become consolidated into rocks, including compaction and cementation, but excluding weathering and metamorphic changes.

Differentiation: The process by which the interior of a planetary body separates into layers of different compositions.

DOE: Department of Energy

Dropsonde: A meteorological instrument package designed to be dropped from altitude in a planetary atmosphere make measurements as it falls to the planet's surface.

DSN: NASA's Deep Space Network

Dynamo: An electromagnetic process in which the movement of conductive material gives rise to a magnetic field.

Eccentricity: A measurement of the degree to which an elliptical orbit deviates from a circular orbit. An ellipse of zero eccentricity is a circle.

Ecliptic: The plane of Earth's orbit around the Sun.

EDL: Entry, Descent and Landing.

EEV: Earth Entry Vehicle.

ELT: Extremely Large Telescope.

ESA: European Space Agency.

EJSM: Europa Jupiter System Mission.

Electromagnetic induction: Production of voltage across a conductor due to a changing magnetic flux.

Emission spectrum: A spectrum composed solely or predominantly of emission lines, indicating the presence of a hot gas and a nearby source of energy.

Endogenic: Relating to a process of internal origin.

EPO: Education and Public Outreach.

EPOXI: The name of the extended mission of NASA's Deep Impact spacecraft. The name is a combination of Extrasolar Planet Observation and Characterization and Deep Impact Extended Investigation, the two phases of the extended mission.

ESMD: NASA's Exploration Systems Mission Directorate.

Exogenic: Relating to a process of external origin.

Exoplanets: Planets formed around stars other than the Sun.

Felsic rock: A class of rock which crystallizes from silicate minerals at relatively low temperatures and has a high percentage of silica.

Fischer-Tropsch reaction: A method for the synthesis of hydrocarbons and other carbon compounds. Typically, a mixture of hydrogen and carbon monoxide is reacted in the presence of an iron or cobalt catalyst to produce methane and other organic compounds, with water and carbon dioxide as by-products.

Fluvial: Relating to flowing water.

Flux: A measure of the energy or number of particles passing through a given area of surface in unit time.

FUSE: NASA's Far Ultraviolet Spectroscopic Explorer

Ga: One billion years

GCM: General Circulation Model.

GN&C: Guidance, Navigation and Control.

Gossamer ring: The outermost rings of Jupiter.

GPS: Global Positioning System.

GRAIL: NASA's Gravity Recovery and Interior Laboratory mission.

GSFC: NASA's Goddard Space Flight Center.

Gusev crater: A 144-km-wide crater located some 15 degrees south of the equator of Mars that was the landing site for Spirit, one of the Mars Exploration Rovers.

Hadley-like convection: A type of circulation pattern seen in planetary atmospheres. Warm, low-density material rises near the equator, flows towards the poles and cools. Cooler, high-density material sinks in the subtropics and flows equatorward along the surface.

H/He ratio: Hydrogen to Helium ratio.

HDO: A form of heavy water where one hydrogen atom is replaced by a deuterium atom.

Hesperian epoch: The middle of three broad time periods into which the geologic history of Mars has been divided, extending very roughly from about 3.5 to about 1.8 billion years ago.

HST: Hubble Space Telescope.

Hydrosphere: All bodies of water on a planet, as distinguished from the lithosphere and the atmosphere.

Hydrothermal: Relating to the action of hot liquid or gas within or on the surface of a planet.

IDP: Interplanetary Dust Particle.

ILN: International Lunar Network.

Informatics: The study of information processing.

Ionosphere: The region of a planet's atmosphere that is kept partially ionized by solar ultraviolet and x ray irradiation.

IR: Infrared

IRTF: Infrared Telescope Facility

ISIS: Integrated Software for Imagers and Spectrometers

Isotope: One of two or more atoms of the same element that have the same number of protons in the nucleus but a different number of neutrons.

ISS: International Space Station.

ITAR: International Traffic in Arms Regulations.

Jarosite: A yellowish or brownish mineral, a hydrous sulfate of potassium and iron, occurring in small crystals or large masses.

JAXA: Japan Aerospace Exploration Agency.

JEO: Jupiter Europa Orbiter.

JGO: Jupiter Ganymede Orbiter.

JPL: Jet Propulsion Laboratory.

KBO: Kuiper Belt Object.

Keck: Keck Observatory.

Kuiper Belt: A region of the outer solar system containing icy planetesimals distributed in a roughly circular disk some 40 to 100 AU from the Sun.

Lacustrine: Pertaining to a lake or other standing body of liquid.

LADEE: Lunar Atmosphere, Dust, and Environment Explorer.

LARS: Laboratory Analysis of Returned Samples.

Late heavy bombardment: A postulated period of enhanced impact activity in the inner solar system approximately 4.1-3.8 billion years ago. During this period, also known as the lunar cataclysm, a large number of impact basins and craters formed on the Moon.

LCROSS: Lunar Crater Observation and Sensing Satellite.

LGN: Lunar Geophysical Network.

Lidar: Light Identification Detection and Ranging; a form of optical radar and target characterization.

Lithosphere: The rigid outermost shell of a rocky planetary body.

LLNL: The Lawrence Livermore National Laboratory operated by the U.S. Department of Energy.

LRO: Lunar Reconnaissance Orbiter.

LSST: Large Synoptic Survey Telescope.

Lunar cataclysm: See **late heavy bombardment**.

Magnetohydrodynamics: The branch of physics which studies the motion of electrically conductive fluids in magnetic fields.

Magnetometry: The technique of measuring the strength and direction of a magnetic field.

Magnetosphere: The region of space in which a planet's magnetic field dominates that of the solar wind.

Magnetotail: The portion of a planetary magnetosphere pulled downstream by the solar wind.

Main sequence star: A star that is generating light and heat by the conversion of hydrogen to helium by nuclear fusion in its core.

Mantle: The part of a planet between its crust and core, composed of relatively dense materials.

MAV: Mars Ascent Vehicle.

MAVEN: Mars Atmosphere and Volatile Evolution Mission.

MAX-C: Mars Astrobiology Explorer-Cacher.

MBA: Main Belt Asteroids.

MCS: Mars Climate Sounder.

Mean motion resonance: The dynamical situation in which the ratio of the orbital periods of two orbiting objects can be expressed as the ratio of two integers.

MEPAG: Mars Exploration Program Analysis Group.

MER: Mars Exploration Rover.

Meridiani Planum: A plain located some 2 degrees south of the martian equator, in the westernmost portion of Terra Meridiani. It was the landing site for Opportunity, one of the Mars Exploration Rovers.

Meridional circulation: An atmospheric circulation pattern that is primarily oriented in the north-south plane.

MESSENGER: NASA's Mercury Surface, Space Environment, Geochemistry, and Ranging mission.

Methanogenic organism: An organism that produces methane as a byproduct of its metabolism.

MEX: ESA's Mars Express spacecraft.

MGS: Mars Global Surveyor

Microlensing: A technique used in the search for extrasolar planets that takes advantage of the gravitational lensing phenomenon.

MIDEX: NASA's program of medium-size Explorer spacecraft.

MIRO: Microwave Instrument for the Rosetta Orbiter; one of NASA's contributions to ESA's Rosetta comet rendezvous mission.

MMRTG: Multi-Mission Radioisotope Thermoelectric Generator.

Montgolfière balloon: A hot-air balloon.

MOO: Missions of Opportunity.

MRO: Mars Reconnaissance Orbiter.

MRSH: Mars Returned-Sample Handling facility.

MSL: Mars Science Laboratory.

MSR: Mars Sample Return.

MSR-L: Mars Sample Return Lander.

MSR-O: Mars Sample Return Orbiter.

N⁺: A nitrogen atom that has lost one of its electrons.

N₂: Molecular nitrogen.

NAI: NASA Astrobiology Institute.

NAIF: Navigation and Ancillary Information Facility.

NASA: National Aeronautics and Space Administration.

NEAR: NASA's Near Earth Asteroid Rendezvous.

Nebula: A cloud of gas and dust in space.

NEO: Near Earth Object.

NEP: Nuclear Electric Propulsion.

NEXT: NASA Evolutionary Xenon Thruster.

NFSS: The NRC report, *New Frontiers in the Solar System*, the first decadal survey of the planetary sciences.

NH: New Horizons

NH₃: Ammonia.

NIF: National Ignition Facility.

NIH: National Institutes of Health.

PREPUBLICATION COPY—SUBJECT TO FURTHER EDITORIAL CORRECTION

F-7

Nili Fossae region: A fracture in the surface of Mars that has been eroded and partly filled in by sediments and clay-rich ejecta from a nearby crater.

NIMS: Near-Infrared Mapping Spectrometer.

NLSI: NASA Lunar Science Institute.

NOAA: National Oceanic and Atmospheric Administration.

Noachian epoch: The oldest of three time periods into which the geologic history of Mars has been divided, spanning from about 4.1 billion to about 3.5 billion years ago.

NOAO: National Optical Astronomy Observatory.

NOSSE: The NRC report *New Opportunities in Solar System Exploration*.

NRA: NASA Research Announcement.

NRAO: National Radio Astronomy Observatory.

NRC: National Research Council.

NSF: National Science Foundation.

Nucleosynthesis: The process by which chemical elements are produced from light elements, occurring in stellar interiors and during supernovas.

Nucleotide: A class of organic molecules that play a variety of important roles in biological processes. They form, for example, the major structural subunits of DNA and RNA and serve as a source of energy for biochemical processes.

O₂: Molecular oxygen.

Obliquity: The angle between an object's rotation axis and the pole of its orbit.

Occultation: The passage of an astronomical body across the line of sight to another astronomical body of smaller angular diameter; i.e., a planet passing across the line of sight to a background star.

OLAF: On-Line Archiving Facility.

Olivine: A magnesium iron silicate mineral (FeMg)₂SiO₄.

Oort cloud: A spherical distribution of comets having semimajor axes between 1,000 and 50,000 AU, typically with low orbital eccentricity.

OPAG: Outer Planet Assessment Group.

Opportunity: The second of the two rovers of NASA's ongoing Mars Exploration Rover mission which landed on Mars on 25 January, 2004.

OPR: Outer Planets Research.

OPRP: Outer Planets Research Program.

Orbital migration: A major change in a planet's orbit around its host star, either sudden or gradual, caused by interaction with one or more other large bodies (such as neighboring planets) ,with the remnants of a protoplanetary nebula, or by some other process

Outgassing: Venting of gasses from the crust of a planetary body.

Paleoclimate: The climate of some former period of geologic time.

Pallasite: A meteorite composed primarily of olivine and metallic iron.

PCGMWC: Planetary Cartography and Geologic Mapping Working Group.

PDS: Planetary Data System.

PDS SBN: The Small Bodies Node of NASA's Planetary Data System.

Perchlorate: A salt containing the ClO_4^- ion.

PG&G: NASA's Planetary Geology and Geophysics grants program.

Phase A, B, C, D, E: Various stages of spacecraft development, including: the preliminary outline of design; definition and detailed design; development/manufacture and integration/testing; and extended operations, respectively.

Photodissociation: The breakup of molecules through exposure to light

PHX: NASA's Phoenix Mars lander.

Phyllosilicate: A family of clay mineral characterized by having the tetrahedral silicate groups linked in sheets, each group containing four oxygen atoms, three of which are shared with other groups so that the ratio of silicon atoms to oxygen atoms is two to five.

PI: Principal Investigator.

PICA: Phenolic Impregnated Carbon Ablator.

PIDDP: Planetary Instrument Definition and Development Program.

Planetary protection: Measures designed to protect the Earth and other planetary bodies from cross contamination by biological materials.

Planetesimal: A rocky and/or icy body a few kilometers to several tens of kilometers in size, which was formed in the protoplanetary nebula.

Plasma: A highly ionized gas, consisting of almost equal numbers of free electrons and positive ions.

PLD: Mars's Polar Layered Deposits.

PMDAP: Planetary Mission Data Analysis Program.

Porosity: The percentage of the total volume of a body that is made up of open spaces.

Prebiotic: Not yet alive; a chemical system that may be a precursor to life.

Presolar grains: Microscopic dust grains which existed in the interstellar cloud from which the Sun formed.

Protoplanet: A planet in the process of accretion from material in a protoplanetary disk.

Protoplanetary disk: A circumstellar disk of matter, including gas and dust, from which planets may eventually form or be in the process of forming.

²³⁸Pu: An isotope of plutonium whose physical properties make it ideally suited for use as a heat source in radioisotope power systems.

Pyroclastic: Rocks composed solely or primarily of fragments of volcanic materials.

Pyrrhotite: An unusual iron sulfide mineral with a variable iron content.

Q factor: A parameter which describes how under-damped an oscillatory system is; the higher the Q, the more slowly oscillations die out after being excited.

R&A: Research and Analysis.

Radiative balance: Accounting for all sources of ingoing and outgoing sources of radiation in a system.

Radiogenic heating: The thermal energy released by the decay of naturally occurring radioactive materials.

Radiolysis: The dissociation of molecules by ionizing radiation.

Radionuclides: A radioactive nuclide.

Redox reaction: Any of a large class of chemical reactions characterized by the reduction of one reactant and the simultaneous oxidation of another.

Regolith: The layer of dust and fragmented rocky debris which forms the uppermost surface on many planets, satellites, and asteroids. It is formed by a variety of process including meteoritic impact,

REP: Radioisotope Electric Propulsion.

Retrograde: Orbital motion or rotation in a clockwise direction as viewed from the north pole of the ecliptic or of the rotating object; i.e., in the opposite sense to the rotation of Earth and most of the other planetary bodies in the solar system.

REU: Research Experience for Undergraduates program.

ROSES: Research Opportunities in Space and Earth Sciences.

Rosetta: A European Space Agency spacecraft, launched in 2004, that will rendezvous with Comet 67P/Churyumov-Gerasimenko in 2014, flying past two asteroids on the way.

RPS: Radioisotope Power Systems.

SALMON: NASA's Stand-Alone Mission of Opportunity program.

SDT: Science Definition Team.

SED: Spectral Energy Distribution.

PREPUBLICATION COPY—SUBJECT TO FURTHER EDITORIAL CORRECTION

F-10

SEP: Solar Electric Propulsion.

Serpentinization reaction: A metamorphic process in which ultrabasic rocks react with water to create a variety of hydrous, magnesium-iron phyllosilicate minerals known collectively as serpentine. The process is endothermic and results in the liberation of hydrogen, methane, and hydrogen sulfide.

Silicate volcanism: Volcanic activity in which the lava flow consisting of silicate materials.

SMD: NASA's Science Mission Directorate.

SMEX: NASA's program of small-class Explorer spacecraft.

SNC meteorites: A group of meteorites that are thought to have come from the surface of Mars, named after the places the first three were found: Shergotty, India, Nahkla, Egypt, and Chassigny, France.

SO₂: Sulfur dioxide.

SOFIA: Stratospheric Observatory for Infrared Astronomy.

Solar nebula: The cloud of gas and dust from which our Sun, the planets, and other bodies in the solar system formed.

Solar zenith angle: The angle between the local zenith and the line of sight to the Sun.

Solid-state convection: Heat transfer by the mass motion of ductile rock or ice materials.

Sounding rocket: A relatively small research rocket capable of carrying a scientific payload to the upper atmosphere or near space on a suborbital trajectory.

South Pole-Aitken Basin: The largest, deepest, and oldest impact basin on the Moon.

SPA: South Pole-Aitken Basin.

Space weathering: Alteration of an atmosphereless planetary body's surface materials by exposure to the space environment.

Spectral resolution: A measurement of the ability to resolve the features of an electromagnetic spectrum.

Spectroscopy: The process of dissecting electromagnetic radiation from an object into its component wavelengths so as to determine its chemical composition.

SPICAM: Spectroscopy for Investigation of Characteristics of the Atmosphere of Mars; the imaging ultraviolet and infrared spectrometer on ESA's Mars Express spacecraft.

SPICAV: Spectroscopy for Investigation of Characteristics of the Atmosphere of Venus; the imaging ultraviolet and infrared spectrometer on ESA's Venus Express spacecraft.

Spirit: The first of the two rovers of NASA's ongoing Mars Exploration Rover mission which landed on Mars on 4 January, 2004.

Sputtering: A process of chemical alteration caused by atomic particles striking a surface at high speed

SSE: Solar System Exploration

Stardust: A spacecraft launched in 1999 with the objective of returning a sample of the comet Wild-2 to Earth.

STEM: Science, Technology, Engineering, and Mathematics.

Stratigraphy: A branch of geology dealing with the classification, nomenclature, correlation, and interpretation of stratified rocks.

Strike-slip fault: A plane of breakage in rock where material on either side of the break have been displaced horizontally and not vertically with respect to each other.

Sublimation: The act of changing a substance directly from a solid to a gas without it passing through a liquid stage.

Subnebula: A circumplanetary gas disk which is thought to form early on in the planetary formation process.

Superrotating: The rotation of a planet's atmosphere at a rate faster than the surface rotation.

Surface morphology: The structure and form of a particular surface

SwRI: Southwest Research Institute.

Tectonism: The processes of faulting, folding, or other deformation of the lithosphere of a planetary body, often resulting from large-scale movements below the lithosphere.

Tessera: Unique geological feature found on some of the plateau highlands on Venus and characterized by their extremely rugged topography. They are also known as complex ridged terrain and are believed to be formed when crustal stresses cause the surface to fold, buckle, and break.

TGO: Trace Gas Orbiter.

Tidal dissipation: The loss of energy from a planetary body's orbit, typically depositing energy within the body as heat.

TNO: Trans-Neptune Object; another name for a Kuiper belt object.

TPS: Thermal Protection System.

Trace gas: A gas which makes up less than 1% by volume of planets' atmosphere.

Transit: The passage of an astronomical object across the face of one of larger angular diameter.

TRL: Technology Readiness Level.

Trojan asteroids: Asteroids located near the two stable Lagrangian points of Jupiter's orbit (60° preceding and following the planet).

TSIP: Telescope System Instrumentation Program.

TSSM: Titan Saturn System Mission.

TTRV: Trojan Tour and Rendezvous.

Ultramafic: Igneous rock composed principally of mafic (magnesium and iron) minerals, such as olivine and pyroxene.

USGS: United States Geological Survey.

UV: Ultraviolet.

VEXAG: Venus Exploration Analysis Group.

VFDRM: Venus Flagship Design Reference Mission.

VIMS: Visual and Infrared Mapping Spectrometer.

VIRTIS: Visible and Infrared Thermal Imaging Spectrometer.

WISE: Venus in situ Explorer.

VITaL: Venus Intrepid Tessera Lander.

VLA: Very Large Array radio telescope.

VLBA: Very Long Baseline Array of radio telescopes.

VLT: Very Large Telescope.

VME: Venus Mobile Explorer.

Volatile: A substance that vaporizes at a relatively low temperature.

VSTDT: Venus Science and Technology Definition Team.

WMAP: Wilkinson Microwave Anisotropy Probe.

Zeta ring: The innermost ring of Uranus.

G

Mission and Technology Study Reports

Twenty-six mission studies were initiated by NASA in support of this decadal survey. Two of these, the Asteroid Interior Composition Mission and the Neptune System Mission were not completed (see Appendix D). The full text of each of the 24 studies reports there were completed is available on the attached CD.

- Mercury Lander
- Venus Mobile Explorer
- Venus Intrepid Tessera Lander
- Venus Climate Mission
- Lunar Geophysical Network
- Lunar Polar Volatiles Explorer
- Mars Astrobiology Explorer-Cacher
- Mars Sample Return Orbiter
- Mars Sample Return Lander
- Mars Sky Crane Capabilities
- Mars Geophysical Network
- Mars Polar Climate Mission
- Jupiter Europa Orbiter
- Io Observer
- Ganymede Orbiter,
- Trojan Tour and Rendezvous
- Titan Saturn System Mission
- Saturn Probe
- Enceladus Flyby-Sample Return Mission
- Enceladus Orbiter
- Titan Lake Probe
- Chiron Orbiter
- Uranus Orbiter and Probe
- Neptune-Triton-KBO Mission
- Comet Surface Sample Return

In addition four technology studies were initiated. The full text of these four study reports is also available on the attached CD.

- Near-Earth Asteroid Trajectory Opportunities in 2020-2024
- Small Fission Power System
- Saturn Ring Observer
- Comet Cryogenic Sample Return.

PREPUBLICATION COPY—SUBJECT TO FURTHER EDITORIAL CORRECTION

G-1

